









## The Fusital logo, designed by Bob Noorda

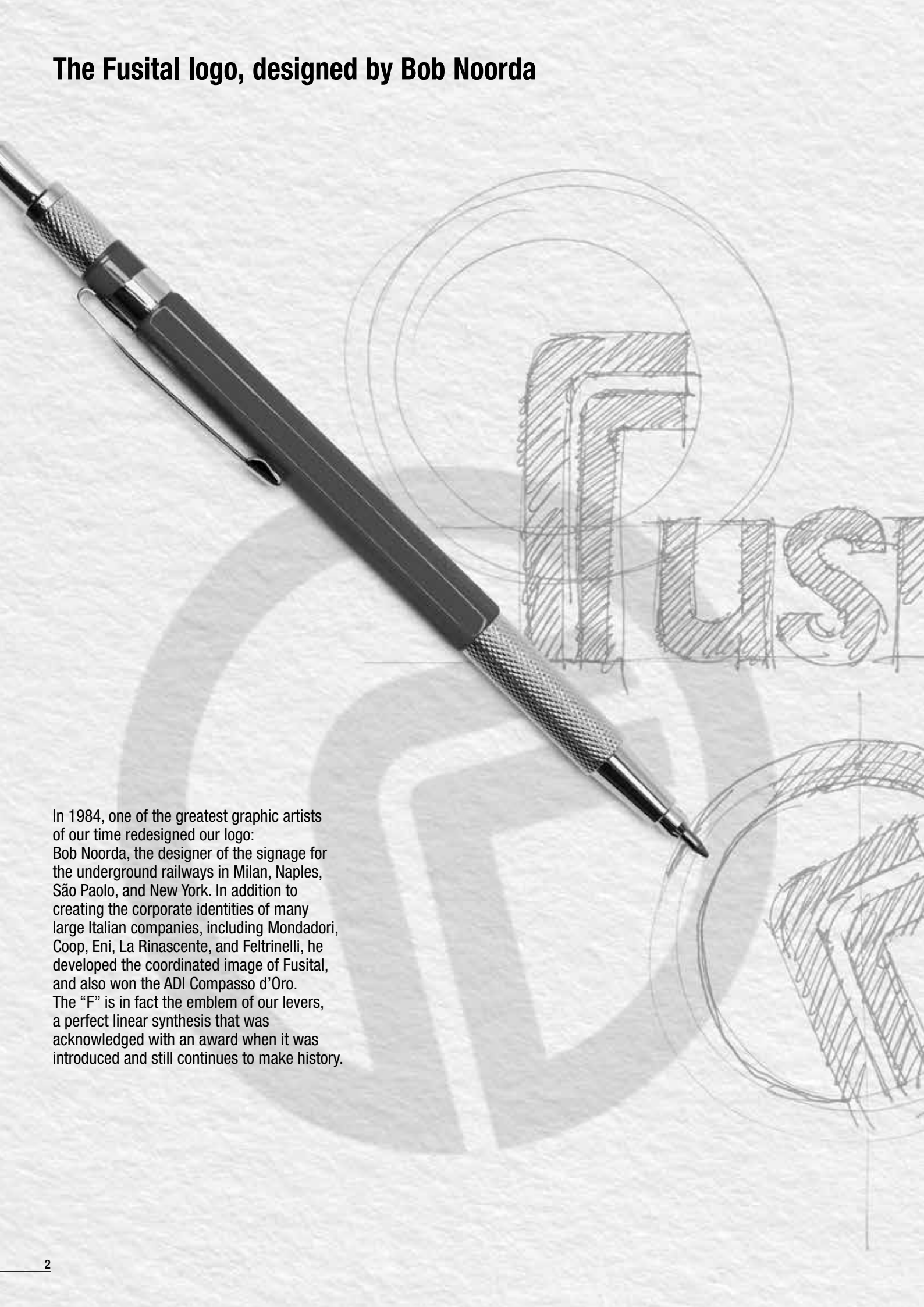

In 1984, one of the greatest graphic artists of our time redesigned our logo: Bob Noorda, the designer of the signage for the underground railways in Milan, Naples, São Paolo, and New York. In addition to creating the corporate identities of many large Italian companies, including Mondadori, Coop, Eni, La Rinascente, and Feltrinelli, he developed the coordinated image of Fusital, and also won the ADI Compasso d'Oro. The "F" is in fact the emblem of our levers, a perfect linear synthesis that was acknowledged with an award when it was introduced and still continues to make history.



Ron Arad  
Gae Aulenti  
Dante O. Benini e Luca Gonzo

Cini Boeri  
Achille Castiglioni

Antonio Citterio

Carlo Colombo

Norman Foster

Franco Frattini

Doriana e Massimiliano Fuksas

Michael Graves

Gregotti Associati

Philip Johnson/Alan Ritchie Architects

Hans Kollhoff

Léon Krier

Vico Magistretti

Angelo Mangiarotti

Renzo Mongiardino

Jean Nouvel

Fabio Novembre

Gustav Peichl

Renzo Piano

Andrée Putman

Aldo Rossi

Ettore Sotsass

Sotsass Associati

Chi Wing Lo

Marco Zanuso

... just to name few



design

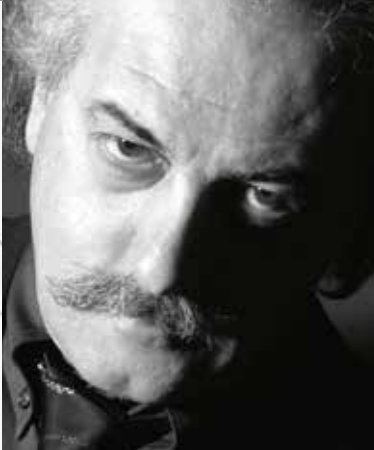
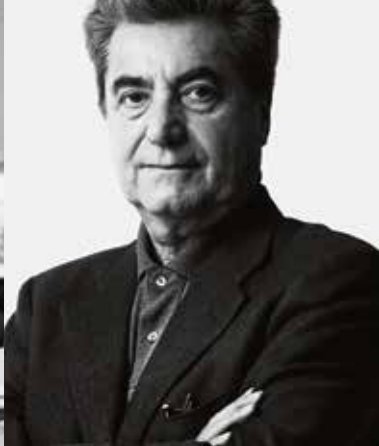





## Index

Presto	pag. 18
4 You	pag. 19
Finishes	pag. 20
Door Levers	pag. 22
Door Knobs	pag. 56
European version and slim rosette options	pag. 62
Door Pulls	pag. 66
Handlesets	pag. 80
Pocket Doors	pag. 90
Stainless Steel Door Levers	pag. 94
Stainless Steel Door Knobs	pag. 102
Stainless Steel Door Pulls	pag. 106
Mortise Locks	pag. 112
Deadlock	pag. 126
Deadbolts	pag. 130
Privacy Bolts	pag. 136
Thumb turn options	pag. 140
Escutcheon with Deadbolts	pag. 142
Multi-Point trim	pag. 148
Miscellaneous parts	pag. 160
List of door thicknesses	pag. 178
Certifications	pag. 182
General sales terms and conditions	pag. 186



Traditions are ingrained in our memory.

In 2006, the company changed its name and in 2008 it joined the ASSA ABLOY Group. Innovation and technology profoundly changed its industrial capacity, but the **design culture** remains the same. Each handle has a spirit infused with the philosophy of the architect who designed it. Because this is part of **our heritage**, it is the spark that keeps the passion for work alive. It is the **originality of an idea** that is embodied in every product day after day. It is the deep, unconditional **love of Quality**, with a capital Q. This might carry a worn-out meaning today, but for us it is still the founding value that makes each Fusital creation pure and innovative, a **testimony of design trends** and the changing times, inspiring those who look at it and touch it, surprising with its extraordinary ingenuity.

**PURE, INNOVATIVE,  
INSPIRING,  
SMART.  
IN SHORT, QUALITY**

If not created by an icon of design, it is not a Fusital item. This is the best way to recognize the originality of our levers. Starting with the architect's pencil, Fusital follows the creation process up to the final product, including verification of the object's production compatibility. Each step features close **sharing between Fusital and the designer**, from 3D resin samples to the metal model up to the creation of the prototype. At this point, following the fundamental industrialization process, the final product is created. Fusital is the synthesis of rigorous **Made in Italy manufacturing** and designs from only the **greatest architects** who have presented memorable icons to environments, cities, and landscapes **around the world**. And each signature "betrays" its philosophy, culture and origin. It is the mirror of each designer's thought. It is as if each lever were a fingerprint. And as such, each **lever is one of a kind**.

**OUR  
SIGNATURE  
SHOWCASES  
OUR DNA**

Designer levers. This phrase has accompanied Fusital **since 1976**, the year the company was founded. At that time, the idea of combining functionality and aesthetics in a single object **designed by the greatest international architects** was taking shape. The creator is not simply the artist who designs or the company that produces. These two worlds are combined and expressed through constant attention and the exchange of ideas. Everyone works together to **create a truly simple object** that, due to its simplicity, is difficult to conceive and reinvent. It is the meticulous organization of a structure that constantly maintains and updates this priceless flow of information, experience, ideas, and creations. The creator is the culture that **blends the magic of design into masterful technical preparation**. It is the materialization of a concept through the most precise production. It is a company that, for more than 40 years, has been recognised worldwide for design and quality.

**A TIMELESS STORY,  
ITALIAN  
THROUGH  
AND THROUGH**

**AN EXTRAORDINARY  
VISION THAT  
BORDERS  
ON PERFECTION**

design  
nature

# Door Levers



**H 311**

Serie **MB Sei**  
design Mario Bellini  
page 24



**H 315**

Serie **G Novanta**  
design Pierluigi Cerri  
page 25



**H 317**

Serie **AC Novantuno**  
design Antonio Citterio  
page 26



**H 326**

Serie **AC1 Novantacinque**  
design Antonio Citterio  
page 27



**H 327**

Serie **AC2 Novantacinque**  
design Antonio Citterio  
page 28



**H 329**

Serie **RB Novantacinque**  
design Taller Design  
Ricardo Bofill  
page 29



**H 330**

Serie **T Novantasette**  
design Matteo Thun  
page 30



**H 334**

Serie **NF Novantotto**  
design Foster+Partners  
page 31



**H 335**

Serie **RM Novantotto**  
design Richard Meier  
page 32



**H 338**

Serie **YK Duemila**  
design Yoshimi Kono  
page 33



**H 343**

Serie **JP Duemila**  
design John Pawson  
page 34



**H 348**

Serie **DC Duemiladue**  
design David Chipperfield  
Architects  
page 35



**H 350**

Serie **CA Duemiladue**  
design Cerri & Associati  
page 36



**H 354**

Serie **FOG Duemilaquattro**  
design Frank O. Gehry  
page 37



**H 356**

Serie **ZH Duemilacinque**  
design Zaha Hadid with  
Woody Yao  
page 38



**H 359**

Serie **SOM New York Duemilasette**  
design Skidmore, Owings & Merrill  
page 39

fusital



Fast shipment levers, see page 18 for further details.



# Door Levers



**H 361**

Serie **AC Duemilasei**  
design Antonio Citterio  
page 40



**H 364**

Serie **MB Duemilanove**  
design Mario Bellini  
page 41



**H 367**

Serie **GV Duemilanove**  
design Giancarlo Vegni  
page 42



**H 368**

Serie **CA Duemilanove**  
design Cerri & Associati  
page 43



**H 369**

Serie **EG Duemilanove**  
design Eri Goshen  
page 44



**H 370**

Serie **MDF Duemiladieci**  
design Massimiliano &  
Doriana Fuksas  
page 45



**H 372**

Serie **EG Duemilaudici**  
design Eri Goshen  
page 46



**H 376**

Serie **GV Duemilaquattordici**  
design Giancarlo Vegni  
page 47



**H 377**

Serie **SL Duemilasedici**  
design Steve Leung  
page 48



**H 378**

Serie **YP Duemiladiciotto**  
design Yabu Pushelberg  
page 49



**H 379**

Serie **AC Duemilaventi**  
design Antonio Citterio  
page 50



**H 380**

Serie **AC1 Duemilaventi**  
design Antonio Citterio  
page 51



**H 381**

Serie **KAN Duemilaventi**  
design Khalid Al Najjar  
page 52



**H 382**

Serie **CCD Duemilaventi**  
design Joe Cheng  
page 53



**H 383**

Serie **PW Duemilaventuno**  
design Perkins&Will  
page 54



**H 384**

Serie **CR Duemilaventuno**  
design CetraRuddy  
page 55

ital brass

# Door Knobs

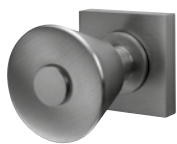

**K 377**

Serie **SL Duemilasedici**  
design *Steve Leung*  
page 58



**K 378**

Serie **YP Duemiladiciotto**  
design *Yabu Pushelberg*  
page 59



**K 383**

Serie **PW Duemilaventuno**  
design *Perkins&Will*  
page 60

# Door Pulls



**K 352**

Serie **RM Novantotto**  
design *Richard Meier*  
page 68



**K 353**

Serie **RB Novantacinque**  
design *Taller Design Ricardo Bofill*  
page 69



**K 356**

Serie **JP Duemila**  
design *John Pawson*  
page 70



**K 358**

Serie **CA Duemiladue**  
design *Cerri & Associati*  
page 71



**K 368**

Serie **AC4 Duemilasei**  
design *Antonio Citterio*  
with *Toan Nguyen*  
page 72



**K 377**

Serie **SL Duemilasedici**  
design *Steve Leung*  
page 73



**K 378**

Serie **YP Duemiladiciotto**  
design *Yabu Pushelberg*  
page 74



**K 379**

Serie **AC Duemilaventi**  
design *Antonio Citterio*  
page 75

# Door Pulls



**K 380**

Serie **AC1 Duemilaventi**  
design Antonio Citterio  
page 76



**K 381**

Serie **KAN Duemilaventi**  
design Khalid Al Najjar  
page 77



**K 383**

Serie **PW Duemilaventuno**  
design Perkins&Will  
page 78

# Handlesets



**K 1810**

design Valli Workshop  
page 82



**K 1868**

design Valli Workshop  
page 84



**K 1869**

design Valli Workshop  
page 86



**K 1870**

design Valli Workshop  
page 88

# Pocket Doors



**K 3012**

Serie **AC3 Duemilaquattro**  
design Antonio Citterio  
with Toan Nguyen  
page 92



**K 3014**

Serie **AC3 Duemilaquattro**  
design Antonio Citterio  
with Toan Nguyen  
page 93



# Stainless Steel Door Levers



## H 5008

Serie **Himalaya**  
*design Ricardo Bofill*  
page 96



## H 5014

Serie **Bernina**  
*design Valli workshop*  
page 97



## H 5015

Serie **K2**  
*design Antonio Citterio*  
page 98



## H 5017

Serie **Gottardo**  
*design Hans Kollhoff*  
page 100

# Stainless Steel Door Knobs



## K 5301

*design Fusital workshop*  
page 104



## K 5302

*design Fusital workshop*  
page 105

Stain



Fast shipment levers, see page 18 for further details.

# Stainless Steel Door Pulls



## **P 5405**

**Serie Himalaya**  
*design Taller Design*  
*Ricardo Bofill*  
page 108



## **P 5406**

**Serie K2**  
*design Antonio Citterio*  
page 109



## **P 5408**

**Serie K2**  
*design Antonio Citterio*  
page 110

fusital

Stainless Steel

# How to specify

## 1 LEVER / KNOB MODEL

Choose from our collection of levers / knobs (ex. H 384 or K 377).

## 2 TRIM OPTION

Choose among the options at page 16 and 17.

## 3 FUNCTION

PGE Passage  
 PCY Privacy  
 DMY Dummy  
 ML-XXX Mortise lock (Different functions available. Check details at page 115)  
 101 Deadbolt single cylinder  
 102 Deadbolt double cylinder  
 105 Privacy bolt

## 4 HANDING

RH, LH, RHR or LHR.  
 The hand of the door is always determined from the outside.  
 Follow the diagram below.

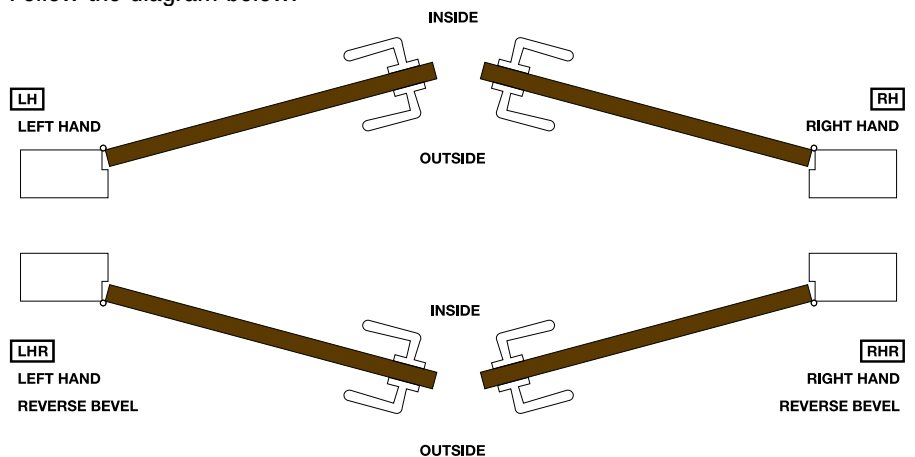

## 5 FINISH

Standard finishes are indicated on each lever page. Special finishes are available upon request for an upcharge. Choose one of the finishes at pages 20-21.

## 6 BACKSET

Choose between these standard options:  
 2.3/8" or 2.3/4" for tubular application  
 2.1/2" or 2.3/4" for mortise application

## 7 DOOR THICKNESS

To be specified. 1.3/4" is considered standard.  
 Up to 3" thick door available (Upcharges apply).

## 8 MISCELLANEOUS

Note any special keying information, or special instruction.

Examples:	1	2	3	4	5	6	7	8
Tubular set	H 378	RP	PCY	RH	26	2.3/8"	1.3/4"	Full lip strike
Mortise lock	H 377	RS50	ML-F	LHR	16	2.3/4"	2.1/4"	KA Cylinders
Deadbolt / Privacy bolt	105	RQ	-	-	26D	2.3/4"	1.3/4"	Less exterior
Multi-Point	See specification details at page 150							

## STANDARD CONFIGURATIONS

The configuration on each catalog page is considered STANDARD. If the requested configuration is not included, it might be produced upon special request and for the upcharges at page 15. Tubular latches standard backsets: 2.3/4" and 2.3/8" Mortise lock standard backsets: 2.3/4" and 2.1/2". Standard door thickness: 1.3/4".

The tubular sets are supplied with T-strikes. Full lip strikes can be supplied upon request at no extra charge.



# Upcharges

<b>1</b> <b>KEYING CHARGES:</b>	KA – keyed alike (5 pins) – <b>NO CHARGE</b> KA is not available on Multi-Point cylinders.										
<b>2</b> <b>DROP SHIP CHARGES:</b>	<b>\$5.00 NET</b> applies to drop ship orders.										
<b>3</b> <b>RUSH DELIVERY CHARGES:</b>	<b>\$30.00 NET</b> applies to all orders requested to be shipped within 48 hours.										
<b>4</b> <b>FINISHES:</b>	<p><i>Split finishes:</i> + <b>\$ 20.00 NET</b> to the highest priced finish indicated.</p> <p><i>Non-standard finishes:</i>            + <b>\$ 100.00 NET</b> to the highest priced finish for levers, deadbolts, privacy bolts, pulls, multi point and pocket door trims            + <b>\$ 50.00 NET</b> to the highest priced finish for single dummies and deadlocks</p> <p><i>Anti-microbial finishes (BIOCOTE details at page 21):</i>            + <b>\$ 150.00 NET</b> to the highest priced finish for levers, deadbolts, privacy bolts, pulls, multi point and pocket door trims            + <b>\$ 70.00 NET</b> to the highest priced finish for single dummies and deadlocks</p>										
<b>5</b> <b>BACKSET:</b>	<p><i>Narrow mortise lock backset (&lt; 2.1/2"):</i> + <b>\$ 250.00 LIST</b> to the price of the standard sets            Special backset request: Call for details and pricing</p>										
<b>6</b> <b>UPSIDE DOWN MORTISE LOCK:</b>	+ <b>\$ 100.00 LIST</b> to the price of the standard mortise lock sets										
<b>7</b> <b>MAGNETIC LOCKS:</b>	<p><i>Tubular latches:</i> + <b>\$30.00 LIST</b> to the price of the standard sets  <i>American mortise locks:</i>            + <b>\$200.00 LIST</b> for no thumb-turn functions            + <b>\$250.00 LIST</b> for thumb-turn functions</p>										
<b>8</b> <b>DOOR THICKNESS:</b>	<table border="0" style="width: 100%;"> <tr> <td style="vertical-align: top; padding-right: 20px;"><i>Tubular latches and bolts:</i></td> <td><i>Mortise lock and multi-point (Multi-point only accommodates up to 2.1/4" thick door):</i></td> </tr> <tr> <td>2.1/4" Thick door: + <b>\$ 50.00 LIST</b></td> <td>2.1/4" Thick door: + <b>\$ 70.00 LIST</b></td> </tr> <tr> <td>2.1/2" Thick door: + <b>\$ 70.00 LIST</b></td> <td>2.1/2" Thick door: + <b>\$ 90.00 LIST</b></td> </tr> <tr> <td>3" Thick door: + <b>\$ 90.00 LIST</b></td> <td>3" Thick door: + <b>\$ 120.00 LIST</b></td> </tr> <tr> <td></td> <td>&gt; 3" Thick door: + <b>\$150.00 LIST</b></td> </tr> </table>	<i>Tubular latches and bolts:</i>	<i>Mortise lock and multi-point (Multi-point only accommodates up to 2.1/4" thick door):</i>	2.1/4" Thick door: + <b>\$ 50.00 LIST</b>	2.1/4" Thick door: + <b>\$ 70.00 LIST</b>	2.1/2" Thick door: + <b>\$ 70.00 LIST</b>	2.1/2" Thick door: + <b>\$ 90.00 LIST</b>	3" Thick door: + <b>\$ 90.00 LIST</b>	3" Thick door: + <b>\$ 120.00 LIST</b>		> 3" Thick door: + <b>\$150.00 LIST</b>
<i>Tubular latches and bolts:</i>	<i>Mortise lock and multi-point (Multi-point only accommodates up to 2.1/4" thick door):</i>										
2.1/4" Thick door: + <b>\$ 50.00 LIST</b>	2.1/4" Thick door: + <b>\$ 70.00 LIST</b>										
2.1/2" Thick door: + <b>\$ 70.00 LIST</b>	2.1/2" Thick door: + <b>\$ 90.00 LIST</b>										
3" Thick door: + <b>\$ 90.00 LIST</b>	3" Thick door: + <b>\$ 120.00 LIST</b>										
	> 3" Thick door: + <b>\$150.00 LIST</b>										
<b>9</b> <b>NON-STANDARD ROSETTES:</b>	<p><i>Single Dummy</i>            Non-listed RQ and RQS (square rosette): + <b>\$ 55.00 LIST</b> to the RP/RPS price</p> <p><i>Full set</i>            Non-listed RQ and RQS (square rosette): + <b>\$ 110.00 LIST</b> to the RP/RPS price  <b>RS</b> = Small European rosettes – Same price as standard American rosettes  <b>RS/Round</b> rosettes (45mm, 50mm, 55mm) – Same price as RP  <b>RSQ/Square</b> rosettes (45mm, 50mm, 55mm) – Same price as RQ            Privacy function on small rosette = Requires the purchase of a Passage set and an additional Privacy Bolt  <b>RSB</b> = Slim rosettes – full pricing at page 65  <b>RE</b> = Rectangular rosettes (for tubular latches only) + <b>\$ 30.00 LIST</b> to the RQ prices</p>										
<b>10</b> <b>NON-STANDARD PLATES AND THUMB PIECES:</b>	<p>Narrow plates <b>NEP, NES, NER</b> and <b>NERS</b> = Same price as standard plates EP, EPS, ER, ERS            Thumb piece change on ER/Rectangular plate and EP/Oval plate (ex. use of the K1225): + <b>\$ 100.00 LIST</b></p>										
<b>11</b> <b>DUMMY SET ADAPTOR (for 2.1/8" pre-drilled doors only):</b>	<p>X003/1 back to back application: + <b>\$ 75.00 LIST</b> to DMY price            X003/2 single application: + <b>\$ 90.00 LIST</b> to DMY price</p>										
<b>12</b> <b>STRIKE PLATES:</b>	<p>ASA Strike plates: + <b>\$ 60.00 LIST</b>            Custom strike plates available upon request. Call for pricing.</p>										

# Trim options - Rosettes

Any lever of the catalog can be matched with any type of rosette, choose from the options below:

## 1. Configurations for pre-drilled doors (2.1/8" bore)



### Round 65mm (2.9/16")

**RP** / Round rosette brass

**RPS** / Round rosette stainless steel

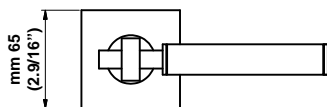

### Square 65mm (2.9/16")

**RQ** / Square rosette brass

**RQS** / Square rosette stainless steel

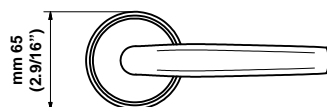

### Traditional 65mm (2.9/16")

**RT** / Traditional rosette brass

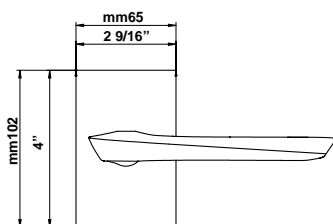

### Rectangular 65x102 mm (2.9/16"x4")

**RE** / Rectangular rosette brass

(Only available in brass material)

## 2. Configurations for non pre-drilled doors

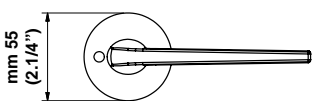

### Round 55mm (2.1/4")

**RS55** / Round rosette brass

(Fits a privacy pin)

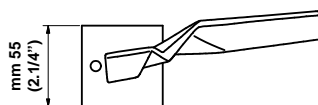

### Square 55mm (2.1/4")

**RSQ55** / Square rosette brass

(Fits a privacy pin)

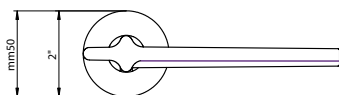

### Round 50mm (2")

**RS50** / Round rosette brass

**RSB<sup>1</sup>** / Round slim rosette brass

**RSS** / Round rosette stainless steel

(Requires privacy bolt)

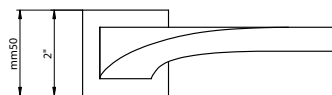

### Square 50mm (2")

**RSQ50** / Square rosette brass

**RSBQ<sup>1</sup>** / Square slim rosette brass

**RSSQ** / Square rosette stainless steel

(Requires privacy bolt)

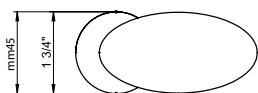

### Round 45mm (1.3/4")

**RS45** / Round rosette brass

(Requires privacy bolt)

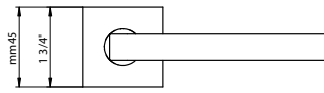

### Square 45mm (1.3/4")

**RSQ45** / Square rosette brass

(Requires privacy bolt)

<sup>1</sup> Slim rosettes details at page 65

# Trim options - Escutcheon Plates

Any lever/knob in the catalog can be matched with any type of escutcheon plate, choose from the options below:

## 1. Standard size plates

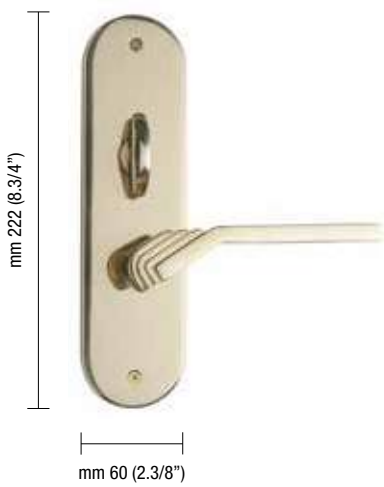

**EP Oval Escutcheon**

**Solid brass**

Oval escutcheon shown  
with thumbturn



**ET Traditional Escutcheon**

**Solid brass**

Traditional escutcheon shown  
with thumbturn



**ER Rectangular Escutcheon Solid brass**

**ERS Rectangular Escutcheon Stainless steel**

Rectangular escutcheon shown  
with thumbturn

## 2. Narrow plates



**NEP Narrow Oval Escutcheon**

**Solid brass**



**NER Narrow Rectangular Escutcheon**

**Solid brass**



**NES Narrow Escutcheon**

**Stainless steel**

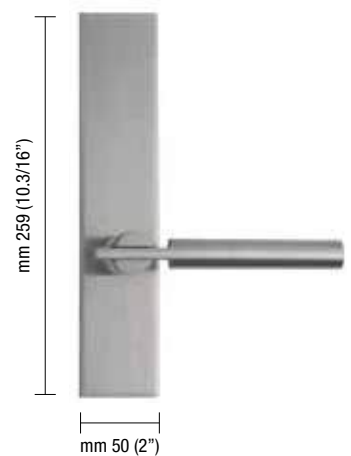

**NERS Narrow Rectangular Escutcheon**

**Stainless steel**

Valli&Valli has selected some of its most popular levers in its collection to be **continuously in stock** for fast shipment.

These levers are recognized throughout the catalog by the PRESTO logo indicated on corresponding page.

The levers of the PRESTO Collection are meant to ship **within 3-5 business days** from the order confirmation. Contact our customer service for more information.

The PRESTO items are available under the following conditions:

- Maximum 10 sets per order. Contact our customer service for any request higher than this quantity.
- Available functions: Tubular passage, privacy and dummy (mix of different functions per order).  
Entry mortise lock 2.3/4" backset
- Presto stock is available in the following standard finishes only: 14, 15, 26 & 26D and 32D (as indicated per lever page).



## H 311

Serie **Sei MB**  
*design Mario Bellini*  
page 24



## H 329

Serie **RB Novantacinque**  
*design Taller Design*  
*Ricardo Bofill*  
page 29



## H 361

Serie **AC 4 Duemilasei**  
*design Antonio Citterio*  
page 40



## H 5015

Serie **K2**  
*design Antonio Citterio*  
page 98

Valli&Valli is proud to present a new service of lever customization on both finishes and designs.

Any lever in this catalog can be customized to customers' request and it will be especially manufactured **4 YOU**.

Our custom services are grouped in 3 categories:

## 1 SPECIAL FINISHES FROM THE VALLI&VALLI RANGE

Any lever made of solid brass in this catalog can be customized to a different non-standard finish from the list at pages 20-21.

Average lead time: 8-10 weeks from the order confirmation.

Upcharge of \$100.00 NET to the most expensive standard finish of the same lever.

## 2 SPECIAL FINISHES FROM A THIRD PARTY FINISH SAMPLE

Special finishes not included on pages 20-21, can also be produced under the following conditions:

- Approval of a finish sample by the R&D department in Italy
- Approval of the upcharges to be discussed at the time of the request

Average production lead time: 8-10 weeks from the confirmation of the order

Price to be agreed based on the requested finish.

## 3 CUSTOM DESIGN ALTERATION AND NEW CREATION

Custom lever designs or design modification (ex. Hammered lever grips, wooden or leather inserts, etc.) can be produced upon request, with a Minimum Order Quantity.

Any custom design is subject to the following:

- Design submittal
- Technical evaluation by the R&D department in Italy
- Approval of the technical drawings by the customer
- Approval of the sample. The customer will be charged for any expenses related to the samples' production and tooling.

Average production lead time: 10-12 weeks from the confirmation of the order Price varies based on the requested design.

Please see below some examples of custom designs created at Valli&Valli.

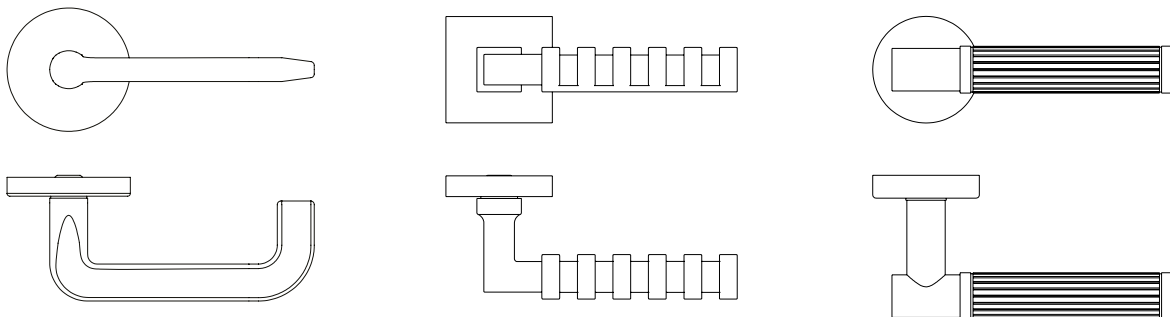

Ask our customer service for other special custom designs already produced for large buildings and private houses across all USA.



# Finishes

## Face and strike

26 / POLISHED CHROME

26D / SATIN CHROME

03 / POLISHED BRASS

03 / POLISHED BRASS

03D / SATIN BRASS

03D / SATIN BRASS

03D / SATIN BRASS

03 / POLISHED BRASS

06 / ANTIQUE BRASS

03 / POLISHED BRASS

03D / SATIN BRASS

06 / ANTIQUE BRASS

06B / BRUNITO

06 / ANTIQUE BRASS

26 / POLISHED CHROME

26D / SATIN CHROME

## Levers and knobs

26 / POLISHED CHROME - C

26D / SATIN CHROME - CA

★ 03 / POLISHED BRASS - A

03-PVD / POLISHED BRASS PVD - A-PVD

★ 03D / SATIN BRASS - AB

03D-PVD / SATIN BRASS PVD - AB-PVD

★ 03M / MATT BRASS - AC

17 / OROLUX (BRASS FINISH) - AD

★ 24D / ANTIQUE SATIN GOLD - AE

UNLACQUERED BRASS - B

★ ANTIQUE NATURAL BRASS - BA

★ BA / ANTIQUE BRASS - BB

★ 06B / BRUNITO - BC

★ 06A / ANTICATO - BD

26-PVD / POLISHED CHROME PVD - C-PVD

26D-PVD / SATIN CHROME PVD - CA-PVD

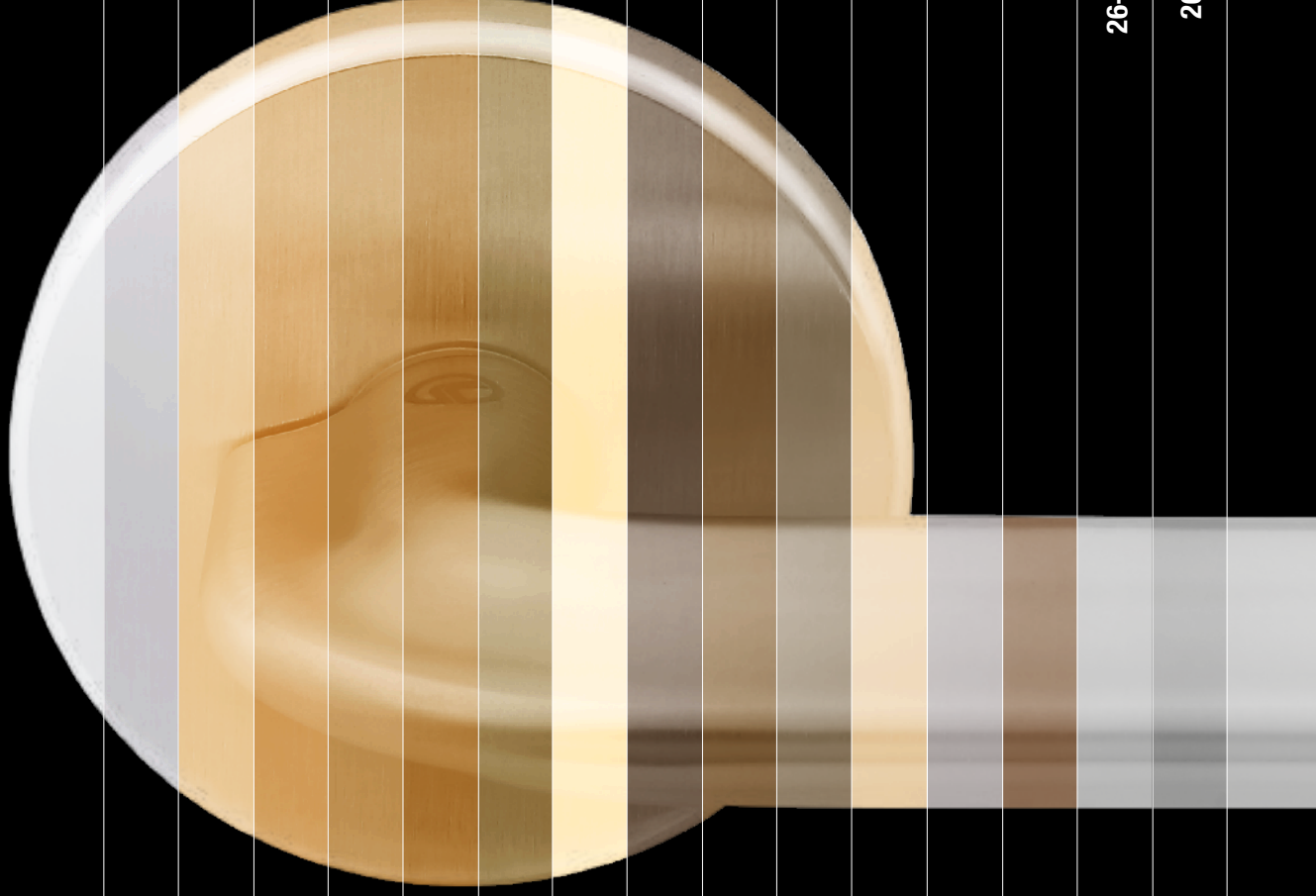

14 / POLISHED NICKEL	32 / POLISHED STAINLESS STEEL - N1
15 / SATIN NICKEL	32D / SATIN STAINLESS STEEL - N2
14 / POLISHED NICKEL	★ 14 / POLISHED NICKEL - D
15 / SATIN NICKEL	★ 15 / SATIN NICKEL - DA
15 / SATIN NICKEL	★ 15A / ANTIQUE NICKEL - DB
15 / SATIN NICKEL	★ 18 / BLACK NICKEL - DC
06B / BRUNITO	10S-PVD / SATIN BRONZE PVD - E-PVD
06B / BRUNITO	★ 10S / SATIN BRONZE - E
06B / BRUNITO	★ 06M / MATT BRONZE - EA
06B / BRUNITO	★ 56 / DARK BRONZE - ED
06 / ANTIQUE BRASS	BRONZE PVD - EE-PVD
16 / DULL BLACK	★ 16 / DULL BLACK - F
22M / MATT WHITE	★ 22M / MATT WHITE - FB
15 / SATIN NICKEL	55 / TITANIUM PVD - H
SATIN COPPER	★ MATT COPPER - IA
17A / POLISHED BLACK NICKEL	★ 17A / POLISHED BLACK NICKEL - L

★ In cooperation with **BioCote®**, we offer a specific anti-microbial surface treatment that ensures protection of the levers against bacteria colonies. This transparent anti-microbial treatment is available on request on the selected finishes marked with the star. Lead time varies based on the finish selected. For prices please check the upcharges at page 15



door levers

# H 311 Serie MB Sei

design Mario Bellini



## GROUP II Matching elements

- Pg 112** Mortise lock functions
- Pg 130** Deadbolts
- Pg 136** Privacy Bolts
- Pg 142** Escutcheons with deadbolts
- Pg 148** Multi-Point Trim functions

Window lever available in the same design  
Call for pricing



### Sizes/Misure

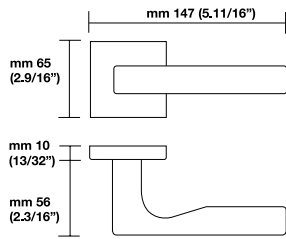

### Escutcheon options/Opzioni

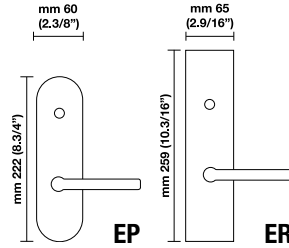

See page 18  
for details



See page 65  
for details

Conversions from metric to U.S. measurements are approximate.

### Retail Price

Finish	Round	Square	PGE	PCY	DMY R/L Single	ML-F ENTRY
14	<b>RP</b>	<b>RQ</b>	\$ 657.00	\$ 678.00	\$ 319.00	\$ 1,123.00
15	<b>RP</b>	<b>RQ</b>	\$ 665.00	\$ 684.00	\$ 322.00	\$ 1,123.00
17A	<b>RP</b>	<b>RQ</b>	\$ 731.00	\$ 752.00	\$ 354.00	\$ 1,123.00
26	<b>RP</b>	<b>RQ</b>	\$ 581.00	\$ 594.00	\$ 284.00	\$ 1,123.00
26D	<b>RP</b>	<b>RQ</b>	\$ 613.00	\$ 628.00	\$ 297.00	\$ 1,123.00
			\$ 791.00	\$ 811.00	\$ 394.00	\$ 1,286.00
			\$ 743.00	\$ 755.00	\$ 396.00	\$ 1,286.00
			\$ 817.00	\$ 863.00	\$ 435.00	\$ 1,286.00
			\$ 693.00	\$ 711.00	\$ 347.00	\$ 1,286.00
			\$ 733.00	\$ 754.00	\$ 371.00	\$ 1,286.00

Finish	Oval	Rectangular	PGE	PCY	DMY R/L Single	DMY R/L Pair	ML-F ENTRY
26	<b>EP</b>	<b>ER</b>	\$ 762.00	\$ 772.00	\$ 375.00	\$ 702.00	\$ 1,076.00
26D	<b>EP</b>	<b>ER</b>	\$ 762.00	\$ 772.00	\$ 375.00	\$ 702.00	\$ 1,076.00
			\$ 795.00	\$ 808.00	\$ 398.00	\$ 749.00	\$ 1,111.00
			\$ 795.00	\$ 808.00	\$ 398.00	\$ 749.00	\$ 1,111.00

The options listed above are considered standard.  
Non-standard options are available upon request.

For more options on **Rosettes and Escutcheon plates** see pages 16-17.

For more options on **Finishes** see pages 20-21.

**RE = Rectangular rosettes** available for tubular latch application only. Add + \$ 30.00 LIST to the price of the RQ

**Upcharges** apply for the following special options:

- Extra thick door (> 2")
- Non-standard rosettes (rosettes not listed above)
- Non-standard finishes (finishes not listed above)
- Split finishes

See page 15 for pricing. Exclusions may apply.



# H 315 Serie G Novanta

design Pierluigi Cerri

## GROUP I Matching elements

- Pg 112 Mortise lock functions
- Pg 130 Deadbolts
- Pg 136 Privacy Bolts
- Pg 142 Escutcheons with deadbolts
- Pg 148 Multi-Point Trim functions

Window lever available in the same design  
Call for pricing



### Sizes/Misure

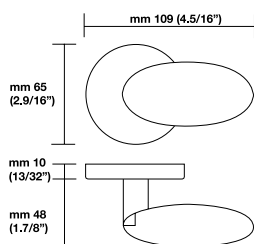

### Escutcheon options/Opzioni

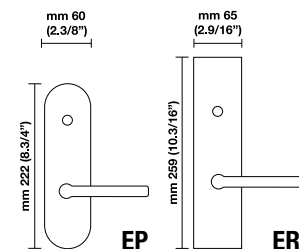

Conversions from metric to U.S. measurements are approximate.



See page 65  
for details

### Retail Price

Finish	Round	Square	PGE	PCY	DMY R/L Single	ML-F ENTRY
03/White	<b>RP</b>		\$ 447.00	\$ 477.00	\$ 217.00	\$ 1,018.00
		<b>RQ</b>	\$ 557.00	\$ 587.00	\$ 272.00	\$ 1,146.00
26/White	<b>RP</b>		\$ 439.00	\$ 471.00	\$ 217.00	\$ 1,018.00
		<b>RQ</b>	\$ 549.00	\$ 581.00	\$ 272.00	\$ 1,146.00

Finish	Oval	Rectangular	PGE	PCY	DMY R/L Single	DMY R/L Pair	ML-F ENTRY
26/White	<b>EP</b>		\$ 632.00	\$ 644.00	\$ 305.00	\$ 562.00	\$ 960.00
		<b>ER</b>	\$ 679.00	\$ 691.00	\$ 341.00	\$ 621.00	\$ 995.00

**Note:** Lever made of porcelain, not suitable for commercial use.

For more options on **Rosettes and Escutcheon plates** see pages 16-17.

For more options on **Finishes** see pages 20-21.

**RE = Rectangular rosettes** available for tubular latch application only. Add + \$ 30.00 LIST to the price of the RQ

**Upcharges** apply for the following special options:

- Extra thick door (> 2")
- Non-standard rosettes (rosettes not listed above)
- Non-standard finishes (finishes not listed above)
- Split finishes

See page 15 for pricing. Exclusions may apply.

The options listed above are considered standard.  
Non-standard options are available upon request.

# H 317 Serie AC Novantuno

design Antonio Citterio



## GROUP I Matching elements

- Pg 112** Mortise lock functions
- Pg 130** Deadbolts
- Pg 136** Privacy Bolts
- Pg 142** Escutcheons with deadbolts
- Pg 148** Multi-Point Trim functions

Window lever available in the same design  
Call for pricing



### Sizes/Misure

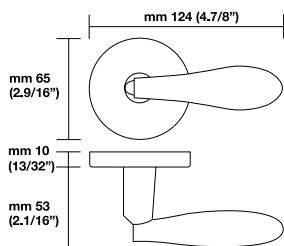

### Escutcheon options/Opzioni

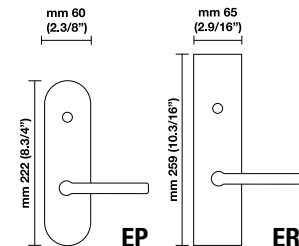

Conversions from metric to U.S. measurements are approximate.



See page 65  
for details

### Retail Price

Finish	Round	Square	PGE	PCY	DMY R/L Single	ML-F ENTRY
26	<b>RP</b>	<b>RQ</b>	\$ 447.00	\$ 458.00	\$ 210.00	\$ 1,018.00
26D	<b>RP</b>	<b>RQ</b>	\$ 557.00	\$ 568.00	\$ 265.00	\$ 1,146.00
			\$ 457.00	\$ 477.00	\$ 217.00	\$ 1,018.00
			\$ 567.00	\$ 587.00	\$ 272.00	\$ 1,146.00

Finish	Oval	Rectangular	PGE	PCY	DMY R/L Single	DMY R/L Pair	ML-F ENTRY
26	<b>EP</b>	<b>ER</b>	\$ 632.00	\$ 644.00	\$ 305.00	\$ 562.00	\$ 960.00
26D	<b>EP</b>	<b>ER</b>	\$ 679.00	\$ 691.00	\$ 341.00	\$ 621.00	\$ 995.00
			\$ 632.00	\$ 644.00	\$ 305.00	\$ 562.00	\$ 960.00
			\$ 679.00	\$ 691.00	\$ 341.00	\$ 621.00	\$ 995.00

The options listed above are considered standard.  
Non-standard options are available upon request.

For more options on **Rosettes and Escutcheon plates**  
see pages 16-17.

For more options on **Finishes** see pages 20-21.

**RE = Rectangular rosettes** available for tubular latch  
application only. Add + \$ 30.00 LIST to the price of the RQ

**Upcharges** apply for the following special options:

- Extra thick door (> 2")
- Non-standard rosettes (rosettes not listed above)
- Non-standard finishes (finishes not listed above)
- Split finishes

See page 15 for pricing. Exclusions may apply.

# H 326 Serie AC1 Novantacinque

design Antonio Citterio



## GROUP I Matching elements

- Pg 112** Mortise lock functions
- Pg 130** Deadbolts
- Pg 136** Privacy Bolts
- Pg 142** Escutcheons with deadbolts
- Pg 148** Multi-Point Trim functions

Window lever available in the same design  
Call for pricing



### Sizes/Misure

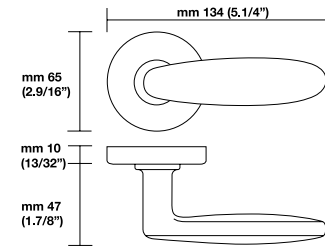

### Escutcheon options/Opzioni

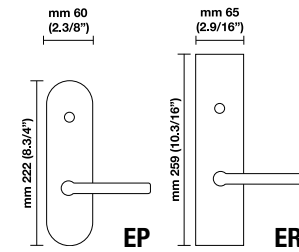

Conversions from metric to U.S. measurements are approximate.



See page 65  
for details

### Retail Price

Finish	Round	Square	PGE	PCY	DMY R/L Single	ML-F ENTRY
03	<b>RP</b>	<b>RQ</b>	\$ 341.00	\$ 368.00	\$ 164.00	\$ 1,018.00
			\$ 451.00	\$ 478.00	\$ 219.00	\$ 1,146.00
26D	<b>RP</b>	<b>RQ</b>	\$ 349.00	\$ 370.00	\$ 166.00	\$ 1,018.00
			\$ 459.00	\$ 480.00	\$ 221.00	\$ 1,146.00

Finish	Oval	Rectangular	PGE	PCY	DMY R/L Single	DMY R/L Pair	ML-F ENTRY
	<b>EP</b>		\$ 632.00	\$ 644.00	\$ 305.00	\$ 562.00	\$ 960.00
26D		<b>ER</b>	\$ 679.00	\$ 691.00	\$ 341.00	\$ 621.00	\$ 995.00

The options listed above are considered standard.  
Non-standard options are available upon request.

For more options on **Rosettes and Escutcheon plates**  
see pages 16-17.  
For more options on **Finishes** see pages 20-21.

**RE = Rectangular rosettes** available for tubular latch  
application only. Add + \$ 30.00 LIST to the price of the RQ

**Upcharges** apply for the following special options:  
• Extra thick door (> 2")  
• Non-standard rosettes (rosettes not listed above)  
• Non-standard finishes (finishes not listed above)  
• Split finishes  
See page 15 for pricing. Exclusions may apply.

# H 327 Serie AC2 Novantacinque

design Antonio Citterio



## GROUP I Matching elements

- Pg 112** Mortise lock functions
- Pg 130** Deadbolts
- Pg 136** Privacy Bolts
- Pg 142** Escutcheons with deadbolts
- Pg 148** Multi-Point Trim functions

Window lever available in the same design  
Call for pricing



### Sizes/Misure

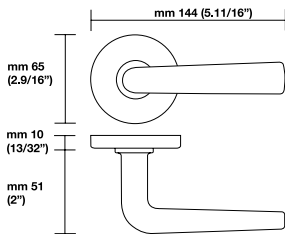

### Escutcheon options/Opzioni

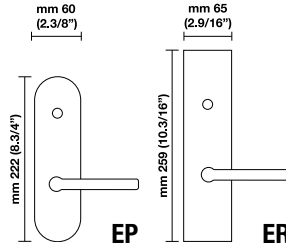

Conversions from metric to U.S. measurements are approximate.



See page 65  
for details

### Retail Price

Finish	Round	Square	PGE	PCY	DMY R/L Single	ML-F ENTRY
03	RP	RQ	\$ 345.00	\$ 367.00	\$ 163.00	\$ 1,018.00
26D	RP	RQ	\$ 454.00	\$ 477.00	\$ 218.00	\$ 1,146.00
			\$ 350.00	\$ 370.00	\$ 167.00	\$ 1,018.00
			\$ 460.00	\$ 480.00	\$ 222.00	\$ 1,146.00

Finish	Oval	Rectangular	PGE	PCY	DMY R/L Single	DMY R/L Pair	ML-F ENTRY
	EP		\$ 632.00	\$ 644.00	\$ 305.00	\$ 562.00	\$ 960.00
26D		ER	\$ 679.00	\$ 691.00	\$ 341.00	\$ 621.00	\$ 995.00

The options listed above are considered standard.  
Non-standard options are available upon request.

For more options on **Rosettes and Escutcheon plates** see pages 16-17.

For more options on **Finishes** see pages 20-21.

**RE = Rectangular rosettes** available for tubular latch application only. Add + \$ 30.00 LIST to the price of the RQ

**Upcharges** apply for the following special options:

- Extra thick door (> 2")
- Non-standard rosettes (rosettes not listed above)
- Non-standard finishes (finishes not listed above)
- Split finishes

See page 15 for pricing. Exclusions may apply.

# H 329 Serie RB Novantacinque

design Taller Design Ricardo Boffill



## GROUP II Matching elements

- Pg 112** Mortise lock functions
- Pg 130** Deadbolts
- Pg 136** Privacy Bolts
- Pg 142** Escutcheons with deadbolts
- Pg 148** Multi-Point Trim functions

Window lever available in the same design  
Call for pricing



### Sizes/Misure

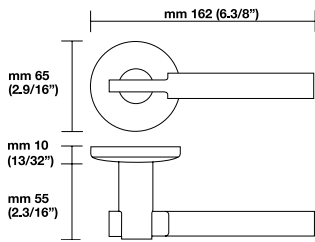

### Escutcheon options/Opzioni

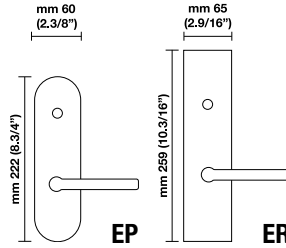

See page 18  
for details



See page 65  
for details

Conversions from metric to U.S. measurements are approximate.

### Retail Price

Finish	Round	Square	PGE	PCY	DMY R/L Single	ML-F ENTRY
03M	<b>RP</b>		\$ 538.00	\$ 564.00	\$ 259.00	\$ 1,123.00
		<b>RQ</b>	\$ 650.00	\$ 667.00	\$ 326.00	\$ 1,286.00
26/26D*	<b>RP</b>		\$ 538.00	\$ 564.00	\$ 259.00	\$ 1,123.00
		<b>RQ</b>	\$ 650.00	\$ 667.00	\$ 326.00	\$ 1,286.00

Finish	Oval	Rectangular	PGE	PCY	DMY R/L Single	DMY R/L Pair	ML-F ENTRY
	<b>EP</b>		\$ 762.00	\$ 772.00	\$ 375.00	\$ 702.00	\$ 1,076.00
26/26D*		<b>ER</b>	\$ 795.00	\$ 808.00	\$ 398.00	\$ 749.00	\$ 1,111.00

\* The lever grip is satin, the shank is polished. The rosette/escutcheon is polished.

For more options on **Rosettes and Escutcheon plates** see pages 16-17.  
For more options on **Finishes** see pages 20-21.

**RE = Rectangular rosettes** available for tubular latch application only. Add + \$ 30.00 LIST to the price of the RQ

**Upcharges** apply for the following special options:

- Extra thick door (> 2")
  - Non-standard rosettes (rosettes not listed above)
  - Non-standard finishes (finishes not listed above)
  - Split finishes
- See page 15 for pricing. Exclusions may apply.

The options listed above are considered standard.  
Non-standard options are available upon request.



# H 330 Serie T Novantasette

design Matteo Thun



## GROUP I Matching elements

- Pg 112** Mortise lock functions
- Pg 130** Deadbolts
- Pg 136** Privacy Bolts
- Pg 142** Escutcheons with deadbolts
- Pg 148** Multi-Point Trim functions

Window lever available in the same design  
Call for pricing

### Sizes/Misure

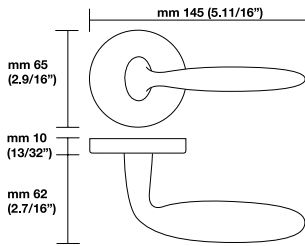

### Escutcheon options/Opzioni

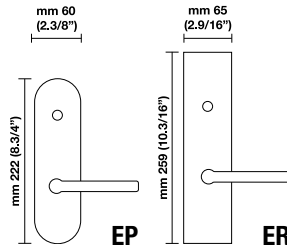





Conversions from metric to U.S. measurements are approximate.



See page 65  
for details

### Retail Price

Finish	Round	Square	PGE	PCY	DMY R/L Single	ML-F ENTRY
						
03M	<b>RP</b>	<b>RQ</b>	\$ 378.00	\$ 399.00	\$ 180.00	\$ 1,018.00
			\$ 488.00	\$ 510.00	\$ 235.00	\$ 1,146.00
26D	<b>RP</b>	<b>RQ</b>	\$ 396.00	\$ 415.00	\$ 187.00	\$ 1,018.00
			\$ 506.00	\$ 525.00	\$ 242.00	\$ 1,146.00

Finish	Oval	Rectangular	PGE	PCY	DMY R/L Single	DMY R/L Pair	ML-F ENTRY
							
26D	<b>EP</b>		\$ 632.00	\$ 644.00	\$ 305.00	\$ 562.00	\$ 960.00
		<b>ER</b>	\$ 679.00	\$ 691.00	\$ 341.00	\$ 621.00	\$ 995.00

The options listed above are considered standard.  
Non-standard options are available upon request.

For more options on **Rosettes and Escutcheon plates** see pages 16-17.

For more options on **Finishes** see pages 20-21.

**RE = Rectangular rosettes** available for tubular latch application only. Add + \$ 30.00 LIST to the price of the RQ

**Upcharges** apply for the following special options:

- Extra thick door (> 2")
- Non-standard rosettes (rosettes not listed above)
- Non-standard finishes (finishes not listed above)
- Split finishes

See page 15 for pricing. Exclusions may apply.

# H 334 Serie NF Novantotto

design Foster+Partners



## GROUP I Matching elements

- Pg 112** Mortise lock functions
- Pg 130** Deadbolts
- Pg 136** Privacy Bolts
- Pg 142** Escutcheons with deadbolts
- Pg 148** Multi-Point Trim functions

Window lever available in the same design  
Call for pricing

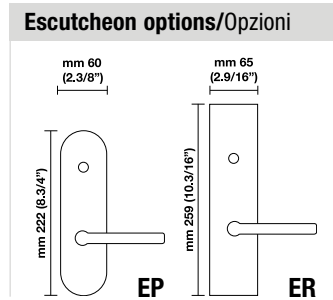
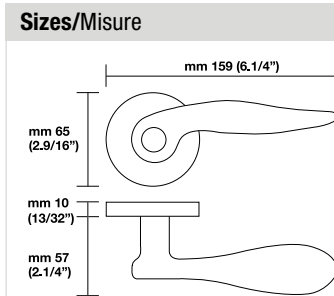

Conversions from metric to U.S. measurements are approximate.

## Retail Price

Finish	Round	Square	PGE	PCY	DMY R/L Single	ML-F ENTRY
03	<b>RP</b>	<b>RQ</b>	\$ 490.00	\$ 507.00	\$ 233.00	\$ 1,018.00
			\$ 599.00	\$ 617.00	\$ 288.00	\$ 1,146.00
26D	<b>RP</b>	<b>RQ</b>	\$ 495.00	\$ 510.00	\$ 236.00	\$ 1,018.00
			\$ 605.00	\$ 620.00	\$ 291.00	\$ 1,146.00

Finish	Oval	Rectangular	PGE	PCY	DMY R/L Single	DMY R/L Pair	ML-F ENTRY
	<b>EP</b>		\$ 632.00	\$ 644.00	\$ 305.00	\$ 562.00	\$ 960.00
26D		<b>ER</b>	\$ 679.00	\$ 691.00	\$ 341.00	\$ 621.00	\$ 995.00

The options listed above are considered standard.  
Non-standard options are available upon request.

For more options on **Rosettes and Escutcheon plates**  
see pages 16-17.  
For more options on **Finishes** see pages 20-21.

**RE = Rectangular rosettes** available for tubular latch  
application only. Add + \$ 30.00 LIST to the price of the RQ

**Upcharges** apply for the following special options:  
• Extra thick door (> 2")  
• Non-standard rosettes (rosettes not listed above)  
• Non-standard finishes (finishes not listed above)  
• Split finishes  
See page 15 for pricing. Exclusions may apply.

# H 335 Serie RM Novantotto

design Richard Meier



## GROUP II Matching elements

- Pg 112** Mortise lock functions
- Pg 130** Deadbolts
- Pg 136** Privacy Bolts
- Pg 142** Escutcheons with deadbolts
- Pg 148** Multi-Point Trim functions

Window lever available in the same design  
Call for pricing

### Sizes/Misure

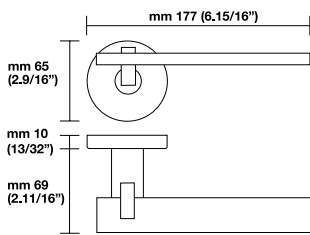

### Escutcheon options/Opzioni

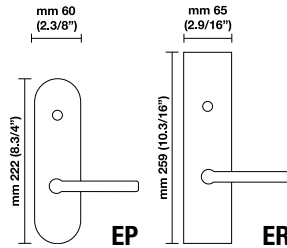

Conversions from metric to U.S. measurements are approximate.

### Retail Price

Finish	Round	Square	PGE	PCY	DMY R/L Single	ML-F ENTRY
26	<b>RP</b>	<b>RQ</b>	\$ 657.00	\$ 695.00	\$ 322.00	\$ 1,123.00
26D	<b>RP</b>	<b>RQ</b>	\$ 732.00	\$ 765.00	\$ 357.00	\$ 1,123.00
			\$ 767.00	\$ 805.00	\$ 377.00	\$ 1,286.00
			\$ 842.00	\$ 875.00	\$ 412.00	\$ 1,286.00

Finish	Oval	Rectangular	PGE	PCY	DMY R/L Single	DMY R/L Pair	ML-F ENTRY
26	<b>EP</b>	<b>ER</b>	\$ 762.00	\$ 772.00	\$ 375.00	\$ 702.00	\$ 1,076.00
26D	<b>EP</b>	<b>ER</b>	\$ 762.00	\$ 772.00	\$ 375.00	\$ 702.00	\$ 1,076.00
			\$ 795.00	\$ 808.00	\$ 398.00	\$ 749.00	\$ 1,111.00
			\$ 795.00	\$ 808.00	\$ 398.00	\$ 749.00	\$ 1,111.00

The options listed above are considered standard.  
Non-standard options are available upon request.

For more options on **Rosettes and Escutcheon plates** see pages 16-17.  
For more options on **Finishes** see pages 20-21.

**RE = Rectangular rosettes** available for tubular latch application only. Add + \$ 30.00 LIST to the price of the RQ

**Upcharges** apply for the following special options:  
 • Extra thick door (> 2")  
 • Non-standard rosettes (rosettes not listed above)  
 • Non-standard finishes (finishes not listed above)  
 • Split finishes  
 See page 15 for pricing. Exclusions may apply.

# H 338 Serie YK Duemila

design Yoshimi Kono



## GROUP I Matching elements

- Pg 112** Mortise lock functions
- Pg 130** Deadbolts
- Pg 136** Privacy Bolts
- Pg 142** Escutcheons with deadbolts
- Pg 148** Multi-Point Trim functions

Window lever available in the same design  
Call for pricing

### Sizes/Misure

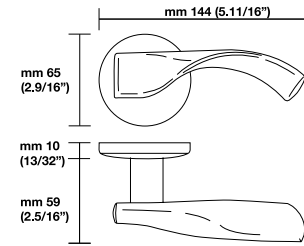

### Escutcheon options/Opzioni

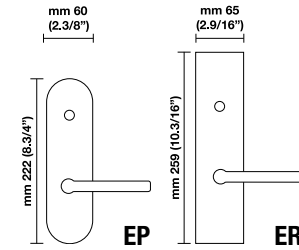

Conversions from metric to U.S. measurements are approximate.



See page 65  
for details

### Retail Price

Finish	Round	Square	PGE	PCY	DMY R/L Single	ML-F ENTRY
14	RP	RQ	\$ 452.00	\$ 464.00	\$ 215.00	\$ 1,018.00
			\$ 562.00	\$ 574.00	\$ 270.00	\$ 1,146.00
15	RP	RQ	\$ 441.00	\$ 453.00	\$ 207.00	\$ 1,018.00
			\$ 551.00	\$ 563.00	\$ 262.00	\$ 1,146.00
16	RP	RQ	\$ 427.00	\$ 439.00	\$ 203.00	\$ 1,018.00
			\$ 537.00	\$ 549.00	\$ 258.00	\$ 1,146.00
26D	RP	RQ	\$ 410.00	\$ 425.00	\$ 193.00	\$ 1,018.00
			\$ 520.00	\$ 535.00	\$ 248.00	\$ 1,146.00

Finish	Oval	Rectangular	PGE	PCY	DMY R/L Single	DMY R/L Pair	ML-F ENTRY
26D	EP	ER	\$ 632.00	\$ 644.00	\$ 305.00	\$ 562.00	\$ 960.00
			\$ 679.00	\$ 691.00	\$ 341.00	\$ 621.00	\$ 995.00

The options listed above are considered standard.  
Non-standard options are available upon request.

For more options on **Rosettes and Escutcheon plates**  
see pages 16-17.  
For more options on **Finishes** see pages 20-21.

**RE = Rectangular rosettes** available for tubular latch  
application only. Add + \$ 30.00 LIST to the price of the RQ

**Upcharges** apply for the following special options:  
• Extra thick door (> 2")  
• Non-standard rosettes (rosettes not listed above)  
• Non-standard finishes (finishes not listed above)  
• Split finishes  
See page 15 for pricing. Exclusions may apply.

# H 343 Serie JP Duemila

design John Pawson



## GROUP II Matching elements

- Pg 112** Mortise lock functions
- Pg 130** Deadbolts
- Pg 136** Privacy Bolts
- Pg 142** Escutcheons with deadbolts
- Pg 148** Multi-Point Trim functions

Window lever available in the same design  
Call for pricing



### Sizes/Misure

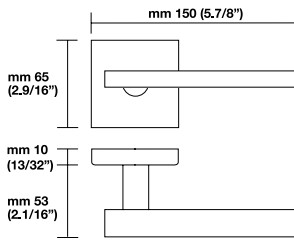

### Escutcheon options/Opzioni

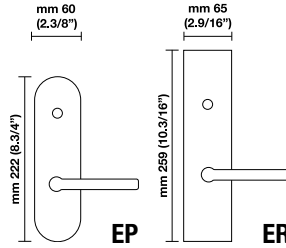

Conversions from metric to U.S. measurements are approximate.



See page 65  
for details

### Retail Price

Finish	Round	Square	PGE	PCY	DMY R/L Single	ML-F ENTRY
14	<b>RP</b>	<b>RQ</b>	\$ 594.00	\$ 632.00	\$ 296.00	\$ 1,123.00
15	<b>RP</b>	<b>RQ</b>	\$ 576.00	\$ 608.00	\$ 285.00	\$ 1,123.00
26	<b>RP</b>	<b>RQ</b>	\$ 528.00	\$ 554.00	\$ 259.00	\$ 1,123.00
26D	<b>RP</b>	<b>RQ</b>	\$ 550.00	\$ 579.00	\$ 271.00	\$ 1,123.00
			\$ 731.00	\$ 765.00	\$ 371.00	\$ 1,286.00
			\$ 698.00	\$ 724.00	\$ 357.00	\$ 1,286.00
			\$ 642.00	\$ 674.00	\$ 324.00	\$ 1,286.00
			\$ 679.00	\$ 710.00	\$ 345.00	\$ 1,286.00

Finish	Oval	Rectangular	PGE	PCY	DMY R/L Single	DMY R/L Pair	ML-F ENTRY
26	<b>EP</b>	<b>ER</b>	\$ 762.00	\$ 772.00	\$ 375.00	\$ 702.00	\$ 1,076.00
26D	<b>EP</b>	<b>ER</b>	\$ 762.00	\$ 772.00	\$ 375.00	\$ 702.00	\$ 1,076.00
			\$ 795.00	\$ 808.00	\$ 398.00	\$ 749.00	\$ 1,111.00
			\$ 795.00	\$ 808.00	\$ 398.00	\$ 749.00	\$ 1,111.00

The options listed above are considered standard.  
Non-standard options are available upon request.

For more options on **Rosettes and Escutcheon plates**  
see pages 16-17.  
For more options on **Finishes** see pages 20-21.

**RE = Rectangular rosettes** available for tubular latch  
application only. Add + \$ 30.00 LIST to the price of the RQ

**Upcharges** apply for the following special options:  
• Extra thick door (> 2")  
• Non-standard rosettes (rosettes not listed above)  
• Non-standard finishes (finishes not listed above)  
• Split finishes  
See page 15 for pricing. Exclusions may apply.



# H 348 Serie DC Duemiladue

design David Chipperfield Architects



## GROUP I Matching elements

- Pg 112** Mortise lock functions
- Pg 130** Deadbolts
- Pg 136** Privacy Bolts
- Pg 142** Escutcheons with deadbolts
- Pg 148** Multi-Point Trim functions

Window lever available in the same design  
Call for pricing



### Sizes/Misure

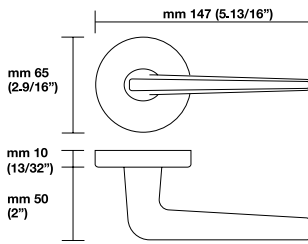

### Escutcheon options/Opzioni

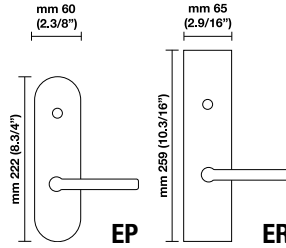

Conversions from metric to U.S. measurements are approximate.



See page 65  
for details

### Retail Price

Finish	Round	Square	PGE	PCY	DMY R/L Single	ML-F ENTRY
14	RP	RQ	\$ 456.00	\$ 471.00	\$ 218.00	\$ 1,018.00
			\$ 566.00	\$ 581.00	\$ 273.00	\$ 1,146.00
15	RP	RQ	\$ 506.00	\$ 520.00	\$ 244.00	\$ 1,018.00
			\$ 616.00	\$ 630.00	\$ 299.00	\$ 1,146.00
16	RP	RQ	\$ 467.00	\$ 492.00	\$ 230.00	\$ 1,018.00
			\$ 577.00	\$ 602.00	\$ 285.00	\$ 1,146.00
26	RP	RQ	\$ 408.00	\$ 431.00	\$ 195.00	\$ 1,018.00
			\$ 518.00	\$ 541.00	\$ 250.00	\$ 1,146.00
26D	RP	RQ	\$ 412.00	\$ 434.00	\$ 197.00	\$ 1,018.00
			\$ 522.00	\$ 544.00	\$ 252.00	\$ 1,146.00

Finish	Oval	Rectangular	PGE	PCY	DMY R/L Single	DMY R/L Pair	ML-F ENTRY
26	EP	ER	\$ 632.00	\$ 644.00	\$ 305.00	\$ 562.00	\$ 960.00
			\$ 679.00	\$ 691.00	\$ 341.00	\$ 621.00	\$ 995.00
26D	EP	ER	\$ 632.00	\$ 644.00	\$ 305.00	\$ 562.00	\$ 960.00
			\$ 679.00	\$ 691.00	\$ 341.00	\$ 621.00	\$ 995.00

For more options on **Rosettes and Escutcheon plates** see pages 16-17.

For more options on **Finishes** see pages 20-21.

**RE = Rectangular rosettes** available for tubular latch application only. Add + \$ 30.00 LIST to the price of the RQ

**Upcharges** apply for the following special options:

- Extra thick door (> 2")
- Non-standard rosettes (rosettes not listed above)
- Non-standard finishes (finishes not listed above)
- Split finishes

See page 15 for pricing. Exclusions may apply.

The options listed above are considered standard.  
Non-standard options are available upon request.

# H 350 Serie CA Duemiladue

design Cerri & Associati



## GROUP III Matching elements

- Pg 112** Mortise lock functions
- Pg 130** Deadbolts
- Pg 136** Privacy Bolts
- Pg 142** Escutcheons with deadbolts
- Pg 148** Multi-Point Trim functions

Window lever available in the same design  
Call for pricing



### Sizes/Misure

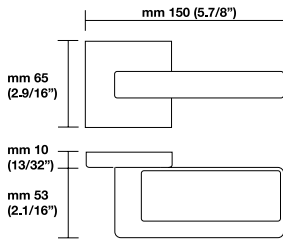

### Escutcheon options/Opzioni

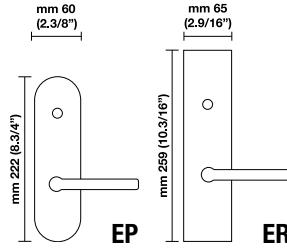

Conversions from metric to U.S. measurements are approximate.

### Retail Price

Finish	Round	Square	PGE	PCY	DMY R/L Single	ML-F ENTRY
14	<b>RP</b>	<b>RQ</b>	\$ 1,069.00	\$ 1,082.00	\$ 520.00	\$ 1,497.00
			\$ 1,196.00	\$ 1,214.00	\$ 600.00	\$ 1,625.00
15	<b>RP</b>	<b>RQ</b>	\$ 1,069.00	\$ 1,082.00	\$ 520.00	\$ 1,497.00
			\$ 1,190.00	\$ 1,205.00	\$ 596.00	\$ 1,625.00
26	<b>RP</b>	<b>RQ</b>	\$ 938.00	\$ 952.00	\$ 456.00	\$ 1,497.00
			\$ 1,053.00	\$ 1,066.00	\$ 525.00	\$ 1,625.00
26D	<b>RP</b>	<b>RQ</b>	\$ 945.00	\$ 958.00	\$ 460.00	\$ 1,494.00
			\$ 1,069.00	\$ 1,085.00	\$ 539.00	\$ 1,625.00

Finish	Oval	Rectangular	PGE	PCY	DMY R/L Single	DMY R/L Pair	ML-F ENTRY
26	<b>EP</b>	<b>ER</b>	\$ 1,100.00	\$ 1,146.00	\$ 539.00	\$ 1,030.00	\$ 1,439.00
			\$ 1,146.00	\$ 1,158.00	\$ 562.00	\$ 1,088.00	\$ 1,474.00
26D	<b>EP</b>	<b>ER</b>	\$ 1,100.00	\$ 1,146.00	\$ 539.00	\$ 1,030.00	\$ 1,439.00
			\$ 1,146.00	\$ 1,158.00	\$ 562.00	\$ 1,088.00	\$ 1,474.00

The options listed above are considered standard.  
Non-standard options are available upon request.

For more options on **Rosettes and Escutcheon plates** see pages 16-17.

For more options on **Finishes** see pages 20-21.

**RE = Rectangular rosettes** available for tubular latch application only. Add + \$ 30.00 LIST to the price of the RQ

**Upcharges** apply for the following special options:

- Extra thick door (> 2")
- Non-standard rosettes (rosettes not listed above)
- Non-standard finishes (finishes not listed above)
- Split finishes

See page 15 for pricing. Exclusions may apply.

# H 354 Serie FOG Duemilaquattro

design Frank O. Gehry

## GROUP IV Matching elements

- Pg 112** Mortise lock functions
- Pg 130** Deadbolts
- Pg 136** Privacy Bolts
- Pg 142** Escutcheons with deadbolts
- Pg 148** Multi-Point Trim functions

Window lever available in the same design  
Call for pricing



### Sizes/Misure

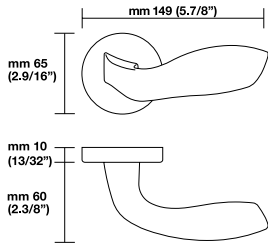

### Escutcheon options/Opzioni

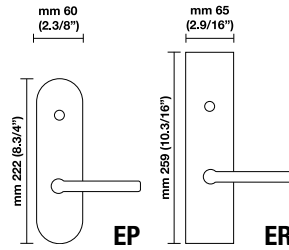

Conversions from metric to U.S. measurements are approximate.

### Retail Price

Finish	Round	Square	PGE	PCY	DMY R/L Single	ML-F ENTRY
26	<b>RP</b>	<b>RQ</b>	\$ 945.00	\$ 969.00	\$ 474.00	\$ 1,544.00
26D	<b>RP</b>	<b>RQ</b>	\$ 1,055.00	\$ 1,079.00	\$ 529.00	\$ 1,684.00
			\$ 988.00	\$ 997.00	\$ 496.00	\$ 1,544.00
			\$ 1,098.00	\$ 1,127.00	\$ 551.00	\$ 1,684.00

Finish	Oval	Rectangular	PGE	PCY	DMY R/L Single	DMY R/L Pair	ML-F ENTRY
26	<b>EP</b>	<b>ER</b>	\$ 1,170.00	\$ 1,193.00	\$ 586.00	\$ 1,111.00	\$ 1,497.00
26D	<b>EP</b>	<b>ER</b>	\$ 1,229.00	\$ 1,240.00	\$ 609.00	\$ 1,158.00	\$ 1,532.00
			\$ 1,170.00	\$ 1,193.00	\$ 586.00	\$ 1,111.00	\$ 1,497.00
			\$ 1,229.00	\$ 1,240.00	\$ 609.00	\$ 1,158.00	\$ 1,532.00

The options listed above are considered standard.  
Non-standard options are available upon request.

For more options on **Rosettes and Escutcheon plates** see pages 16-17.  
For more options on **Finishes** see pages 20-21.

**RE = Rectangular rosettes** available for tubular latch application only. Add + \$ 30.00 LIST to the price of the RQ

**Upcharges** apply for the following special options:

- Extra thick door (> 2")
- Non-standard rosettes (rosettes not listed above)
- Non-standard finishes (finishes not listed above)
- Split finishes

See page 15 for pricing. Exclusions may apply.

# H 356 Serie ZH Duemilacinque



design Zaha Hadid with Woody Yao

## GROUP IV Matching elements

- Pg 112** Mortise lock functions
- Pg 130** Deadbolts
- Pg 136** Privacy Bolts
- Pg 142** Escutcheons with deadbolts
- Pg 148** Multi-Point Trim functions

Window lever available in the same design  
Call for pricing



### Sizes/Misure

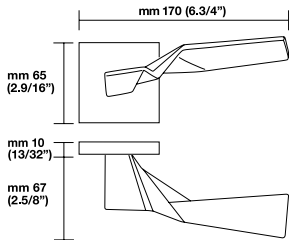

### Escutcheon options/Opzioni

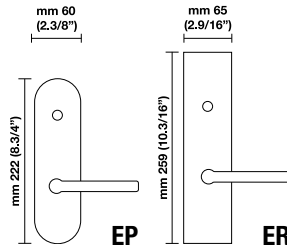

Conversions from metric to U.S. measurements are approximate.



See page 65  
for details

### Retail Price

Finish	Round	Square	PGE	PCY	DMY R/L Single	ML-F ENTRY
26	<b>RP</b>	<b>RQ</b>	\$ 1,007.00	\$ 1,033.00	\$ 498.00	\$ 1,544.00
26D	<b>RP</b>	<b>RQ</b>	\$ 1,118.00	\$ 1,150.00	\$ 564.00	\$ 1,684.00
			\$ 1,013.00	\$ 1,041.00	\$ 500.00	\$ 1,544.00
			\$ 1,138.00	\$ 1,175.00	\$ 579.00	\$ 1,684.00

Finish	Oval	Rectangular	PGE	PCY	DMY R/L Single	DMY R/L Pair	ML-F ENTRY
26	<b>EP</b>	<b>ER</b>	\$ 1,170.00	\$ 1,193.00	\$ 586.00	\$ 1,111.00	\$ 1,497.00
26D	<b>EP</b>	<b>ER</b>	\$ 1,229.00	\$ 1,240.00	\$ 609.00	\$ 1,158.00	\$ 1,532.00
			\$ 1,170.00	\$ 1,193.00	\$ 586.00	\$ 1,111.00	\$ 1,497.00
			\$ 1,229.00	\$ 1,240.00	\$ 609.00	\$ 1,158.00	\$ 1,532.00

The options listed above are considered standard.  
Non-standard options are available upon request.

For more options on **Rosettes and Escutcheon plates** see pages 16-17.

For more options on **Finishes** see pages 20-21.

**RE = Rectangular rosettes** available for tubular latch application only. Add + \$ 30.00 LIST to the price of the RQ

**Upcharges** apply for the following special options:

- Extra thick door (> 2")
- Non-standard rosettes (rosettes not listed above)
- Non-standard finishes (finishes not listed above)
- Split finishes

See page 15 for pricing. Exclusions may apply.

# H 359 Serie SOM New York Duemilasette

design Skidmore, Owings & Merrill



## GROUP II Matching elements

- Pg 112** Mortise lock functions
- Pg 130** Deadbolts
- Pg 136** Privacy Bolts
- Pg 142** Escutcheons with deadbolts
- Pg 148** Multi-Point Trim functions

Window lever available in the same design  
Call for pricing



### Sizes/Misure

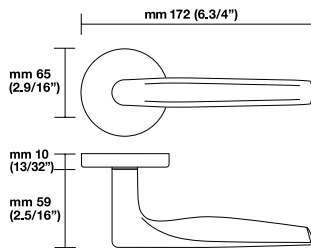

### Escutcheon options/Opzioni

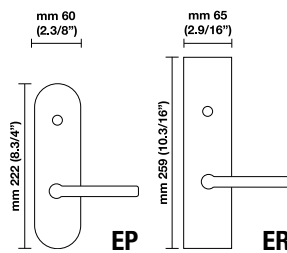

Conversions from metric to U.S. measurements are approximate.



See page 65  
for details

### Retail Price

Finish	Round	Square	PGE	PCY	DMY R/L Single	ML-F ENTRY
10S	RP	RQ	\$ 546.00	\$ 561.00	\$ 260.00	\$ 1,123.00
			\$ 656.00	\$ 671.00	\$ 315.00	\$ 1,286.00
14	RP	RQ	\$ 559.00	\$ 576.00	\$ 270.00	\$ 1,123.00
			\$ 669.00	\$ 686.00	\$ 325.00	\$ 1,286.00
15	RP	RQ	\$ 564.00	\$ 579.00	\$ 270.00	\$ 1,123.00
			\$ 674.00	\$ 689.00	\$ 325.00	\$ 1,286.00
26	RP	RQ	\$ 495.00	\$ 508.00	\$ 237.00	\$ 1,123.00
			\$ 605.00	\$ 618.00	\$ 292.00	\$ 1,286.00
26D	RP	RQ	\$ 520.00	\$ 535.00	\$ 249.00	\$ 1,123.00
			\$ 630.00	\$ 645.00	\$ 304.00	\$ 1,286.00

Finish	Oval	Rectangular	PGE	PCY	DMY R/L Single	DMY R/L Pair	ML-F ENTRY
26	EP	ER	\$ 762.00	\$ 772.00	\$ 375.00	\$ 702.00	\$ 1,076.00
			\$ 795.00	\$ 808.00	\$ 398.00	\$ 749.00	\$ 1,111.00
26D	EP	ER	\$ 762.00	\$ 772.00	\$ 375.00	\$ 702.00	\$ 1,076.00
			\$ 795.00	\$ 808.00	\$ 398.00	\$ 749.00	\$ 1,111.00

For more options on **Rosettes and Escutcheon plates** see pages 16-17.

For more options on **Finishes** see pages 20-21.

**RE = Rectangular rosettes** available for tubular latch application only. Add + \$ 30.00 LIST to the price of the RQ

**Upcharges** apply for the following special options:

- Extra thick door (> 2")
- Non-standard rosettes (rosettes not listed above)
- Non-standard finishes (finishes not listed above)
- Split finishes

See page 15 for pricing. Exclusions may apply.

The options listed above are considered standard.  
Non-standard options are available upon request.



# H 361 Serie AC4 Duemilasei



design Antonio Citterio with Toan Nguyen

Material: Nikrall Zamak Alloy UNI 3717

## GROUP I

### Matching elements

- Pg 112** Mortise lock functions
- Pg 130** Deadbolts
- Pg 136** Privacy Bolts
- Pg 142** Escutcheons with deadbolts
- Pg 148** Multi-Point Trim functions

Window lever available in the same design  
Call for pricing



### Sizes/Misure

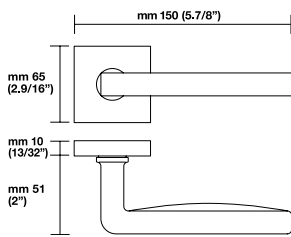

### Escutcheon options/Opzioni

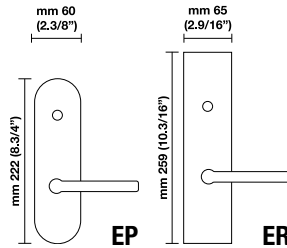

See page 18  
for details



See page 65  
for details

Conversions from metric to U.S. measurements are approximate.

### Retail Price

Finish	Round	Square	PGE	PCY	DMY R/L Single	ML-F ENTRY
14	RP	RQ	\$ 427.00	\$ 453.00	\$ 207.00	\$ 1,018.00
			\$ 564.00	\$ 581.00	\$ 285.00	\$ 1,146.00
15	RP	RQ	\$ 428.00	\$ 458.00	\$ 207.00	\$ 1,018.00
			\$ 552.00	\$ 569.00	\$ 280.00	\$ 1,146.00
16	RP	RQ	\$ 369.00	\$ 399.00	\$ 180.00	\$ 1,018.00
			\$ 496.00	\$ 511.00	\$ 251.00	\$ 1,146.00
26	RP	RQ	\$ 378.00	\$ 406.00	\$ 181.00	\$ 1,018.00
			\$ 498.00	\$ 513.00	\$ 247.00	\$ 1,146.00
26D	RP	RQ	\$ 390.00	\$ 422.00	\$ 191.00	\$ 1,018.00
			\$ 523.00	\$ 539.00	\$ 266.00	\$ 1,146.00

Finish	Oval	Rectangular	PGE	PCY	DMY R/L Single	DMY R/L Pair	ML-F ENTRY
26	EP	ER	\$ 632.00	\$ 644.00	\$ 305.00	\$ 562.00	\$ 960.00
			\$ 679.00	\$ 691.00	\$ 341.00	\$ 621.00	\$ 995.00
26D	EP	ER	\$ 632.00	\$ 644.00	\$ 305.00	\$ 562.00	\$ 960.00
			\$ 679.00	\$ 691.00	\$ 341.00	\$ 621.00	\$ 995.00

The options listed above are considered standard.  
Non-standard options are available upon request.

For more options on **Rosettes and Escutcheon plates** see pages 16-17.

For more options on **Finishes** see pages 20-21.

**RE = Rectangular rosettes** available for tubular latch application only. Add + \$ 30.00 LIST to the price of the RQ

**Upcharges** apply for the following special options:

- Extra thick door (> 2")
- Non-standard rosettes (rosettes not listed above)
- Non-standard finishes (finishes not listed above)
- Split finishes

See page 15 for pricing. Exclusions may apply.

# H 364 Serie MB Duemilanove

design Mario Bellini



## GROUP I Matching elements

- Pg 112** Mortise lock functions
- Pg 130** Deadbolts
- Pg 136** Privacy Bolts
- Pg 142** Escutcheons with deadbolts
- Pg 148** Multi-Point Trim functions

Window lever available in the same design  
Call for pricing



European version rosette

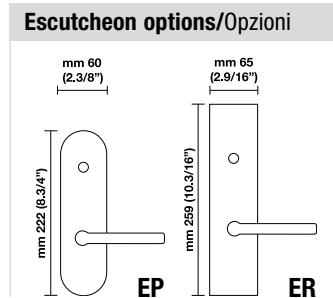
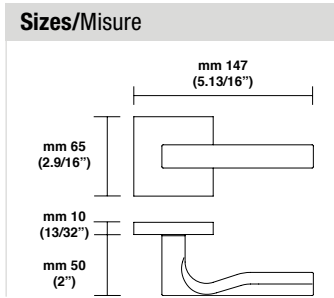

Conversions from metric to U.S. measurements are approximate.



See page 65  
for details

## Retail Price

Finish	Round	Square	PGE	PCY	DMY R/L Single	ML-F ENTRY
15	<b>RP</b>	<b>RQ</b>	\$ 495.00	\$ 528.00	\$ 239.00	\$ 1,018.00
			\$ 614.00	\$ 659.00	\$ 314.00	\$ 1,146.00
26	<b>RP</b>	<b>RQ</b>	\$ 460.00	\$ 483.00	\$ 218.00	\$ 1,018.00
			\$ 571.00	\$ 602.00	\$ 288.00	\$ 1,146.00
26D	<b>RP</b>	<b>RQ</b>	\$ 464.00	\$ 495.00	\$ 220.00	\$ 1,018.00
			\$ 588.00	\$ 618.00	\$ 301.00	\$ 1,146.00

Finish	Oval	Rectangular	PGE	PCY	DMY R/L Single	DMY R/L Pair	ML-F ENTRY
26	<b>EP</b>	<b>ER</b>	\$ 632.00	\$ 644.00	\$ 305.00	\$ 562.00	\$ 960.00
			\$ 679.00	\$ 691.00	\$ 341.00	\$ 621.00	\$ 995.00
26D	<b>EP</b>	<b>ER</b>	\$ 632.00	\$ 644.00	\$ 305.00	\$ 562.00	\$ 960.00
			\$ 679.00	\$ 691.00	\$ 341.00	\$ 621.00	\$ 995.00

For more options on **Rosettes and Escutcheon plates** see pages 16-17.

For more options on **Finishes** see pages 20-21.

**RE = Rectangular rosettes** available for tubular latch application only. Add + \$ 30.00 LIST to the price of the RQ

**Upcharges** apply for the following special options:

- Extra thick door (> 2")
- Non-standard rosettes (rosettes not listed above)
- Non-standard finishes (finishes not listed above)
- Split finishes

See page 15 for pricing. Exclusions may apply.

The options listed above are considered standard.  
Non-standard options are available upon request.

# H 367 Serie MB Duemilanove

design Giancarlo Vegni



## GROUP I Matching elements

- Pg 112** Mortise lock functions
- Pg 130** Deadbolts
- Pg 136** Privacy Bolts
- Pg 142** Escutcheons with deadbolts
- Pg 148** Multi-Point Trim functions

Window lever available in the same design  
Call for pricing



### Sizes/Misure

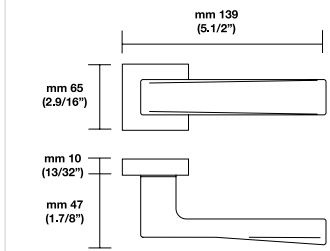

### Escutcheon options/Opzioni

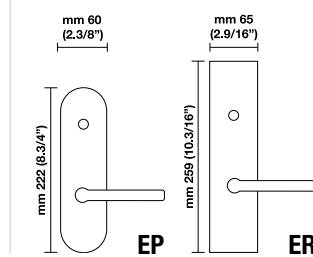

Conversions from metric to U.S. measurements are approximate.



See page 65  
for details

### Retail Price

Finish	Round	Square	PGE	PCY	DMY R/L Single	ML-F ENTRY
26	<b>RP</b>	<b>RQ</b>	\$ 464.00	\$ 487.00	\$ 220.00	\$ 1,018.00
26D	<b>RP</b>	<b>RQ</b>	\$ 471.00	\$ 495.00	\$ 222.00	\$ 1,018.00
			\$ 571.00	\$ 602.00	\$ 288.00	\$ 1,146.00
			\$ 588.00	\$ 618.00	\$ 301.00	\$ 1,146.00

Finish	Oval	Rectangular	PGE	PCY	DMY R/L Single	DMY R/L Pair	ML-F ENTRY
26	<b>EP</b>	<b>ER</b>	\$ 632.00	\$ 644.00	\$ 305.00	\$ 562.00	\$ 960.00
26D	<b>EP</b>	<b>ER</b>	\$ 632.00	\$ 644.00	\$ 305.00	\$ 562.00	\$ 960.00
			\$ 679.00	\$ 691.00	\$ 341.00	\$ 621.00	\$ 995.00
			\$ 679.00	\$ 691.00	\$ 341.00	\$ 621.00	\$ 995.00

The options listed above are considered standard.  
Non-standard options are available upon request.

For more options on **Rosettes and Escutcheon plates**  
see pages 16-17.

For more options on **Finishes** see pages 20-21.

**RE = Rectangular rosettes** available for tubular latch  
application only. Add + \$ 30.00 LIST to the price of the RQ

**Upcharges** apply for the following special options:

- Extra thick door (> 2")
- Non-standard rosettes (rosettes not listed above)
- Non-standard finishes (finishes not listed above)
- Split finishes

See page 15 for pricing. Exclusions may apply.

# H 368 Serie CA Duemilanove

design Studio Cerri & Associati



## GROUP I Matching elements

- Pg 112** Mortise lock functions
- Pg 130** Deadbolts
- Pg 136** Privacy Bolts
- Pg 142** Escutcheons with deadbolts
- Pg 148** Multi-Point Trim functions

Window lever available in the same design  
Call for pricing



### Sizes/Misure

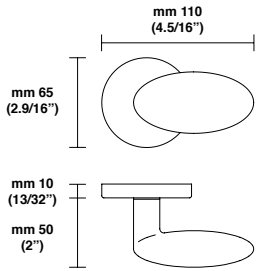

### Escutcheon options/Opzioni

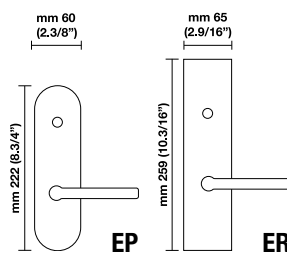

Conversions from metric to U.S. measurements are approximate.



See page 65  
for details

### Retail Price

Finish	Round	Square	PGE	PCY	DMY R/L Single	ML-F ENTRY
26	<b>RP</b>		\$ 425.00	\$ 448.00	\$ 200.00	\$ 1,018.00
		<b>RQ</b>	\$ 535.00	\$ 558.00	\$ 255.00	\$ 1,146.00
26D	<b>RP</b>		\$ 438.00	\$ 462.00	\$ 207.00	\$ 1,018.00
		<b>RQ</b>	\$ 548.00	\$ 572.00	\$ 262.00	\$ 1,146.00

Finish	Oval	Rectangular	PGE	PCY	DMY R/L Single	DMY R/L Pair	ML-F ENTRY
26	<b>EP</b>		\$ 632.00	\$ 644.00	\$ 305.00	\$ 562.00	\$ 960.00
		<b>ER</b>	\$ 679.00	\$ 691.00	\$ 341.00	\$ 621.00	\$ 995.00
26D	<b>EP</b>		\$ 632.00	\$ 644.00	\$ 305.00	\$ 562.00	\$ 960.00
		<b>ER</b>	\$ 679.00	\$ 691.00	\$ 341.00	\$ 621.00	\$ 995.00

The options listed above are considered standard.  
Non-standard options are available upon request.

For more options on **Rosettes and Escutcheon plates**  
see pages 16-17.  
For more options on **Finishes** see pages 20-21.

**RE = Rectangular rosettes** available for tubular latch  
application only. Add + \$ 30.00 LIST to the price of the RQ

**Upcharges** apply for the following special options:  
• Extra thick door (> 2")  
• Non-standard rosettes (rosettes not listed above)  
• Non-standard finishes (finishes not listed above)  
• Split finishes  
See page 15 for pricing. Exclusions may apply.

# H 369 Serie EG Duemilanove



design Eri Goshen

## GROUP II Matching elements

- Pg 112** Mortise lock functions
- Pg 130** Deadbolts
- Pg 136** Privacy Bolts
- Pg 142** Escutcheons with deadbolts
- Pg 148** Multi-Point Trim functions

Window lever available in the same design  
Call for pricing



### Sizes/Misure

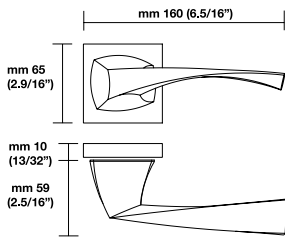

### Escutcheon options/Opzioni

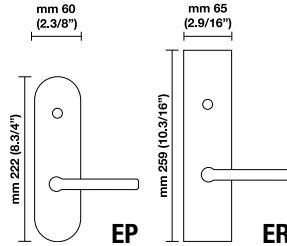

Conversions from metric to U.S. measurements are approximate.

### Retail Price

Finish	Round	Square	PGE	PCY	DMY R/L Single	ML-F ENTRY
26	<b>RP</b>		\$ 523.00	\$ 549.00	\$ 260.00	\$ 1,123.00
		<b>RQ</b>	\$ 671.00	\$ 696.00	\$ 347.00	\$ 1,286.00
26D	<b>RP</b>		\$ 543.00	\$ 569.00	\$ 270.00	\$ 1,123.00
		<b>RQ</b>	\$ 691.00	\$ 708.00	\$ 360.00	\$ 1,286.00

Finish	Oval	Rectangular	PGE	PCY	DMY R/L Single	DMY R/L Pair	ML-F ENTRY
26	<b>EP</b>		\$ 762.00	\$ 772.00	\$ 375.00	\$ 702.00	\$ 1,076.00
		<b>ER</b>	\$ 795.00	\$ 808.00	\$ 398.00	\$ 749.00	\$ 1,111.00
26D	<b>EP</b>		\$ 762.00	\$ 772.00	\$ 375.00	\$ 702.00	\$ 1,076.00
		<b>ER</b>	\$ 795.00	\$ 808.00	\$ 398.00	\$ 749.00	\$ 1,111.00

The options listed above are considered standard.  
Non-standard options are available upon request.

For more options on **Rosettes and Escutcheon plates** see pages 16-17.

For more options on **Finishes** see pages 20-21.

**RE = Rectangular rosettes** available for tubular latch application only. Add + \$ 30.00 LIST to the price of the RQ

**Upcharges** apply for the following special options:

- Extra thick door (> 2")
- Non-standard rosettes (rosettes not listed above)
- Non-standard finishes (finishes not listed above)
- Split finishes

See page 15 for pricing. Exclusions may apply.

# H 370 Serie MDF Duemiladieci

design Massimiliano & Doriana Fuksas



## GROUP I Matching elements

- Pg 112** Mortise lock functions
- Pg 130** Deadbolts
- Pg 136** Privacy Bolts
- Pg 142** Escutcheons with deadbolts
- Pg 148** Multi-Point Trim functions

Window lever available in the same design  
Call for pricing



European version rosette

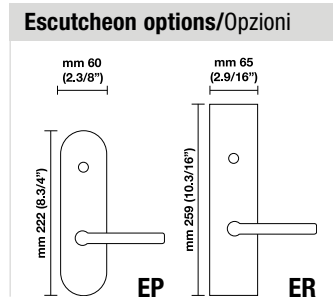
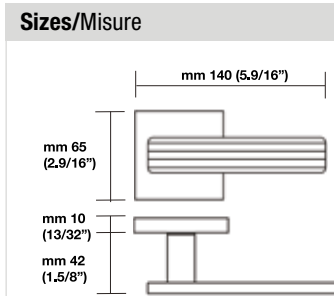

Conversions from metric to U.S. measurements are approximate.



See page 65  
for details

## Retail Price

Finish	Round	Square	PGE	PCY	DMY R/L Single	ML-F ENTRY
26	<b>RP</b>		\$ 360.00	\$ 386.00	\$ 179.00	\$ 1,018.00
		<b>RQ</b>	\$ 479.00	\$ 511.00	\$ 248.00	\$ 1,146.00
26D	<b>RP</b>		\$ 371.00	\$ 396.00	\$ 187.00	\$ 1,018.00
		<b>RQ</b>	\$ 496.00	\$ 530.00	\$ 266.00	\$ 1,146.00

Finish	Oval	Rectangular	PGE	PCY	DMY R/L Single	DMY R/L Pair	ML-F ENTRY
26	<b>EP</b>		\$ 632.00	\$ 644.00	\$ 305.00	\$ 562.00	\$ 960.00
		<b>ER</b>	\$ 679.00	\$ 691.00	\$ 341.00	\$ 621.00	\$ 995.00
26D	<b>EP</b>		\$ 632.00	\$ 644.00	\$ 305.00	\$ 562.00	\$ 960.00
		<b>ER</b>	\$ 679.00	\$ 691.00	\$ 341.00	\$ 621.00	\$ 995.00

For more options on **Rosettes and Escutcheon plates** see pages 16-17.  
For more options on **Finishes** see pages 20-21.

**RE = Rectangular rosettes** available for tubular latch application only. Add + \$ 30.00 LIST to the price of the RQ

**Upcharges** apply for the following special options:  
 • Extra thick door (> 2")  
 • Non-standard rosettes (rosettes not listed above)  
 • Non-standard finishes (finishes not listed above)  
 • Split finishes  
 See page 15 for pricing. Exclusions may apply.

The options listed above are considered standard.  
Non-standard options are available upon request.



# H 372 Serie EG Duemilaundici

design Eri Goshen

## GROUP I Matching elements

- Pg 112** Mortise lock functions
- Pg 130** Deadbolts
- Pg 136** Privacy Bolts
- Pg 142** Escutcheons with deadbolts
- Pg 148** Multi-Point Trim functions

Window lever available in the same design  
Call for pricing



### Sizes/Misure

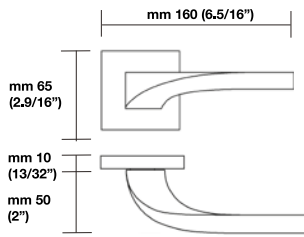

### Escutcheon options/Opzioni

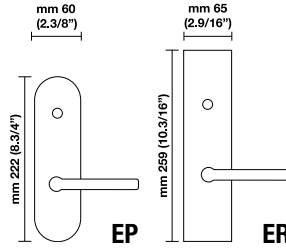

Conversions from metric to U.S. measurements are approximate.



See page 65  
for details

### Retail Price

Finish	Round	Square	PGE	PCY	DMY R/L Single	ML-F ENTRY
17A	RP	RQ	\$ 420.00	\$ 449.00	\$ 211.00	\$ 1,018.00
			\$ 557.00	\$ 592.00	\$ 297.00	\$ 1,146.00
26	RP	RQ	\$ 368.00	\$ 391.00	\$ 184.00	\$ 1,018.00
			\$ 479.00	\$ 511.00	\$ 251.00	\$ 1,146.00
26D	RP	RQ	\$ 383.00	\$ 410.00	\$ 193.00	\$ 1,018.00
			\$ 508.00	\$ 539.00	\$ 271.00	\$ 1,146.00

Finish	Oval	Rectangular	PGE	PCY	DMY R/L Single	DMY R/L Pair	ML-F ENTRY
26	EP	ER	\$ 632.00	\$ 644.00	\$ 305.00	\$ 562.00	\$ 960.00
			\$ 679.00	\$ 691.00	\$ 341.00	\$ 621.00	\$ 995.00
26D	EP	ER	\$ 632.00	\$ 644.00	\$ 305.00	\$ 562.00	\$ 960.00
			\$ 679.00	\$ 691.00	\$ 341.00	\$ 621.00	\$ 995.00

The options listed above are considered standard.  
Non-standard options are available upon request.

For more options on **Rosettes and Escutcheon plates**  
see pages 16-17.

For more options on **Finishes** see pages 20-21.

**RE = Rectangular rosettes** available for tubular latch  
application only. Add + \$ 30.00 LIST to the price of the RQ

**Upcharges** apply for the following special options:

- Extra thick door (> 2")
- Non-standard rosettes (rosettes not listed above)
- Non-standard finishes (finishes not listed above)
- Split finishes

See page 15 for pricing. Exclusions may apply.

# H 376 Serie GV Duemilaquattordici

design Giancarlo Vegni

## GROUP II Matching elements

- Pg 112** Mortise lock functions
- Pg 130** Deadbolts
- Pg 136** Privacy Bolts
- Pg 142** Escutcheons with deadbolts
- Pg 148** Multi-Point Trim functions

Window lever available in the same design  
Call for pricing



European version rosette

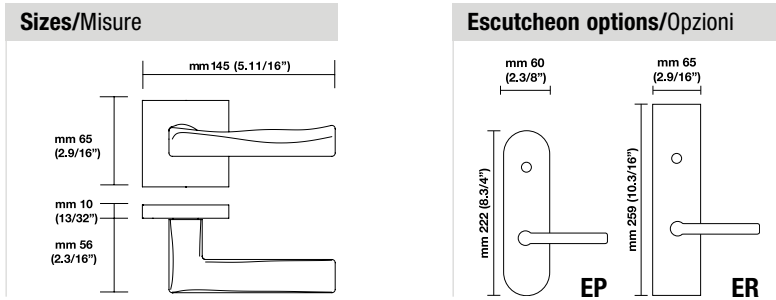

Conversions from metric to U.S. measurements are approximate.

### Retail Price

Finish	Round	Square	PGE	PCY	DMY R/L Single	ML-F ENTRY
26	<b>RP</b>		\$ 478.00	\$ 496.00	\$ 233.00	\$ 1,123.00
		<b>RQ</b>	\$ 582.00	\$ 618.00	\$ 298.00	\$ 1,286.00
26D	<b>RP</b>		\$ 490.00	\$ 513.00	\$ 246.00	\$ 1,123.00
		<b>RQ</b>	\$ 618.00	\$ 647.00	\$ 327.00	\$ 1,286.00

Finish	Oval	Rectangular	PGE	PCY	DMY R/L Single	DMY R/L Pair	ML-F ENTRY
26	<b>EP</b>		\$ 762.00	\$ 772.00	\$ 375.00	\$ 702.00	\$ 1,076.00
		<b>ER</b>	\$ 795.00	\$ 808.00	\$ 398.00	\$ 749.00	\$ 1,111.00
26D	<b>EP</b>		\$ 762.00	\$ 772.00	\$ 375.00	\$ 702.00	\$ 1,076.00
		<b>ER</b>	\$ 795.00	\$ 808.00	\$ 398.00	\$ 749.00	\$ 1,111.00

The options listed above are considered standard.  
Non-standard options are available upon request.

For more options on **Rosettes and Escutcheon plates** see pages 16-17.  
For more options on **Finishes** see pages 20-21.

**RE = Rectangular rosettes** available for tubular latch application only. Add + \$ 30.00 LIST to the price of the RQ

**Upcharges** apply for the following special options:

- Extra thick door (> 2")
- Non-standard rosettes (rosettes not listed above)
- Non-standard finishes (finishes not listed above)
- Split finishes

See page 15 for pricing. Exclusions may apply.

# H 377 Serie SL Duemilasedici



design Steve Leung

## GROUP III Matching elements

- Pg 112** Mortise lock functions
- Pg 130** Deadbolts
- Pg 136** Privacy Bolts
- Pg 142** Escutcheons with deadbolts
- Pg 148** Multi-Point Trim functions

Window lever available in the same design  
Call for pricing



European version rosette

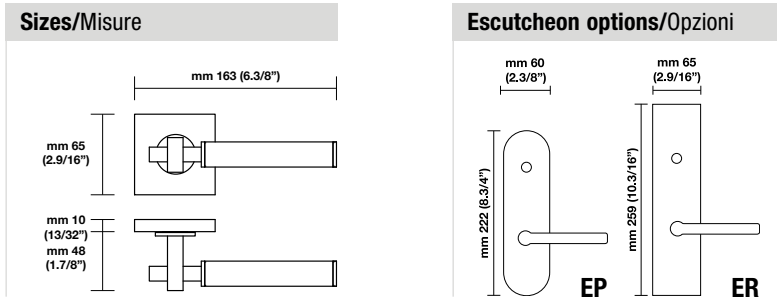

Conversions from metric to U.S. measurements are approximate.



See page 65  
for details

## Retail Price

Finish	Round	Square	PGE	PCY	DMY R/L Single	ML-F ENTRY
15	<b>RP</b>	<b>RQ</b>	\$ 599.00	\$ 627.00	\$ 293.00	\$ 1,497.00
			\$ 704.00	\$ 732.00	\$ 345.00	\$ 1,625.00
16	<b>RP</b>	<b>RQ</b>	\$ 501.00	\$ 527.00	\$ 246.00	\$ 1,497.00
			\$ 632.00	\$ 671.00	\$ 332.00	\$ 1,625.00
56	<b>RP</b>	<b>RQ</b>	\$ 699.00	\$ 751.00	\$ 354.00	\$ 1,497.00
			\$ 813.00	\$ 855.00	\$ 412.00	\$ 1,625.00

The options listed above are considered standard.  
Non-standard options are available upon request.

For more options on **Rosettes and Escutcheon plates**  
see pages 16-17.

For more options on **Finishes** see pages 20-21.

**RE = Rectangular rosettes** available for tubular latch  
application only. Add + \$ 30.00 LIST to the price of the RQ

**Upcharges** apply for the following special options:

- Extra thick door (> 2")
- Non-standard rosettes (rosettes not listed above)
- Non-standard finishes (finishes not listed above)
- Split finishes

See page 15 for pricing. Exclusions may apply.

# H 378 Serie YP Duemiladiciotto

design Yabu Pushelberg



## GROUP II Matching elements

- Pg 112** Mortise lock functions
- Pg 130** Deadbolts
- Pg 136** Privacy Bolts
- Pg 142** Escutcheons with deadbolts
- Pg 148** Multi-Point Trim functions

Window lever available in the same design  
Call for pricing

### Sizes/Misure

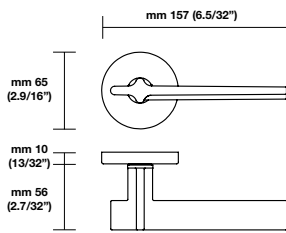

### Escutcheon options/Opzioni

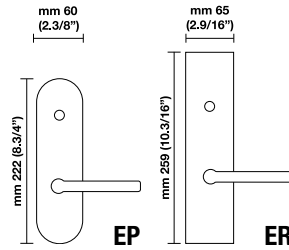

Conversions from metric to U.S. measurements are approximate.



See page 65  
for details

### Retail Price

Finish	Round	Square	PGE	PCY	DMY R/L Single	ML-F ENTRY
14	<b>RP</b>	<b>RQ</b>	\$ 535.00	\$ 561.00	\$ 258.00	\$ 1,123.00
17A	<b>RP</b>	<b>RQ</b>	\$ 588.00	\$ 618.00	\$ 283.00	\$ 1,123.00
26	<b>RP</b>	<b>RQ</b>	\$ 646.00	\$ 663.00	\$ 324.00	\$ 1,286.00
56	<b>RP</b>	<b>RQ</b>	\$ 643.00	\$ 675.00	\$ 309.00	\$ 1,123.00
			\$ 776.00	\$ 795.00	\$ 388.00	\$ 1,286.00

Finish	Oval	Rectangular	PGE	PCY	DMY R/L Single	DMY R/L Pair	ML-F ENTRY
26	<b>EP</b>	<b>ER</b>	\$ 762.00	\$ 772.00	\$ 375.00	\$ 702.00	\$ 1,076.00
			\$ 795.00	\$ 808.00	\$ 398.00	\$ 749.00	\$ 1,111.00

**NOTE:** Due to its particular design, this lever cannot be produced in any satin or matt finishes.

The options listed above are considered standard.  
Non-standard options are available upon request.

For more options on **Rosettes and Escutcheon plates**  
see pages 16-17.  
For more options on **Finishes** see pages 20-21.

**RE = Rectangular rosettes** available for tubular latch  
application only. Add + \$ 30.00 LIST to the price of the RQ

**Upcharges** apply for the following special options:  
• Extra thick door (> 2")  
• Non-standard rosettes (rosettes not listed above)  
• Non-standard finishes (finishes not listed above)  
• Split finishes  
See page 15 for pricing. Exclusions may apply.

# H 379 Serie AC Duemilaventi

design Antonio Citterio



## GROUP IV Matching elements

- Pg 112** Mortise lock functions
- Pg 130** Deadbolts
- Pg 136** Privacy Bolts
- Pg 142** Escutcheons with deadbolts
- Pg 148** Multi-Point Trim functions

Window lever available in the same design  
Call for pricing



The grip of the lever is knurled

### Sizes/Misure

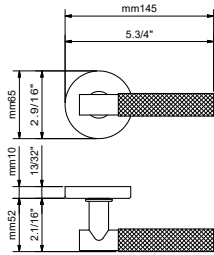

### Escutcheon options/Opzioni

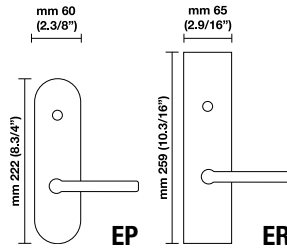

Conversions from metric to U.S. measurements are approximate.



See page 65  
for details

### Retail Price

Finish	Round	Square	PGE	PCY	DMY R/L Single	ML-F ENTRY
03M	RP	RQ	\$ 599.00	\$ 620.00	\$ 250.00	\$ 1,544.00
			\$ 699.00	\$ 730.00	\$ 299.00	\$ 1,684.00
06M	RP	RQ	\$ 702.00	\$ 717.00	\$ 250.00	\$ 1,544.00
			\$ 812.00	\$ 827.00	\$ 350.00	\$ 1,684.00
26D	RP	RQ	\$ 754.00	\$ 766.00	\$ 314.00	\$ 1,544.00
			\$ 864.00	\$ 876.00	\$ 369.00	\$ 1,684.00

Finish	Oval	Rectangular	PGE	PCY	DMY R/L Single	DMY R/L Pair	ML-F ENTRY
	EP	ER	\$ 1,100.00	\$ 1,146.00	\$ 539.00	\$ 1,030.00	\$ 1,497.00
26D			\$ 1,146.00	\$ 1,158.00	\$ 562.00	\$ 1,088.00	\$ 1,532.00

The options listed above are considered standard.  
Non-standard options are available upon request.

For more options on **Rosettes and Escutcheon plates**  
see pages 16-17.  
For more options on **Finishes** see pages 20-21.

**RE = Rectangular rosettes** available for tubular latch  
application only. Add + \$ 30.00 LIST to the price of the RQ

**Upcharges** apply for the following special options:  
• Extra thick door (> 2")  
• Non-standard rosettes (rosettes not listed above)  
• Non-standard finishes (finishes not listed above)  
• Split finishes  
See page 15 for pricing. Exclusions may apply.

# H 380 Serie AC1 Duemilaventi

design Antonio Citterio



## GROUP IV Matching elements

- Pg 112** Mortise lock functions
- Pg 130** Deadbolts
- Pg 136** Privacy Bolts
- Pg 142** Escutcheons with deadbolts
- Pg 148** Multi-Point Trim functions

Window lever available in the same design  
Call for pricing



The grip of the lever has an octagonal shape

### Sizes/Misure

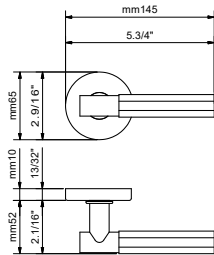

### Escutcheon options/Opzioni

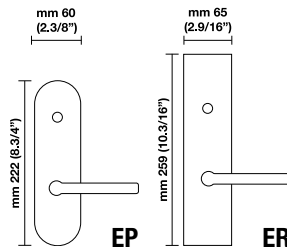

Conversions from metric to U.S. measurements are approximate.



See page 65  
for details

### Retail Price

Finish	Round	Square	PGE	PCY	DMY R/L Single	ML-F ENTRY
14	RP	RQ	\$ 702.00	\$ 717.00	\$ 295.00	\$ 1,544.00
26D	RP	RQ	\$ 702.00	\$ 717.00	\$ 295.00	\$ 1,544.00
56	RP	RQ	\$ 702.00	\$ 717.00	\$ 295.00	\$ 1,544.00
			\$ 812.00	\$ 827.00	\$ 350.00	\$ 1,684.00

Finish	Oval	Rectangular	PGE	PCY	DMY R/L Single	DMY R/L Pair	ML-F ENTRY
26D	EP	ER	\$ 1,100.00	\$ 1,146.00	\$ 539.00	\$ 1,030.00	\$ 1,497.00
			\$ 1,146.00	\$ 1,158.00	\$ 562.00	\$ 1,088.00	\$ 1,532.00

The options listed above are considered standard.  
Non-standard options are available upon request.

For more options on **Rosettes and Escutcheon plates**  
see pages 16-17.  
For more options on **Finishes** see pages 20-21.

**RE = Rectangular rosettes** available for tubular latch  
application only. Add + \$ 30.00 LIST to the price of the RQ

**Upcharges** apply for the following special options:  
• Extra thick door (> 2")  
• Non-standard rosettes (rosettes not listed above)  
• Non-standard finishes (finishes not listed above)  
• Split finishes  
See page 15 for pricing. Exclusions may apply.



# H 381 Serie KAN Duemilaventi

design Khalid Al Najjar



## GROUP I Matching elements

- Pg 112** Mortise lock functions
- Pg 130** Deadbolts
- Pg 136** Privacy Bolts
- Pg 142** Escutcheons with deadbolts
- Pg 148** Multi-Point Trim functions

Window lever available in the same design  
Call for pricing

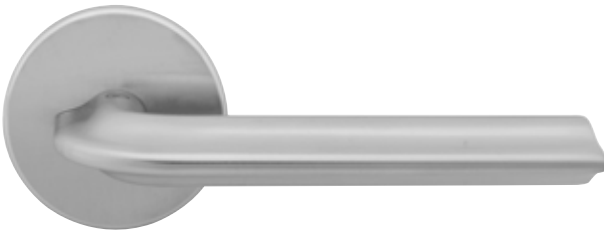

### Sizes/Misure

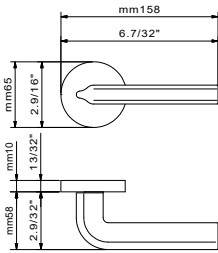

### Escutcheon options/Opzioni

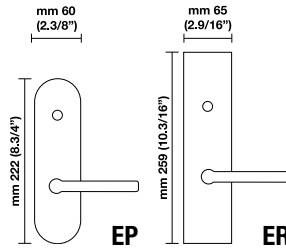

Conversions from metric to U.S. measurements are approximate.



See page 65  
for details

### Retail Price

Finish	Round	Square	PGE	PCY	DMY R/L Single	ML-F ENTRY
03M	RP	RQ	\$ 408.00	\$ 681.00 <sup>1</sup>	\$ 195.00	\$ 1,018.00
			\$ 518.00	\$ 791.00 <sup>1</sup>	\$ 250.00	\$ 1,146.00
15	RP	RQ	\$ 499.00	\$ 770.00 <sup>1</sup>	\$ 244.00	\$ 1,018.00
			\$ 616.00	\$ 880.00 <sup>1</sup>	\$ 299.00	\$ 1,146.00
17A	RP	RQ	\$ 499.00	\$ 770.00 <sup>1</sup>	\$ 244.00	\$ 1,018.00
			\$ 616.00	\$ 880.00 <sup>1</sup>	\$ 299.00	\$ 1,146.00
26D	RP	RQ	\$ 499.00	\$ 770.00 <sup>1</sup>	\$ 244.00	\$ 1,018.00
			\$ 616.00	\$ 880.00 <sup>1</sup>	\$ 299.00	\$ 1,146.00

<sup>1</sup> It does not fit a privacy pin, supplied with 105 Privacy Bolt

Finish	Oval	Rectangular	PGE	PCY	DMY R/L Single	DMY R/L Pair	ML-F ENTRY
	EP	ER	\$ 632.00	\$ 644.00	\$ 305.00	\$ 562.00	\$ 960.00
26D			\$ 679.00	\$ 691.00	\$ 341.00	\$ 621.00	\$ 995.00

The options listed above are considered standard.  
Non-standard options are available upon request.

For more options on **Rosettes and Escutcheon plates**  
see pages 16-17.

For more options on **Finishes** see pages 20-21.

**RE = Rectangular rosettes** available for tubular latch  
application only. Add + \$ 30.00 LIST to the price of the RQ

**Upcharges** apply for the following special options:

- Extra thick door (> 2")
- Non-standard rosettes (rosettes not listed above)
- Non-standard finishes (finishes not listed above)
- Split finishes

See page 15 for pricing. Exclusions may apply.

# H 382 Serie CCD Duemilaventi

design Joe Cheng



## GROUP I Matching elements

- Pg 112** Mortise lock functions
- Pg 130** Deadbolts
- Pg 136** Privacy Bolts
- Pg 142** Escutcheons with deadbolts
- Pg 148** Multi-Point Trim functions

Window lever available in the same design  
Call for pricing



### Sizes/Misure

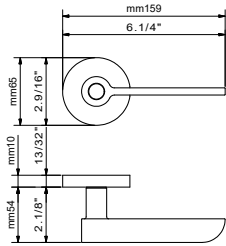

### Escutcheon options/Opzioni

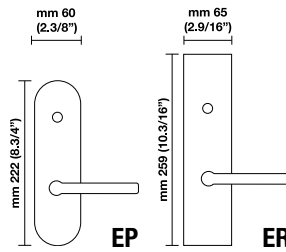

Conversions from metric to U.S. measurements are approximate.



See page 65  
for details

### Retail Price

Finish	Round	Square	PGE	PCY	DMY R/L Single	ML-F ENTRY
03D	RP	RQ	\$ 408.00	\$ 431.00	\$ 195.00	\$ 1,018.00
06B	RP	RQ	\$ 518.00	\$ 541.00	\$ 250.00	\$ 1,146.00
14	RP	RQ	\$ 408.00	\$ 431.00	\$ 195.00	\$ 1,018.00
26	RP	RQ	\$ 518.00	\$ 541.00	\$ 250.00	\$ 1,146.00
			\$ 499.00	\$ 520.00	\$ 244.00	\$ 1,018.00
			\$ 616.00	\$ 630.00	\$ 299.00	\$ 1,146.00
			\$ 499.00	\$ 520.00	\$ 244.00	\$ 1,018.00
			\$ 616.00	\$ 630.00	\$ 299.00	\$ 1,146.00

Finish	Oval	Rectangular	PGE	PCY	DMY R/L Single	DMY R/L Pair	ML-F ENTRY
26	EP	ER	\$ 632.00	\$ 644.00	\$ 305.00	\$ 562.00	\$ 960.00
			\$ 679.00	\$ 691.00	\$ 341.00	\$ 621.00	\$ 995.00

For more options on **Rosettes and Escutcheon plates** see pages 16-17.

For more options on **Finishes** see pages 20-21.

**RE = Rectangular rosettes** available for tubular latch application only. Add + \$ 30.00 LIST to the price of the RQ

**Upcharges** apply for the following special options:

- Extra thick door (> 2")
- Non-standard rosettes (rosettes not listed above)
- Non-standard finishes (finishes not listed above)
- Split finishes

See page 15 for pricing. Exclusions may apply.

The options listed above are considered standard.  
Non-standard options are available upon request.

# H 383 Serie PW Duemilaventuno

design Perkins&Will



## GROUP I Matching elements

- Pg 112** Mortise lock functions
- Pg 130** Deadbolts
- Pg 136** Privacy Bolts
- Pg 142** Escutcheons with deadbolts
- Pg 148** Multi-Point Trim functions

Window lever available in the same design  
Call for pricing



### Sizes/Misure

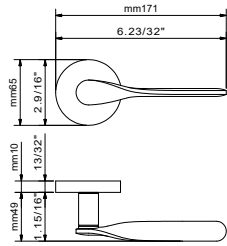

### Escutcheon options/Opzioni

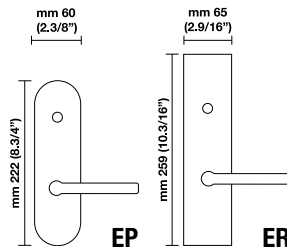

Conversions from metric to U.S. measurements are approximate.



See page 65  
for details

### Retail Price

Finish	Round	Square	PGE	PCY	DMY R/L Single	ML-F ENTRY
15	RP	RQ	\$ 499.00	\$ 520.00	\$ 244.00	\$ 1,018.00
			\$ 616.00	\$ 630.00	\$ 299.00	\$ 1,146.00
16	RP	RQ	\$ 408.00	\$ 431.00	\$ 195.00	\$ 1,018.00
			\$ 518.00	\$ 541.00	\$ 250.00	\$ 1,146.00
26D	RP	RQ	\$ 499.00	\$ 520.00	\$ 244.00	\$ 1,018.00
			\$ 616.00	\$ 630.00	\$ 299.00	\$ 1,146.00
56	RP	RQ	\$ 499.00	\$ 520.00	\$ 244.00	\$ 1,018.00
			\$ 616.00	\$ 630.00	\$ 299.00	\$ 1,146.00

Finish	Oval	Rectangular	PGE	PCY	DMY R/L Single	DMY R/L Pair	ML-F ENTRY
26D	EP	ER	\$ 632.00	\$ 644.00	\$ 305.00	\$ 562.00	\$ 960.00
			\$ 679.00	\$ 691.00	\$ 341.00	\$ 621.00	\$ 995.00

The options listed above are considered standard.  
Non-standard options are available upon request.

For more options on **Rosettes and Escutcheon plates** see pages 16-17.

For more options on **Finishes** see pages 20-21.

**RE = Rectangular rosettes** available for tubular latch application only. Add + \$ 30.00 LIST to the price of the RQ

**Upcharges** apply for the following special options:

- Extra thick door (> 2")
- Non-standard rosettes (rosettes not listed above)
- Non-standard finishes (finishes not listed above)
- Split finishes

See page 15 for pricing. Exclusions may apply.

# H 384 Serie CR Duemilaventuno



design CetraRuddy

## GROUP II Matching elements

- Pg 112** Mortise lock functions
- Pg 130** Deadbolts
- Pg 136** Privacy Bolts
- Pg 142** Escutcheons with deadbolts
- Pg 148** Multi-Point Trim functions

Window lever available in the same design  
Call for pricing

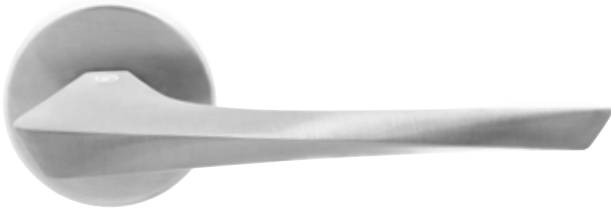

### Sizes/Misure

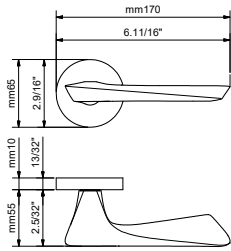

### Escutcheon options/Opzioni

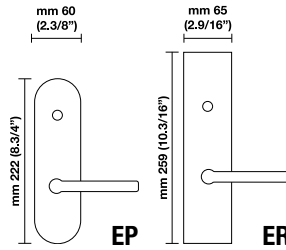

Conversions from metric to U.S. measurements are approximate.



See page 65  
for details

### Retail Price

Finish	Round	Square	PGE	PCY	DMY R/L Single	ML-F ENTRY
15	RP	RQ	\$ 564.00	\$ 579.00	\$ 270.00	\$ 1,123.00
			\$ 674.00	\$ 689.00	\$ 325.00	\$ 1,286.00
17A	RP	RQ	\$ 584.00	\$ 599.00	\$ 285.00	\$ 1,123.00
			\$ 694.00	\$ 699.00	\$ 335.00	\$ 1,286.00
26	RP	RQ	\$ 520.00	\$ 535.00	\$ 249.00	\$ 1,123.00
			\$ 630.00	\$ 645.00	\$ 299.00	\$ 1,286.00
26D	RP	RQ	\$ 559.00	\$ 576.00	\$ 270.00	\$ 1,123.00
			\$ 669.00	\$ 686.00	\$ 325.00	\$ 1,286.00
56	RP	RQ	\$ 564.00	\$ 579.00	\$ 270.00	\$ 1,123.00
			\$ 674.00	\$ 689.00	\$ 325.00	\$ 1,286.00

Finish	Oval	Rectangular	PGE	PCY	DMY R/L Single	DMY R/L Pair	ML-F ENTRY
26	EP	ER	\$ 762.00	\$ 772.00	\$ 375.00	\$ 702.00	\$ 1,076.00
			\$ 795.00	\$ 808.00	\$ 375.00	\$ 749.00	\$ 1,111.00
26D	EP	ER	\$ 762.00	\$ 772.00	\$ 375.00	\$ 702.00	\$ 1,076.00
			\$ 795.00	\$ 808.00	\$ 375.00	\$ 749.00	\$ 1,111.00

For more options on **Rosettes and Escutcheon plates** see pages 16-17.

For more options on **Finishes** see pages 20-21.

**RE = Rectangular rosettes** available for tubular latch application only. Add + \$ 30.00 LIST to the price of the RQ

**Upcharges** apply for the following special options:

- Extra thick door (> 2")
- Non-standard rosettes (rosettes not listed above)
- Non-standard finishes (finishes not listed above)
- Split finishes

See page 15 for pricing. Exclusions may apply.

The options listed above are considered standard.  
Non-standard options are available upon request.



# door knobs

# K 377 Serie SL Duemilasedici

design Steve Leung

## GROUP III Matching elements

- Pg 112** Mortise lock functions
- Pg 130** Deadbolts
- Pg 136** Privacy Bolts
- Pg 142** Escutcheons with deadbolts



### Sizes/Misure

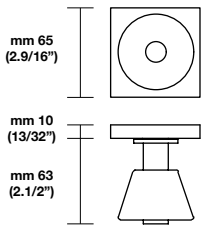

### Escutcheon options/Opzioni

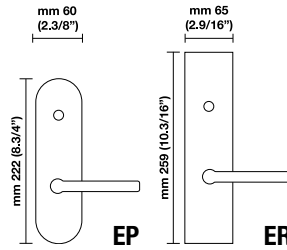

Conversions from metric to U.S. measurements are approximate.



See page 65  
for details

### Retail Price

Finish	Round	Square	PGE	PCY	DMY R/L Single	ML-F ENTRY
15	<b>RP</b>	<b>RQ</b>	\$ 474.00	\$ 487.00	\$ 230.00	\$ 1,497.00
			\$ 595.00	\$ 609.00	\$ 287.00	\$ 1,625.00
16	<b>RP</b>	<b>RQ</b>	\$ 397.00	\$ 407.00	\$ 194.00	\$ 1,497.00
			\$ 499.00	\$ 511.00	\$ 241.00	\$ 1,625.00
56	<b>RP</b>	<b>RQ</b>	\$ 481.00	\$ 506.00	\$ 234.00	\$ 1,497.00
			\$ 829.00	\$ 839.00	\$ 409.00	\$ 1,625.00

The options listed above are considered standard. Non-standard options are available upon request.

For more options on **Rosettes and Escutcheon plates** see pages 16-17.

For more options on **Finishes** see pages 20-21.

**RE = Rectangular rosettes** available for tubular latch application only. Add + \$ 30.00 LIST to the price of the RQ

**Upcharges** apply for the following special options:

- Extra thick door (> 2")
- Non-standard rosettes (rosettes not listed above)
- Non-standard finishes (finishes not listed above)
- Split finishes

See page 15 for pricing. Exclusions may apply.



# K 378 Serie YP Duemiladiciotto

design Yabu Pushelberg



## GROUP II Matching elements

- Pg 112** Mortise lock functions
- Pg 130** Deadbolts
- Pg 136** Privacy Bolts
- Pg 142** Escutcheons with deadbolts



### Sizes/Misure

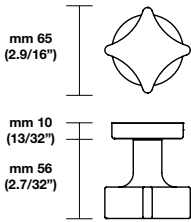

### Escutcheon options/Opzioni

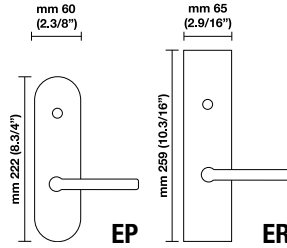





Conversions from metric to U.S. measurements are approximate.



See page 65  
for details

### Retail Price

Finish	Round	Square	PGE	PCY	DMY R/L Single	ML-F ENTRY
						
14	<b>RP</b>	<b>RQ</b>	\$ 417.00	\$ 429.00	\$ 250.00	\$ 1,123.00
17A	<b>RP</b>	<b>RQ</b>	\$ 481.00	\$ 504.00	\$ 233.00	\$ 1,123.00
26	<b>RP</b>	<b>RQ</b>	\$ 523.00	\$ 536.00	\$ 252.00	\$ 1,286.00
56	<b>RP</b>	<b>RQ</b>	\$ 481.00	\$ 504.00	\$ 233.00	\$ 1,123.00
			\$ 797.00	\$ 807.00	\$ 396.00	\$ 1,286.00

Finish	Oval	Rectangular	PGE	PCY	DMY R/L Single	DMY R/L Pair	ML-F ENTRY
							
26	<b>EP</b>	<b>ER</b>	\$ 762.00	\$ 772.00	\$ 375.00	\$ 702.00	\$ 1,076.00
			\$ 795.00	\$ 808.00	\$ 375.00	\$ 749.00	\$ 1,111.00

The options listed above are considered standard. Non-standard options are available upon request.

For more options on **Rosettes and Escutcheon plates** see pages 16-17.  
For more options on **Finishes** see pages 20-21.

**RE = Rectangular rosettes** available for tubular latch application only. Add + \$ 30.00 LIST to the price of the RQ

**Upcharges** apply for the following special options:

- Extra thick door (> 2")
- Non-standard rosettes (rosettes not listed above)
- Non-standard finishes (finishes not listed above)
- Split finishes

See page 15 for pricing. Exclusions may apply.

# K 383 Serie PW Duemilaventuno



design Perkins&Will

## GROUP II Matching elements

- Pg 112** Mortise lock functions
- Pg 130** Deadbolts
- Pg 136** Privacy Bolts
- Pg 142** Escutcheons with deadbolts



### Sizes/Misure

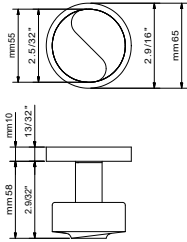

### Escutcheon options/Opzioni

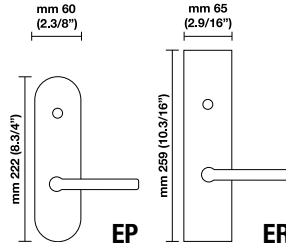

Conversions from metric to U.S. measurements are approximate.



See page 65  
for details

### Retail Price

Finish	Round	Square	PGE	PCY	DMY R/L Single	ML-F ENTRY
15	RP	RQ	\$ 576.00	\$ 632.00	\$ 296.00	\$ 1,123.00
			\$ 698.00	\$ 724.00	\$ 357.00	\$ 1,286.00
16	RP	RQ	\$ 490.00	\$ 530.00	\$ 239.00	\$ 1,123.00
			\$ 610.00	\$ 650.00	\$ 299.00	\$ 1,286.00
26D	RP	RQ	\$ 550.00	\$ 579.00	\$ 271.00	\$ 1,123.00
			\$ 679.00	\$ 710.00	\$ 345.00	\$ 1,286.00
56	RP	RQ	\$ 599.00	\$ 650.00	\$ 310.00	\$ 1,123.00
			\$ 719.00	\$ 770.00	\$ 430.00	\$ 1,286.00

Finish	Oval	Rectangular	PGE	PCY	DMY R/L Single	DMY R/L Pair	ML-F ENTRY
26D	EP	ER	\$ 762.00	\$ 772.00	\$ 375.00	\$ 702.00	\$ 1,076.00
			\$ 795.00	\$ 808.00	\$ 398.00	\$ 749.00	\$ 1,111.00

The options listed above are considered standard.  
Non-standard options are available upon request.

For more options on **Rosettes and Escutcheon plates** see pages 16-17.

For more options on **Finishes** see pages 20-21.

**RE = Rectangular rosettes** available for tubular latch application only. Add + \$ 30.00 LIST to the price of the RQ

**Upcharges** apply for the following special options:

- Extra thick door (> 2")
- Non-standard rosettes (rosettes not listed above)
- Non-standard finishes (finishes not listed above)
- Split finishes

See page 15 for pricing. Exclusions may apply.





european  
version and  
slim rosette  
options

# European version levers (Trim only)



(Shown with H 361 R8Y)

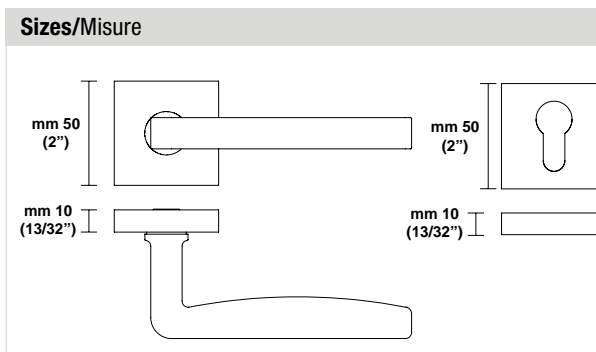

Conversions from metric to U.S. measurements are approximate.

## GROUP I

H315, H317, H326, H327, H330, H334, H338, H348, H361, H364, H367, H368, H370, H372, H381, H382, H383

### Retail Price

	RP	RQ
R8Y (PGE)	\$ 421.00	\$ 536.00
R8 BZG (PCY with PCY Thumbturn)	\$ 744.00	\$ 860.00

## GROUP II

H311, H329, H335, H343, H359, H369, H376, H378, H384, K378, K383

### Retail Price

	RP	RQ
R8Y (PGE)	\$ 537.00	\$ 653.00
R8 BZG (PCY with PCY Thumbturn)	\$ 873.00	\$ 988.00

## GROUP III

H350, H377, K377

### Retail Price

	RP	RQ
R8Y (PGE)	\$ 855.00	\$ 970.00
R8 BZG (PCY with PCY Thumbturn)	\$ 1,200.00	\$ 1,335.00

## GROUP IV

H354, H356, H379, H380

### Retail Price

	RP	RQ
R8Y (PGE)	\$ 912.00	\$ 999.00
R8 BZG (PCY with PCY Thumbturn)	\$ 1,289.00	\$ 1,400.00

## GROUP INOX

H5008, H5014, H5015, H5015 with leather, H5017, K5301, K5302

### Retail Price

	RP	RQ
R8Y (PGE)	\$ 912.00	\$ 999.00
R6 BZG (PCY with PCY Thumbturn)	\$ 1,289.00	\$ 1,400.00

The configuration above is only suitable for European mortise locks. The lock is not included in the prices. European mortise locks (mechanical and magnetic) can be purchased separately. Call for pricing.

The prices above are for the standard finishes of each lever listed. See corresponding catalog pages. Different finishes are available upon special request. See page 20 for more finish options and page 15 for pricing.

The privacy sets are supplied with the European privacy thumbturn: K1704 R678 50 BZG (round) or K1225 R678 50 BZG (square)

# Slim rosette option



(Shown with H 378 RSB and K382 RSB)

Conversions from metric to U.S. measurements are approximate.

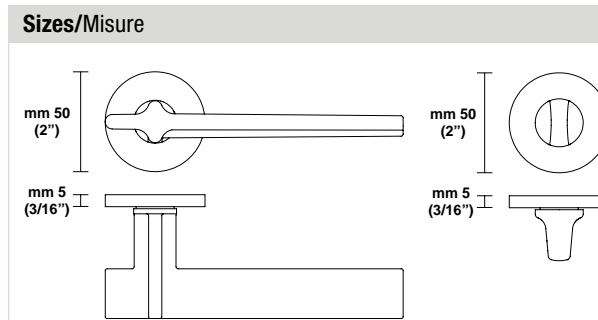

Valli&Valli offers special slim rosettes = **3/16" (5mm)** exclusively for the models below.  
To order, select a lever/knob and use the code RSB (round) or RSBQ (square). For privacy bolt only price see page 139.

**GROUP I** H315, H317, H326, H327, H330, H338, H348, H361, H364, H367, H368, H370, H372, H381, H382, H383

**Retail Price**

	<b>RSB</b>	<b>RSBQ</b>
PGE	\$ 463.00	\$ 579.00
PCY with PCY Bolt	\$ 834.00	\$ 950.00
Dummy RH or LH	\$ 220.00	\$ 278.00

**GROUP II** H311, H329, H343, H359, H378, H384, K378, K383

**Retail Price**

	<b>RSB</b>	<b>RSBQ</b>
PGE	\$ 580.00	\$ 695.00
PCY with PCY Bolt	\$ 962.00	\$ 1,077.00
Dummy RH or LH	\$ 278.00	\$ 336.00

**GROUP III** H377, K377

**Retail Price**

	<b>RSB</b>	<b>RSBQ</b>
PGE	\$ 938.00	\$ 1,054.00
PCY with PCY Bolt	\$ 1,308.00	\$ 1,424.00
Dummy RH or LH	\$ 453.00	\$ 510.00

**GROUP IV** H356, H379, H380

**Retail Price**

	<b>RSB</b>	<b>RSBQ</b>
PGE	\$ 996.00	\$ 1,112.00
PCY with PCY Bolt	\$ 1,378.00	\$ 1,494.00
Dummy RH or LH	\$ 487.00	\$ 544.00

The configuration above is only available for tubular application.  
For mortise application – call for details and pricing.

Finishes available are 14, 15, 26 and 26D.

Different finishes are available upon special request.  
See page 20 for more options and page 15 for pricing.

The privacy sets are supplied with privacy bolt on slim rosette  
(round or square).





door pulls

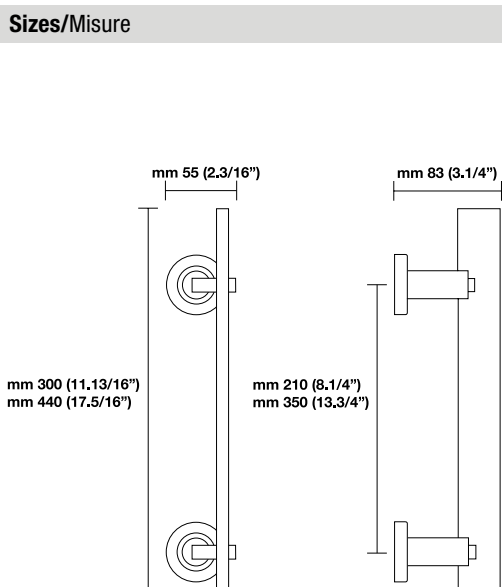

Conversions from metric to U.S. measurements are approximate.

## K 352 RH/LH

Finish	Size	Dimension	Center to center	Retail price
	210	mm 300x55x83 [11.13/16"x2.3/16"x3.1/4"]	mm 210 [8.1/4"]	\$ 533.00
26	350	mm 440x55x83 [17.5/16"x2.3/16"x3.1/4"]	mm 350 [13.3/4"]	\$ 628.00

**Note:** Complete with fixing systems for single and back to back mounting on wood (X0526, X0523) and glass doors (X0525, X0523).

When ordering the K352 specify the below:

RH = Pull grip on the right side

LH = Pull grip on the left side

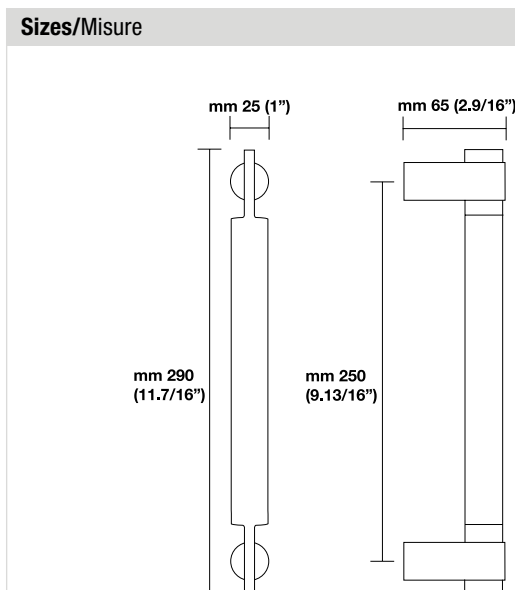

Conversions from metric to U.S. measurements are approximate.

### K 353 SINGLE

Finish	Size	Dimension	Center to center	Retail price
26/26D*	250	mm 290x25x65 [11.7/16"x1"x2.9/16"]	mm 250 [9.13/16"]	\$ 501.00

### K 353/K 353 S - BACK TO BACK

Finish	Size	Dimension	Center to center	Retail price
26/26D*	250	mm 290x25x65 [11.7/16"x1"x2.9/16"]	mm 250 [9.13/16"]	\$ 1,064.00

\* The grip part is satin, the stand-off posts are polished

**Note:** Complete with fixing systems for single and back to back mounting on wood (X0510, X0509) and glass doors (X0508, X0510).

# K 356 Serie JP Duemila

design John Pawson

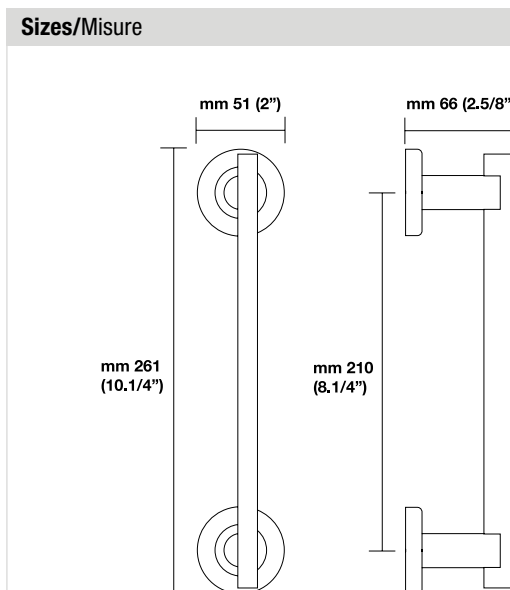

Conversions from metric to U.S. measurements are approximate.

## K 356 SINGLE

Finish	Size	Dimension	Center to center	Retail price
26	210	mm 261x51x66 [10.1/4"x2"x2.5/8"]	mm 210 [8.1/4"]	\$ 556.00
26D	210	mm 261x51x66 [10.1/4"x2"x2.5/8"]	mm 210 [8.1/4"]	\$ 538.00

**Note:** Complete with fixing systems for single and back to back mounting on wood (X0526, X0523) and glass doors (X0525, X0523).

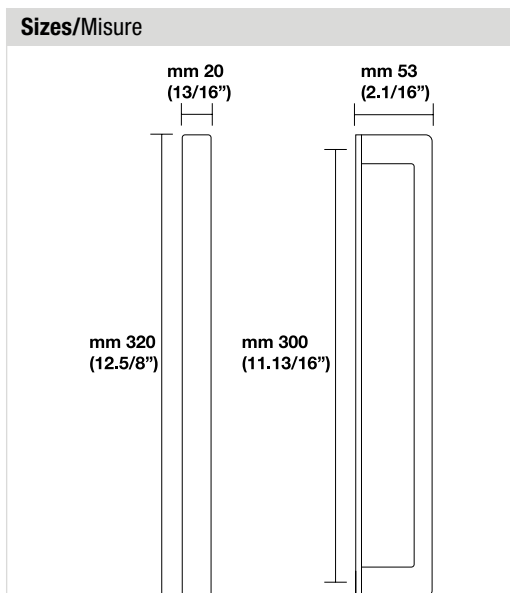

Conversions from metric to U.S. measurements are approximate.

### K 358 SINGLE

Finish	Size	Dimension	Center to center	Retail price
26	300	mm 320x20x53 [12.5/8"x13/16"x2.1/16"]	mm 300 [11.13/16"]	\$ 555.00
26D	300	mm 320x20x53 [12.5/8"x13/16"x2.1/16"]	mm 300 [11.13/16"]	\$ 583.00

### K 358/K 358 S - BACK TO BACK

Finish	Size	Dimension	Center to center	Retail price
26	300	mm 320x20x53 [12.5/8"x13/16"x2.1/16"]	mm 300 [11.13/16"]	\$ 1,153.00
26D	300	mm 320x20x53 [12.5/8"x13/16"x2.1/16"]	mm 300 [11.13/16"]	\$ 1,209.00

**Note:** Complete with fixing systems for single and back to back mounting on wood (X0526, X0523) and glass doors (X0525, X0523).

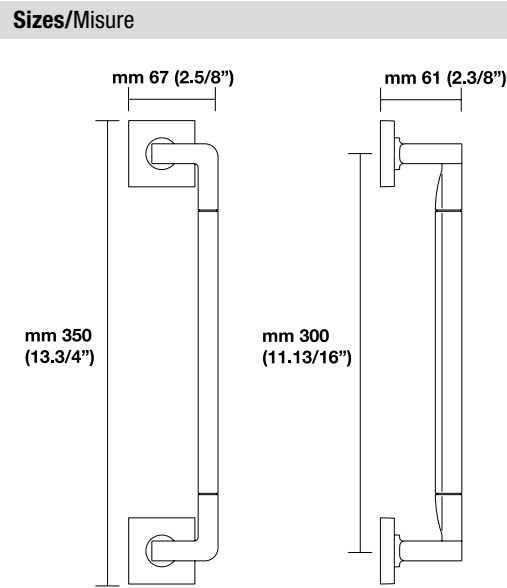

Conversions from metric to U.S. measurements are approximate.

### K 368 SINGLE

Finish	Size	Dimension	Center to center	Retail price
26	300	mm 350x67x61 [13.3/4"x2.5/8"x2.3/8"]	mm 300 [11.13/16"]	\$ 648.00
26D	300	mm 350x67x61 [13.3/4"x2.5/8"x2.3/8"]	mm 300 [11.13/16"]	\$ 682.00

### K 368/K 368 S - BACK TO BACK

Finish	Size	Dimension	Center to center	Retail price
26	300	mm 350x67x61 [13.3/4"x2.5/8"x2.3/8"]	mm 300 [11.13/16"]	\$ 1,340.00
26D	300	mm 350x67x61 [13.3/4"x2.5/8"x2.3/8"]	mm 300 [11.13/16"]	\$ 1,406.00

**Note:** Complete with fixing systems for single and back to back mounting on wood (X0526, X0523) and glass doors (X0525, X0523).



design Steve Leung

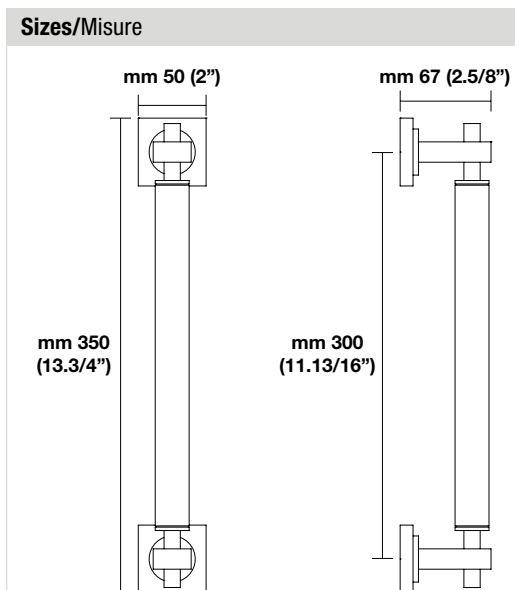

Conversions from metric to U.S. measurements are approximate.

### K 377 SINGLE

Finish	Size	Dimension	Center to center	Retail price
15	300	mm 350x50x67 [13.3/4"x1.15/16"x2.5/8"]	mm 300 [11.13/16"]	\$ 416.00
16	300	mm 350x50x67 [13.3/4"x1.15/16"x2.5/8"]	mm 300 [11.13/16"]	\$ 360.00
56	300	mm 350x50x67 [13.3/4"x1.15/16"x2.5/8"]	mm 300 [11.13/16"]	\$ 450.00

### K 377/K 377 S - BACK TO BACK

Finish	Size	Dimension	Center to center	Retail price
15	300	mm 350x50x67 [13.3/4"x1.15/16"x2.5/8"]	mm 300 [11.13/16"]	\$ 840.00
16	300	mm 350x50x67 [13.3/4"x1.15/16"x2.5/8"]	mm 300 [11.13/16"]	\$ 762.00
56	300	mm 350x50x67 [13.3/4"x1.15/16"x2.5/8"]	mm 300 [11.13/16"]	\$ 940.00

**Note:** Complete with fixing systems for single and back to back mounting on wood (X0526, X0523) and glass doors (X0525, X0523).

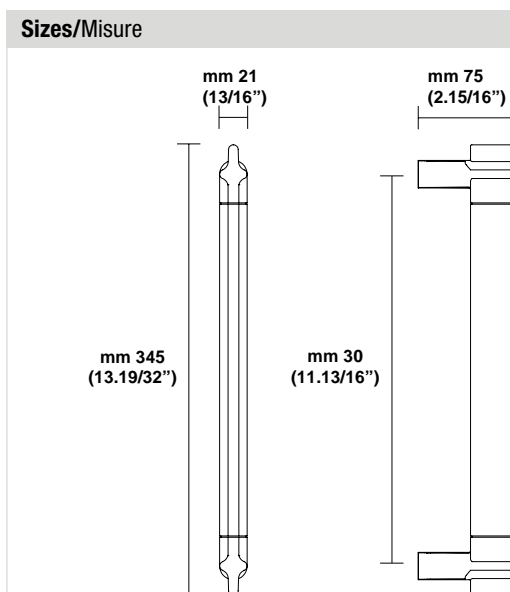

Conversions from metric to U.S. measurements are approximate.

## K 378 SINGLE

Finish	Size	Dimension	Center to center	Retail price
14	300	mm 345x21x75 [13.19/32"x13/16"x2.15/16"]	mm 300 [11.13/16"]	\$ 650.00
17A	300	mm 345x21x75 [13.19/32"x13/16"x2.15/16"]	mm 300 [11.13/16"]	\$ 715.00
26	300	mm 345x21x75 [13.19/32"x13/16"x2.15/16"]	mm 300 [11.13/16"]	\$ 650.00
56	300	mm 345x21x75 [13.19/32"x13/16"x2.15/16"]	mm 300 [11.13/16"]	\$ 780.00

## K 378/K 378 S - BACK TO BACK

Finish	Size	Dimension	Center to center	Retail price
14	300	mm 345x21x75 [13.19/32"x13/16"x2.15/16"]	mm 300 [11.13/16"]	\$ 1,346.00
17A	300	mm 345x21x75 [13.19/32"x13/16"x2.15/16"]	mm 300 [11.13/16"]	\$ 1,481.00
26	300	mm 345x21x75 [13.19/32"x13/16"x2.15/16"]	mm 300 [11.13/16"]	\$ 1,346.00
56	300	mm 345x21x75 [13.19/32"x13/16"x2.15/16"]	mm 300 [11.13/16"]	\$ 1,615.00

Due to its particular design, this pull cannot be produced in any satin or matt finishes. Call for details.

**Note:** Complete with fixing systems for single and back to back mounting on wood (X0526, X0523) and glass doors (X0525, X0523).



### Sizes/Misure

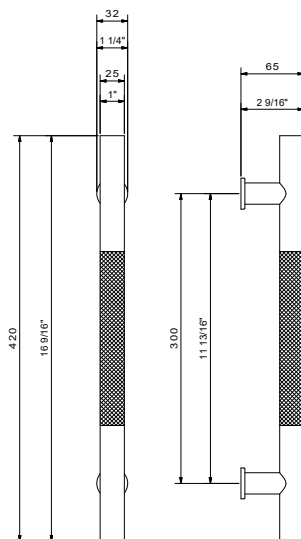

Conversions from metric to U.S. measurements are approximate.

### K 379 SINGLE

Finish	Size	Dimension	Center to center	Retail price
03M	300	mm 420x32x65 [16.9/16"x1.1/4"x2.9/16"]	mm 300 [11.13/16"]	\$ 550.00
06M	300	mm 420x32x65 [16.9/16"x1.1/4"x2.9/16"]	mm 300 [11.13/16"]	\$ 620.00
26D	300	mm 420x32x65 [16.9/16"x1.1/4"x2.9/16"]	mm 300 [11.13/16"]	\$ 699.00

### K 379/K 379 S - BACK TO BACK

Finish	Size	Dimension	Center to center	Retail price
03M	300	mm 420x32x65 [16.9/16"x1.1/4"x2.9/16"]	mm 300 [11.13/16"]	\$ 1,164.00
06M	300	mm 420x32x65 [16.9/16"x1.1/4"x2.9/16"]	mm 300 [11.13/16"]	\$ 1,304.00
26D	300	mm 420x32x65 [16.9/16"x1.1/4"x2.9/16"]	mm 300 [11.13/16"]	\$ 1,462.00

**Note:** Complete with fixing systems for single and back to back mounting on wood (X0526, X0523) and glass doors (X0525, X0523).



### Sizes/Misure

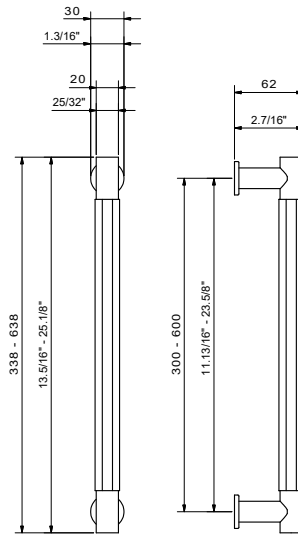

Conversions from metric to U.S. measurements are approximate.

### K 380 SINGLE

Finish	Size	Dimension	Center to center	Retail price
14	300	mm 338x30x62 [13.15/16"x1.3/16"x2.7/16"]	mm 300 [11.13/16"]	\$ 580.00
	600	mm 638x30x62 [25.1/8"x1.3/16"x2.7/16"]	mm 600 [23.5/8"]	\$ 799.00
26D	300	mm 338x30x62 [13.15/16"x1.3/16"x2.7/16"]	mm 300 [11.13/16"]	\$ 550.00
	600	mm 638x30x62 [25.1/8"x1.3/16"x2.7/16"]	mm 600 [23.5/8"]	\$ 769.00
56	300	mm 338x30x62 [13.15/16"x1.3/16"x2.7/16"]	mm 300 [11.13/16"]	\$ 580.00
	600	mm 638x30x62 [25.1/8"x1.3/16"x2.7/16"]	mm 600 [23.5/8"]	\$ 799.00

### K 380/K 380 S - BACK TO BACK

Finish	Size	Dimension	Center to center	Retail price
14	300	mm 338x30x62 [13.15/16"x1.3/16"x2.7/16"]	mm 300 [11.13/16"]	\$ 1,224.00
	600	mm 638x30x62 [25.1/8"x1.3/16"x2.7/16"]	mm 600 [23.5/8"]	\$ 1,662.00
26D	300	mm 338x30x62 [13.15/16"x1.3/16"x2.7/16"]	mm 300 [11.13/16"]	\$ 1,164.00
	600	mm 638x30x62 [25.1/8"x1.3/16"x2.7/16"]	mm 600 [23.5/8"]	\$ 1,602.00
56	300	mm 338x30x62 [13.15/16"x1.3/16"x2.7/16"]	mm 300 [11.13/16"]	\$ 1,224.00
	600	mm 638x30x62 [25.1/8"x1.3/16"x2.7/16"]	mm 600 [23.5/8"]	\$ 1,662.00

**Note:** Complete with fixing systems for single and back to back mounting on wood (X0526, X0523) and glass doors (X0525, X0523).

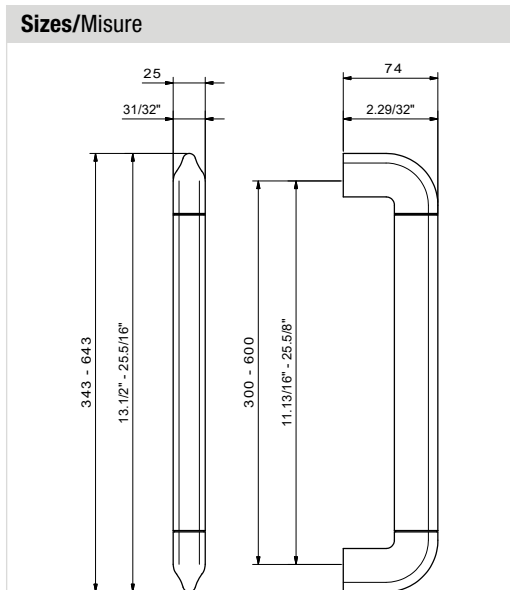

Conversions from metric to U.S. measurements are approximate.

## K 381 SINGLE

Finish	Size	Dimension	Center to center	Retail price
03M	300	mm 343x25x74 [13.1/2"x31/32"x2.29/32"]	mm 300 [11.13/16"]	\$ 399.00
	600	mm 643x25x74 [25.5/16"x31/32"x2.9/32"]	mm 600 [23.5/8"]	\$ 559.00
15	300	mm 343x25x74 [13.1/2"x31/32"x2.29/32"]	mm 300 [11.13/16"]	\$ 415.00
	600	mm 643x25x74 [25.5/16"x31/32"x2.9/32"]	mm 600 [23.5/8"]	\$ 575.00
17A	300	mm 343x25x74 [13.1/2"x31/32"x2.29/32"]	mm 300 [11.13/16"]	\$ 450.00
	600	mm 643x25x74 [25.5/16"x31/32"x2.9/32"]	mm 600 [23.5/8"]	\$ 610.00
26D	300	mm 343x25x74 [13.1/2"x31/32"x2.29/32"]	mm 300 [11.13/16"]	\$ 415.00
	600	mm 643x25x74 [25.5/16"x31/32"x2.9/32"]	mm 600 [23.5/8"]	\$ 575.00

## K 381/K 381 S - BACK TO BACK

Finish	Size	Dimension	Center to center	Retail price
03M	300	mm 343x25x74 [13.1/2"x31/32"x2.29/32"]	mm 300 [11.13/16"]	\$ 862.00
	600	mm 643x25x74 [25.5/16"x31/32"x2.9/32"]	mm 600 [23.5/8"]	\$ 1,182.00
15	300	mm 343x25x74 [13.1/2"x31/32"x2.29/32"]	mm 300 [11.13/16"]	\$ 894.00
	600	mm 643x25x74 [25.5/16"x31/32"x2.9/32"]	mm 600 [23.5/8"]	\$ 1,214.00
17A	300	mm 343x25x74 [13.1/2"x31/32"x2.29/32"]	mm 300 [11.13/16"]	\$ 964.00
	600	mm 643x25x74 [25.5/16"x31/32"x2.9/32"]	mm 600 [23.5/8"]	\$ 1,284.00
26D	300	mm 343x25x74 [13.1/2"x31/32"x2.29/32"]	mm 300 [11.13/16"]	\$ 894.00
	600	mm 643x25x74 [25.5/16"x31/32"x2.9/32"]	mm 600 [23.5/8"]	\$ 1,214.00

**Note:** Complete with fixing systems for single and back to back mounting on wood (X0526, X0523) and glass doors (X0525, X0523).

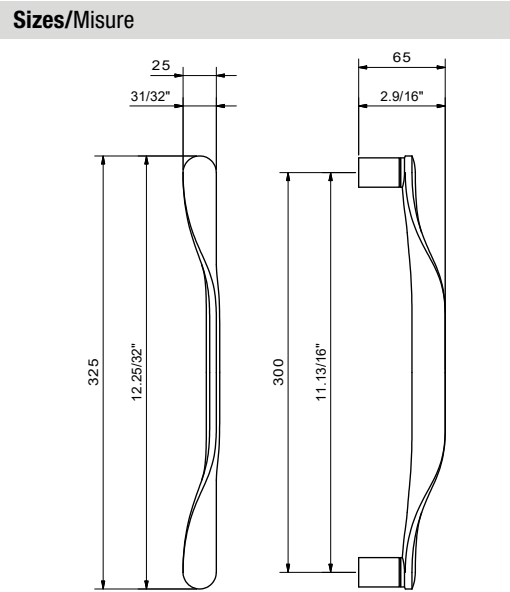

Conversions from metric to U.S. measurements are approximate.

### K 383 SINGLE

Finish	Size	Dimension	Center to center	Retail price
15	300	mm 325x25x65 [12.25/32"x31/32"x2.9/16"]	mm 300 [11.13/16"]	\$ 540.00
16	300	mm 325x25x65 [12.25/32"x31/32"x2.9/16"]	mm 300 [11.13/16"]	\$ 490.00
26D	300	mm 325x25x65 [12.25/32"x31/32"x2.9/16"]	mm 300 [11.13/16"]	\$ 540.00
56	300	mm 325x25x65 [12.25/32"x31/32"x2.9/16"]	mm 300 [11.13/16"]	\$ 590.00

### K 383/K 383 S - BACK TO BACK

Finish	Size	Dimension	Center to center	Retail price
15	300	mm 325x25x65 [12.25/32"x31/32"x2.9/16"]	mm 300 [11.13/16"]	\$ 1,144.00
16	300	mm 325x25x65 [12.25/32"x31/32"x2.9/16"]	mm 300 [11.13/16"]	\$ 1,044.00
26D	300	mm 325x25x65 [12.25/32"x31/32"x2.9/16"]	mm 300 [11.13/16"]	\$ 1,144.00
56	300	mm 325x25x65 [12.25/32"x31/32"x2.9/16"]	mm 300 [11.13/16"]	\$ 1,244.00

**Note:** Complete with fixing systems for single and back to back mounting on wood (X0526, X0523) and glass doors (X0525, X0523).









handlesets

# K 1810 Entry handleset



## Sizes/Misure

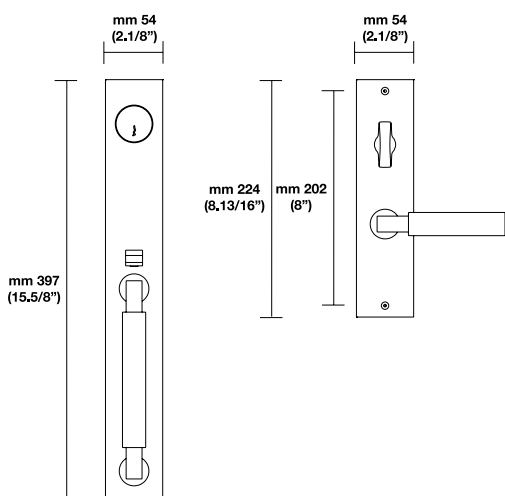

## ML-TP F Entry Handleset

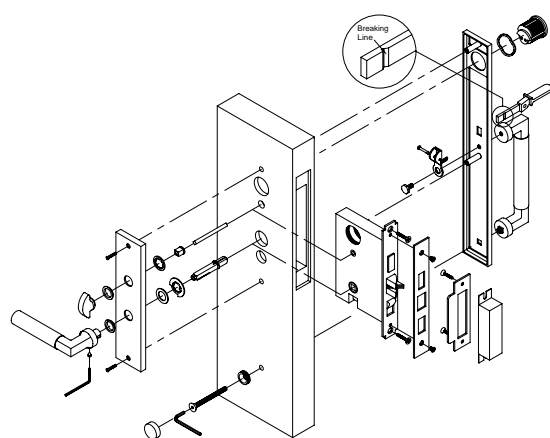

# K 1810 Entry handleset

Any lever of the Valli&Valli collection can be used as interior trim. Choose a model from one of the groups below.

## GROUP I

H315, H317, H326, H327, H330, H334, H338, H348, H361, H364, H367, H368, H370, H372, H381, H382, H383

Finish	Retail Price	
	Entry/ENT	Dummy Set/FD
 26	\$ 1,403.00	\$ 715.00
 26D	\$ 1,439.00	\$ 726.00

## GROUP II

H311, H329, H335, H343, H359, H369, H376, H378, H384, K378, K383

Finish	Retail Price	
	Entry/ENT	Dummy Set/FD
 26	\$ 1,462.00	\$ 785.00
 26D	\$ 1,497.00	\$ 795.00

## GROUP III

H350, H377, K377

Finish	Retail Price	
	Entry/ENT	Dummy Set/FD
 26	\$ 1,637.00	\$ 960.00
 26D	\$ 1,660.00	\$ 971.00

## GROUP IV

H354, H356, H379, H380

Finish	Retail Price	
	Entry/ENT	Dummy Set/FD
 26	\$ 1,660.00	\$ 995.00
 26D	\$ 1,696.00	\$ 1,018.00

The finishes above are considered standard.  
 Different finishes are available upon special request.  
 See pages 20-21 for more options and page 15 for pricing.



# K 1868 Entry handleset



## Sizes/Misure

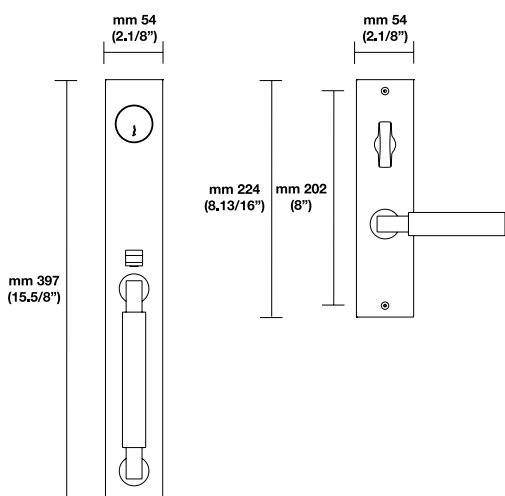

## ML-TP F Entry Handleset

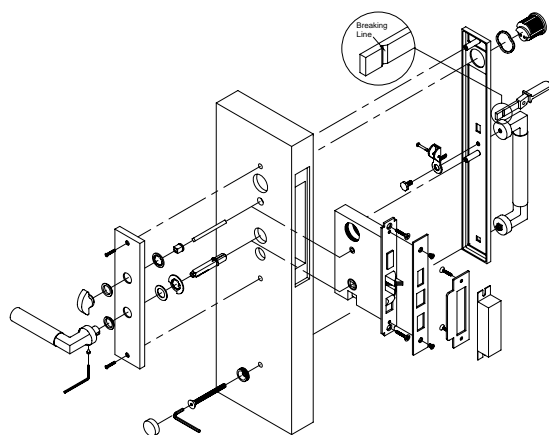

# K 1868 Entry handleset

Any lever of the Valli&Valli collection can be used as interior trim. Choose a model from one of the groups below.

## GROUP I

H315, H317, H326, H327, H330, H334, H338, H348, H361, H364, H367, H368, H370, H372, H381, H382, H383

Finish	Retail Price	
	Entry/ENT	Dummy Set/FD
 26	\$ 1,403.00	\$ 715.00
 26D	\$ 1,439.00	\$ 726.00

## GROUP II

H311, H329, H335, H343, H359, H369, H376, H378, H384, K378, K383

Finish	Retail Price	
	Entry/ENT	Dummy Set/FD
 26	\$ 1,462.00	\$ 785.00
 26D	\$ 1,497.00	\$ 795.00

## GROUP III

H350, H377, K377

Finish	Retail Price	
	Entry/ENT	Dummy Set/FD
 26	\$ 1,637.00	\$ 960.00
 26D	\$ 1,660.00	\$ 971.00

## GROUP IV

H354, H356, H379, H380

Finish	Retail Price	
	Entry/ENT	Dummy Set/FD
 26	\$ 1,660.00	\$ 995.00
 26D	\$ 1,696.00	\$ 1,018.00

The finishes above are considered standard.  
 Different finishes are available upon special request.  
 See pages 20-21 for more options and page 15 for pricing.

# K 1869 Entry handleset



## Sizes/Misure

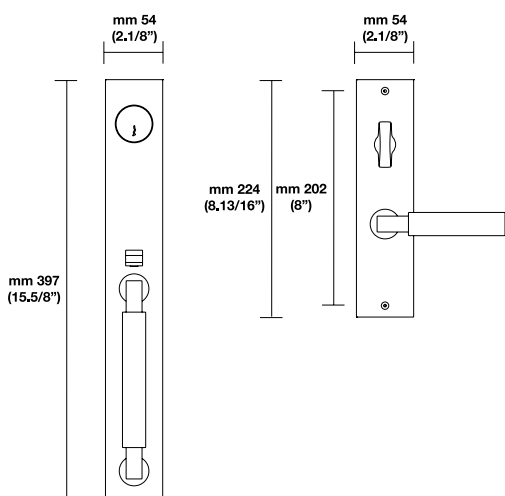

## ML-TP F Entry Handleset

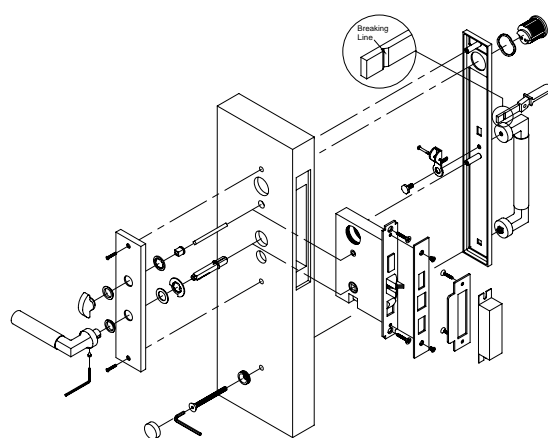

# K 1869 Entry handleset

Any lever of the Valli&Valli collection can be used as interior trim. Choose a model from one of the groups below.

## GROUP I

H315, H317, H326, H327, H330, H334, H338, H348, H361, H364, H367, H368, H370, H372, H381, H382, H383

Finish	Retail Price	
	Entry/ENT	Dummy Set/FD
 26	\$ 1,403.00	\$ 715.00
 26D	\$ 1,439.00	\$ 726.00

## GROUP II

H311, H329, H335, H343, H359, H369, H376, H378, H384, K378, K383

Finish	Retail Price	
	Entry/ENT	Dummy Set/FD
 26	\$ 1,462.00	\$ 785.00
 26D	\$ 1,497.00	\$ 795.00

## GROUP III

H350, H377, K377

Finish	Retail Price	
	Entry/ENT	Dummy Set/FD
 26	\$ 1,637.00	\$ 960.00
 26D	\$ 1,660.00	\$ 971.00

## GROUP IV

H354, H356, H379, H380

Finish	Retail Price	
	Entry/ENT	Dummy Set/FD
 26	\$ 1,660.00	\$ 995.00
 26D	\$ 1,696.00	\$ 1,018.00

The finishes above are considered standard.  
 Different finishes are available upon special request.  
 See pages 20-21 for more options and page 15 for pricing.



# K 1870 Entry handleset



## Sizes/Misure

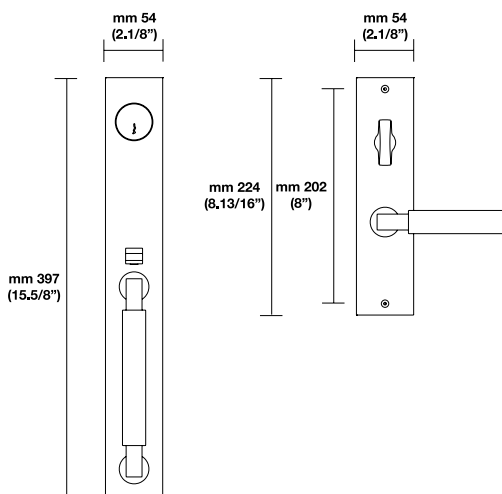

## ML-TP F Entry Handleset

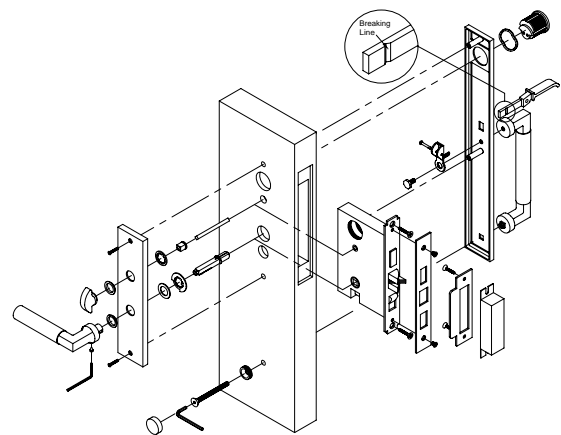

# K 1870 Entry handleset

Any lever of the Valli&Valli collection can be used as interior trim. Choose a model from one of the groups below.

## GROUP I

H315, H317, H326, H327, H330, H334, H338, H348, H361, H364, H367, H368, H370, H372, H381, H382, H383

Finish	Retail Price	
	Entry/ENT	Dummy Set/FD
 26	\$ 1,403.00	\$ 715.00
 26D	\$ 1,439.00	\$ 726.00

## GROUP II

H311, H329, H335, H343, H359, H369, H376, H378, H384, K378, K383

Finish	Retail Price	
	Entry/ENT	Dummy Set/FD
 26	\$ 1,462.00	\$ 785.00
 26D	\$ 1,497.00	\$ 795.00

## GROUP III

H350, H377, K377

Finish	Retail Price	
	Entry/ENT	Dummy Set/FD
 26	\$ 1,637.00	\$ 960.00
 26D	\$ 1,660.00	\$ 971.00

## GROUP IV

H354, H356, H379, H380

Finish	Retail Price	
	Entry/ENT	Dummy Set/FD
 26	\$ 1,660.00	\$ 995.00
 26D	\$ 1,696.00	\$ 1,018.00

The finishes above are considered standard.  
 Different finishes are available upon special request.  
 See pages 20-21 for more options and page 15 for pricing.





# pocket doors

# K 3012 Serie AC3 Duemilaquattro

design Antonio Citterio with Toan Nguyen



## Sizes/Misure

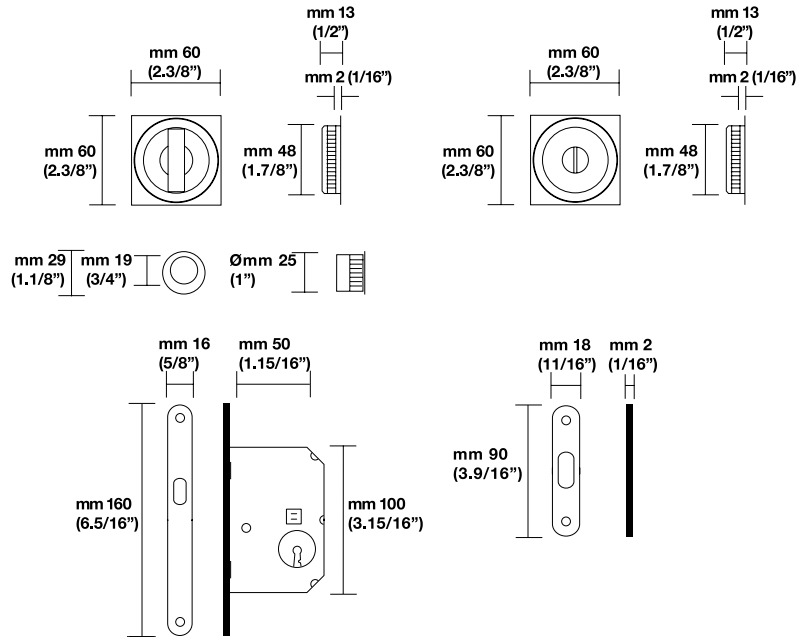

Conversions from metric to U.S. measurements are approximate.

### K 3012 PRIVACY (Complete set with lock and recessed finger pull)

Finish	Dimension	Retail Price	
		Door thickness 1.3/4"	Door thickness 1.3/8"
14	mm 60x60x13 [2.3/8"x2.3/8"x1/2"]	\$ 396.00	\$ 455.00
15	mm 60x60x13 [2.3/8"x2.3/8"x1/2"]	\$ 396.00	\$ 455.00
26	mm 60x60x13 [2.3/8"x2.3/8"x1/2"]	\$ 350.00	\$ 397.00
26D	mm 60x60x13 [2.3/8"x2.3/8"x1/2"]	\$ 367.00	\$ 413.00

The privacy flush pulls accommodate 1.3/4" and 1.3/8" door thickness. 1.3/8" door thickness requires minimum pocket width of 2.1/6", a spacer will add 1/8" to surface on both sides of the door.

The finishes above are considered standard. For different finish options see page 20 and pricing at page 15.

The Thumbturn protrudes 7/32" from surface plate. The pocket door Thumbturn does not flush complete.

**Satin nickel** trims are combined with Satin chrome face and strike plates.  
**Polished nickel** trims are combined with Polished chrome face and strike plates.

# K 3014 Serie AC3 Duemilaquattro

design Antonio Citterio with Toan Nguyen



## Sizes/Misure

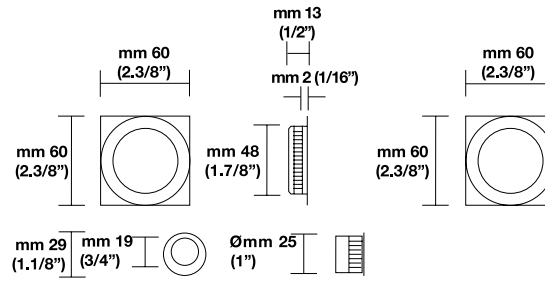

Conversions from metric to U.S. measurements are approximate.

### K 3014 PASSAGE (Complete set with recessed finger pull)

Finish	Dimension	Retail Price
14	mm 60x60x13 [2.3/8"x2.3/8"x1/2"]	\$ 228.00
15	mm 60x60x13 [2.3/8"x2.3/8"x1/2"]	\$ 238.00
26	mm 60x60x13 [2.3/8"x2.3/8"x1/2"]	\$ 204.00
26D	mm 60x60x13 [2.3/8"x2.3/8"x1/2"]	\$ 214.00

The privacy flush pulls accommodate 1.3/4" and 1.3/8" door thickness.

1.3/8" door thickness requires minimum pocket width of 2.1/6", a spacer will add 1/8" to surface on both sides of the door.

The finishes above are considered standard.

For different finish options see page 20 and pricing at page 15.

The Thumbturn protrudes 7/32" from surface plate.

The pocket door Thumbturn does not flush complete.

**Satin nickel** trims are combined with Satin chrome face and strike plates.

**Polished nickel** trims are combined with Polished chrome face and strike plates.



stainless  
steel  
door levers



# H 5008 Serie Himalaya

design Taller Design Ricardo Boffill  
Material: **Stainless Steel AISI 316 L**

## GROUP I INOX Matching elements

- Pg 112** Mortise lock functions
- Pg 130** Deadbolts
- Pg 136** Privacy Bolts
- Pg 142** Escutcheons with deadbolts
- Pg 148** Multi-Point Trim functions

Window lever available in the same design  
Call for pricing



### Sizes/Misure

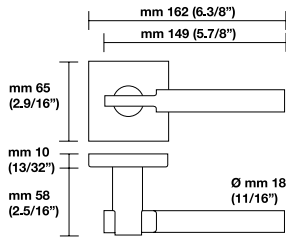

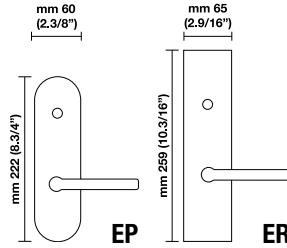

### Escutcheon options/Opzioni





Conversions from metric to U.S. measurements are approximate.

### Retail Price

Finish	Round	Square	Small 2"	PGE	PCY	DMY R/L Single	ML-F ENTRY
							
	<b>RPS</b>			\$ 662.00	\$ 682.00	\$ 320.00	\$ 1,403.00
		<b>RQS</b>		\$ 817.00	\$ 854.00	\$ 408.00	\$ 1,427.00
32D			<b>RSS</b>	\$ 632.00	\$ 805.00 <sup>1</sup>	\$ 300.00	\$ 1,164.00

<sup>1</sup> It does not fit a privacy pin. Supplied with 105 RSS Privacy Bolt

Finish	Oval	Rectangular	PGE	PCY	DMY R/L Single	DMY R/L Pair	ML-F ENTRY
							
	<b>NES</b>		\$ 819.00	\$ 889.00	\$ 411.00	\$ 795.00	\$ 1,206.00
32D		<b>ERS</b>	\$ 878.00	\$ 912.00	\$ 445.00	\$ 832.00	\$ 1,240.00

**Note:** RSS Trims (2") not recommended for commercial use

The options listed above are considered standard.  
Non-standard options are available upon request.

For more options on **Rosettes and Escutcheon plates**  
see pages 16-17.

#### Upcharges apply for the following special options:

- Extra thick door (> 2")
  - Non-standard rosettes (rosettes not listed above)
  - Non-standard finishes (finishes not listed above)
  - Split finishes
- See page 15 for pricing. Exclusions may apply.

# H 5014 Serie Bernina

design Fusital Workshop

Material: **Stainless Steel AISI 316 L**

## GROUP IV INOX

### Matching elements

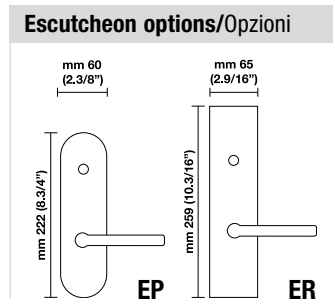
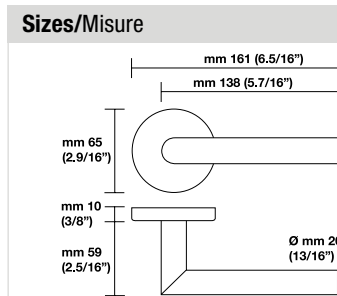

- Pg 112** Mortise lock functions
- Pg 130** Deadbolts
- Pg 136** Privacy Bolts
- Pg 142** Escutcheons with deadbolts
- Pg 148** Multi-Point Trim functions

Window lever available in the same design  
Call for pricing





Conversions from metric to U.S. measurements are approximate.

### Retail Price

Finish	Round	Square	Small 2"	PGE	PCY	DMY R/L Single	ML-F ENTRY
							
	<b>RPS</b>			\$ 432.00	\$ 466.00	\$ 210.00	\$ 1,216.00
		<b>RQS</b>		\$ 542.00	\$ 576.00	\$ 265.00	\$ 1,240.00
32			<b>RSS</b>	\$ 390.00	\$ 608.00 <sup>1</sup>	\$ 177.00	\$ 971.00
	<b>RPS</b>			\$ 373.00	\$ 383.00	\$ 185.00	\$ 1,216.00
		<b>RQS</b>		\$ 483.00	\$ 493.00	\$ 240.00	\$ 1,240.00
32D			<b>RSS</b>	\$ 333.00	\$ 507.00 <sup>1</sup>	\$ 153.00	\$ 971.00

<sup>1</sup> It does not fit a privacy pin. Supplied with 105 RSS Privacy Bolt

Finish	Oval	Rectangular	PGE	PCY	DMY R/L Single	DMY R/L Pair	ML-F ENTRY
							
	<b>NES</b>		\$ 667.00	\$ 702.00	\$ 341.00	\$ 621.00	\$ 1,018.00
32D		<b>ERS</b>	\$ 706.00	\$ 716.00	\$ 364.00	\$ 657.00	\$ 1,041.00

**Note:** RSS Trims (2") not recommended for commercial use

The options listed above are considered standard.  
Non-standard options are available upon request.

For more options on **Rosettes and Escutcheon plates**  
see pages 16-17.

**Upcharges** apply for the following special options:

- Extra thick door (> 2")
  - Non-standard rosettes (rosettes not listed above)
  - Non-standard finishes (finishes not listed above)
  - Split finishes
- See page 15 for pricing. Exclusions may apply.

# H 5015 Serie K2

design Antonio Citterio

Material: **Stainless Steel AISI 316 L**



## GROUP II INOX Matching elements

- Pg 112** Mortise lock functions
- Pg 130** Deadbolts
- Pg 136** Privacy Bolts
- Pg 142** Escutcheons with deadbolts
- Pg 148** Multi-Point Trim functions

Window lever available in the same design  
Call for pricing

### Sizes/Misure

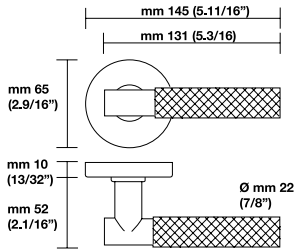

### Escutcheon options/Opzioni

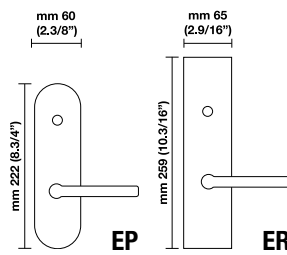

Conversions from metric to U.S. measurements are approximate.



See page 18  
for details

### Retail Price

Finish	Round	Square	Small 2"	PGE	PCY	DMY R/L Single	ML-F ENTRY
	<b>RPS</b>			\$ 1.076.00	\$ 1.111.00	\$ 533.00	\$ 1,707.00
		<b>RQS</b>		\$ 1.186.00	\$ 1.221.00	\$ 588.00	\$ 1,730.00
32			<b>RSS</b>	\$ 1.038.00	\$ 1.234.00 <sup>1</sup>	\$ 501.00	\$ 1,462.00
	<b>RPS</b>			\$ 854.00	\$ 866.00	\$ 414.00	\$ 1,707.00
		<b>RQS</b>		\$ 964.00	\$ 976.00	\$ 469.00	\$ 1,730.00
32D			<b>RSS</b>	\$ 817.00	\$ 990.00 <sup>1</sup>	\$ 396.00	\$ 1,462.00

<sup>1</sup> It does not fit a privacy pin. Supplied with 105 RSS Privacy Bolt

Finish	Oval	Rectangular	PGE	PCY	DMY R/L Single	DMY R/L Pair	ML-F ENTRY
	<b>NES</b>		\$ 1,158.00	\$ 1,170.00	\$ 586.00	\$ 1,111.00	\$ 1,497.00
32D		<b>ERS</b>	\$ 1,226.00	\$ 1,193.00	\$ 620.00	\$ 1,177.00	\$ 1,544.00

**Note:** RSS Trims (2") not recommended for commercial use

The options listed above are considered standard.  
Non-standard options are available upon request.

For more options on **Rosettes and Escutcheon plates**  
see pages 16-17.

**Upcharges** apply for the following special options:

- Extra thick door (> 2")
- Non-standard rosettes (rosettes not listed above)
- Non-standard finishes (finishes not listed above)
- Split finishes

See page 15 for pricing. Exclusions may apply.

# H 5015 Serie K2

design Antonio Citterio

Material: **Stainless Steel AISI 316 L + Leather**



## GROUP III INOX Matching elements



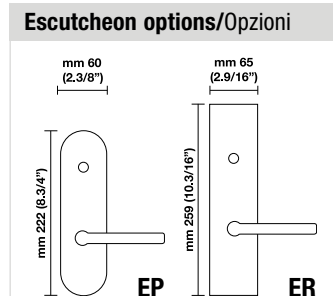
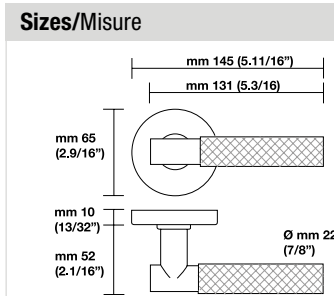

- Pg 112** Mortise lock functions
- Pg 130** Deadbolts
- Pg 136** Privacy Bolts
- Pg 142** Escutcheons with deadbolts
- Pg 148** Multi-Point Trim functions

Window lever available in the same design  
Call for pricing







Conversions from metric to U.S. measurements are approximate.

## Retail Price

Finish	Round	Square	Small 2"	PGE	PCY	DMY R/L Single	ML-F ENTRY
							
	<b>RPS</b>			\$ 1,298.00	\$ 1,335.00	\$ 648.00	\$ 2,128.00
32D/		<b>RQS</b>		\$ 1,408.00	\$ 1,445.00	\$ 703.00	\$ 2,281.00
 Black leather			<b>RSS</b>	\$ 1,278.00	\$ 1,458.00 <sup>1</sup>	\$ 622.00	\$ 1,860.00
	<b>RPS</b>			\$ 1,298.00	\$ 1,335.00	\$ 648.00	\$ 2,128.00
32D/		<b>RQS</b>		\$ 1,408.00	\$ 1,445.00	\$ 703.00	\$ 2,281.00
 Orange leather			<b>RSS</b>	\$ 1,278.00	\$ 1,458.00 <sup>1</sup>	\$ 622.00	\$ 1,860.00

<sup>1</sup> It does not fit a privacy pin. Supplied with 105 RSS Privacy Bolt

Finish	Oval	Rectangular	PGE	PCY	DMY R/L Single	DMY R/L Pair	ML-F ENTRY
							
32D/	<b>NES</b>		\$ 1,579.00	\$ 1,625.00	\$ 785.00	\$ 1,521.00	\$ 1,906.00
 Black leather		<b>ERS</b>	\$ 1,637.00	\$ 1,696.00	\$ 819.00	\$ 1,579.00	\$ 1,941.00
32D/	<b>NES</b>		\$ 1,579.00	\$ 1,625.00	\$ 785.00	\$ 1,521.00	\$ 1,906.00
 Orange leather		<b>ERS</b>	\$ 1,637.00	\$ 1,696.00	\$ 819.00	\$ 1,579.00	\$ 1,941.00

**Note:** RSS Trims (2") not recommended for commercial use

The options listed above are considered standard.  
Non-standard rosettes are available upon request.

For more options on **Rosettes and Escutcheon plates**  
see pages 16-17.

**Upcharges** apply for the following special options:

- Extra thick door (> 2")
  - Non-standard rosettes (rosettes not listed above)
  - Non-standard finishes (finishes not listed above)
  - Split finishes
- See page 15 for pricing. Exclusions may apply.

# H 5017 Serie Gottardo

design Hans Kollhoff

Material: **Stainless Steel AISI 316 L**



## GROUP II INOX Matching elements

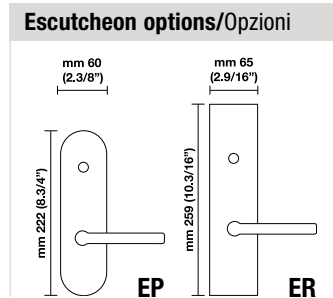
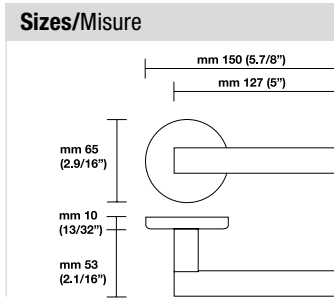

- Pg 112** Mortise lock functions
- Pg 130** Deadbolts
- Pg 136** Privacy Bolts
- Pg 142** Escutcheons with deadbolts
- Pg 148** Multi-Point Trim functions

Window lever available in the same design  
Call for pricing





Conversions from metric to U.S. measurements are approximate.

## Retail Price

Finish	Round	Square	Small 2"	PGE	PCY	DMY R/L Single	ML-F ENTRY
							
	<b>RPS</b>			\$ 1,162.00	\$ 1,199.00	\$ 570.00	\$ 1,707.00
		<b>RQS</b>		\$ 1,272.00	\$ 1,309.00	\$ 625.00	\$ 1,730.00
32			<b>RSS</b>	\$ 1,117.00	\$ 1,330.00 <sup>1</sup>	\$ 534.00	\$ 1,462.00
	<b>RPS</b>			\$ 913.00	\$ 924.00	\$ 447.00	\$ 1,707.00
		<b>RQS</b>		\$ 1,023.00	\$ 1,034.00	\$ 502.00	\$ 1,730.00
32D			<b>RSS</b>	\$ 872.00	\$ 1,058.00 <sup>1</sup>	\$ 425.00	\$ 1,462.00

<sup>1</sup> It does not fit a privacy pin. Supplied with 105 RSS Privacy Bolt

Finish	Oval	Rectangular	PGE	PCY	DMY R/L Single	DMY R/L Pair	ML-F ENTRY
							
	<b>NES</b>		\$ 1,158.00	\$ 1,170.00	\$ 586.00	\$ 1,111.00	\$ 1,497.00
32D		<b>ERS</b>	\$ 1,226.00	\$ 1,193.00	\$ 620.00	\$ 1,177.00	\$ 1,544.00

**Note:** RSS Trims (2") not recommended for commercial use

The options listed above are considered standard.  
Non-standard options are available upon request.

For more options on **Rosettes and Escutcheon plates**  
see pages 16-17.

**Upcharges** apply for the following special options:

- Extra thick door (> 2")
- Non-standard rosettes (rosettes not listed above)
- Non-standard finishes (finishes not listed above)
- Split finishes

See page 15 for pricing. Exclusions may apply.







stainless  
steel  
door knobs



# K 5301

design Fusital Workshop

Material: **Stainless Steel AISI 316 L**

## GROUP I INOX Matching elements

- Pg 112** Mortise lock functions
- Pg 130** Deadbolts
- Pg 136** Privacy Bolts
- Pg 142** Escutcheons with deadbolts



### Sizes/Misure

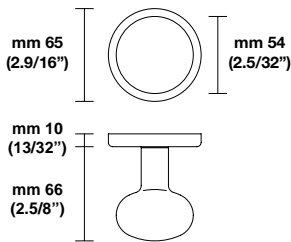

### Escutcheon options/Opzioni

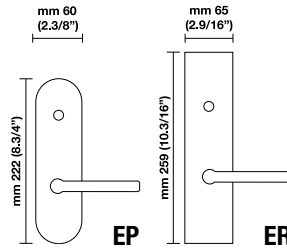

Conversions from metric to U.S. measurements are approximate.

### Retail Price

Finish	Round	Square	Small 2"	PGE	PCY	DMY R/L Single	ML-F ENTRY
32	RPS	RQS	RSS	\$ 682.00	\$ 717.00	\$ 338.00	\$ 1,403.00
				\$ 792.00	\$ 827.00	\$ 393.00	\$ 1,427.00
				\$ 637.00	\$ 854.00 <sup>1</sup>	\$ 304.00	\$ 1,164.00
32D	RPS	RQS	RSS	\$ 545.00	\$ 557.00	\$ 261.00	\$ 1,403.00
				\$ 655.00	\$ 667.00	\$ 316.00	\$ 1,427.00
				\$ 508.00	\$ 682.00 <sup>1</sup>	\$ 246.00	\$ 1,164.00

<sup>1</sup> It does not fit a privacy pin. Supplied with 105 RSS Privacy Bolt

Finish	Oval	Rectangular	PGE	PCY	DMY R/L Single	DMY R/L Pair	ML-F ENTRY
32D	NES	ERS	\$ 819.00	\$ 889.00	\$ 411.00	\$ 795.00	\$ 1,206.00
			\$ 878.00	\$ 912.00	\$ 445.00	\$ 832.00	\$ 1,240.00

**Note:** RSS Trims (2") not recommended for commercial use

The options listed above are considered standard. Non-standard options are available upon request.

For more options on **Rosettes and Escutcheon plates** see pages 16-17.

**Upcharges** apply for the following special options:

- Extra thick door (> 2")
  - Non-standard rosettes (rosettes not listed above)
  - Non-standard finishes (finishes not listed above)
  - Split finishes
- See page 15 for pricing. Exclusions may apply.

# K 5302

design Fusital Workshop

Material: **Stainless Steel AISI 316 L**

## GROUP I INOX Matching elements

- Pg 112** Mortise lock functions
- Pg 130** Deadbolts
- Pg 136** Privacy Bolts
- Pg 142** Escutcheons with deadbolts



### Sizes/Misure

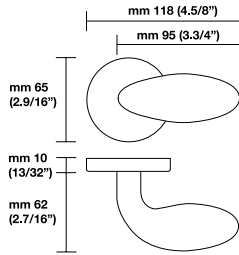

### Escutcheon options/Opzioni

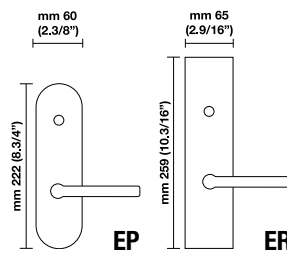

Conversions from metric to U.S. measurements are approximate.

### Retail Price

Finish	Round	Square	Small 2"	PGE	PCY	DMY R/L Single	ML-F ENTRY
	<b>RPS</b>			\$ 624.00	\$ 657.00	\$ 308.00	\$ 1,403.00
32		<b>RQS</b>		\$ 734.00	\$ 767.00	\$ 365.00	\$ 1,427.00
			<b>RSS</b>	\$ 581.00	\$ 791.00 <sup>1</sup>	\$ 276.00	\$ 1,164.00
	<b>RPS</b>			\$ 487.00	\$ 508.00	\$ 237.00	\$ 1,403.00
32D		<b>RQS</b>		\$ 597.00	\$ 618.00	\$ 294.00	\$ 1,427.00
			<b>RSS</b>	\$ 456.00	\$ 624.00 <sup>1</sup>	\$ 217.00	\$ 1,164.00

<sup>1</sup> It does not fit a privacy pin. Supplied with 105 RSS Privacy Bolt

Finish	Oval	Rectangular	PGE	PCY	DMY R/L Single	DMY R/L Pair	ML-F ENTRY
	<b>NES</b>		\$ 819.00	\$ 889.00	\$ 411.00	\$ 795.00	\$ 1,206.00
32D		<b>ERS</b>	\$ 878.00	\$ 912.00	\$ 445.00	\$ 832.00	\$ 1,240.00

**Note:** RSS Trims (2") not recommended for commercial use

The options listed above are considered standard. Non-standard options are available upon request.

For more options on **Rosettes and Escutcheon plates** see pages 16-17.

**Upcharges** apply for the following special options:

- Extra thick door (> 2")
  - Non-standard rosettes (rosettes not listed above)
  - Non-standard finishes (finishes not listed above)
  - Split finishes
- See page 15 for pricing. Exclusions may apply.



stainless  
steel  
door pulls

# P 5405 Serie Himalaya

design Taller Design Ricardo Boffill

Material: **Stainless Steel AISI 316 L**

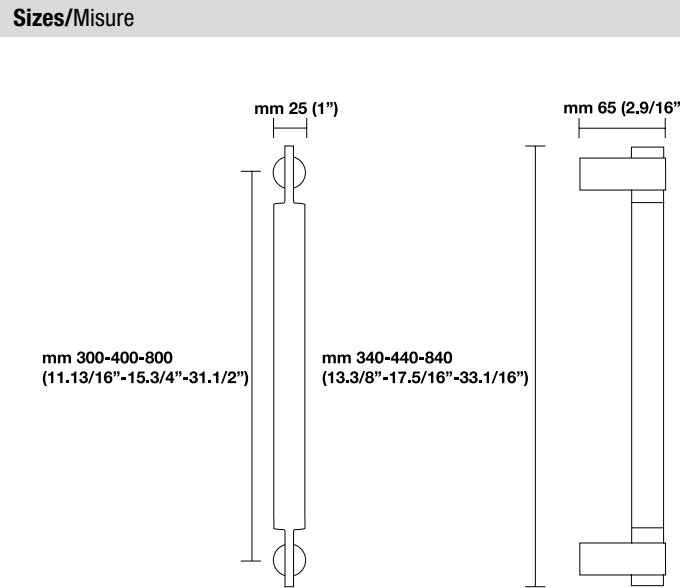

Conversions from metric to U.S. measurements are approximate.

## P 5405 SINGLE

Finish	Size	Dimension	Center to center	Retail price
32	300	mm 340x25x65 [13.3/8"x1"x2.9/16"]	mm 300 [11.13/16"]	\$ 938.00
	400	mm 440x25x65 [17.5/16"x1"x2.9/16"]	mm 400 [15.3/4"]	\$ 1,191.00
	800	mm 840x25x65 [33.1/16"x1"x2.9/16"]	mm 800 [31.1/2"]	\$ 1,452.00
32D	300	mm 340x25x65 [13.3/8"x1"x2.9/16"]	mm 300 [11.13/16"]	\$ 723.00
	400	mm 440x25x65 [17.5/16"x1"x2.9/16"]	mm 400 [15.3/4"]	\$ 911.00
	800	mm 840x25x65 [33.1/16"x1"x2.9/16"]	mm 800 [31.1/2"]	\$ 1,110.00

## P 5405/P 5405 S - BACK TO BACK

Finish	Size	Dimension	Center to center	Retail price
32	300	mm 340x25x65 [13.3/8"x1"x2.9/16"]	mm 300 [11.13/16"]	\$ 1,980.00
	400	mm 440x25x65 [17.5/16"x1"x2.9/16"]	mm 400 [15.3/4"]	\$ 2,484.00
	800	mm 840x25x65 [33.1/16"x1"x2.9/16"]	mm 800 [31.1/2"]	\$ 3,005.00
32D	300	mm 340x25x65 [13.3/8"x1"x2.9/16"]	mm 300 [11.13/16"]	\$ 1,546.00
	400	mm 440x25x65 [17.5/16"x1"x2.9/16"]	mm 400 [15.3/4"]	\$ 1,921.00
	800	mm 840x25x65 [33.1/16"x1"x2.9/16"]	mm 800 [31.1/2"]	\$ 2,320.00

**Note:** Complete with fixing systems for single and back to back mounting on wood (X0510, X0509) and glass doors (X0508, X0510).

# P 5406 Serie K2

design Antonio Citterio

Material: **Stainless Steel AISI 316 L**

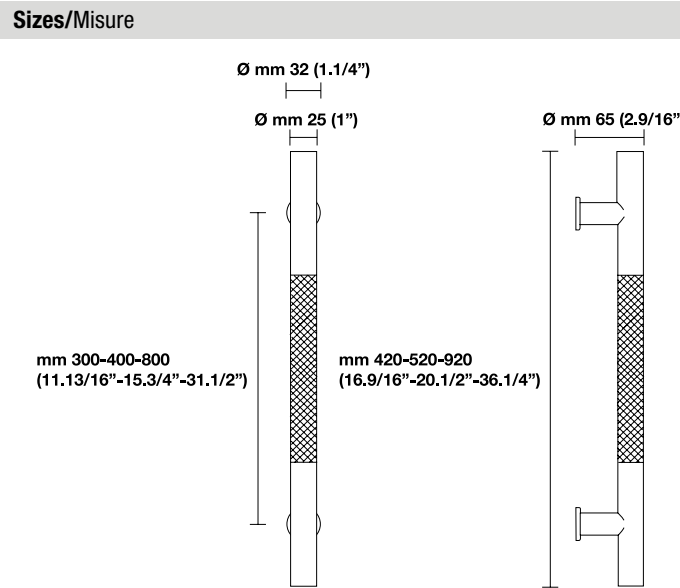

Conversions from metric to U.S. measurements are approximate.

## P 5406 SINGLE

Finish	Size	Dimension	Center to center	Retail price
32	300	mm 420x25x65 [16.9/16"x1"x2.9/16"]	mm 300 [11.13/16"]	\$ 949.00
	400	mm 520x25x65 [20.1/2"x1"x2.9/16"]	mm 400 [15.3/4"]	\$ 1,307.00
	800	mm 920x25x65 [36.1/4"x1"x2.9/16"]	mm 800 [31.1/2"]	\$ 1,594.00
32D	300	mm 420x25x65 [16.9/16"x1"x2.9/16"]	mm 300 [11.13/16"]	\$ 762.00
	400	mm 520x25x65 [20.1/2"x1"x2.9/16"]	mm 400 [15.3/4"]	\$ 1,001.00
	800	mm 920x25x65 [36.1/4"x1"x2.9/16"]	mm 800 [31.1/2"]	\$ 1,218.00

## P 5406/P 5406 S - BACK TO BACK

Finish	Size	Dimension	Center to center	Retail price
32	300	mm 420x25x65 [16.9/16"x1"x2.9/16"]	mm 300 [11.13/16"]	\$ 2,000.00
	400	mm 520x25x65 [20.1/2"x1"x2.9/16"]	mm 400 [15.3/4"]	\$ 2,716.00
	800	mm 920x25x65 [36.1/4"x1"x2.9/16"]	mm 800 [31.1/2"]	\$ 3,288.00
32D	300	mm 420x25x65 [16.9/16"x1"x2.9/16"]	mm 300 [11.13/16"]	\$ 1,624.00
	400	mm 520x25x65 [20.1/2"x1"x2.9/16"]	mm 400 [15.3/4"]	\$ 2,098.00
	800	mm 920x25x65 [36.1/4"x1"x2.9/16"]	mm 800 [31.1/2"]	\$ 2,534.00

**Note:** Complete with fixing systems for single and back to back mounting on wood (X0510, X0509) and glass doors (X0508, X0510).

# P 5408 Serie K2

design Antonio Citterio

Material: **Stainless Steel AISI 316 L**



## Sizes/Misure

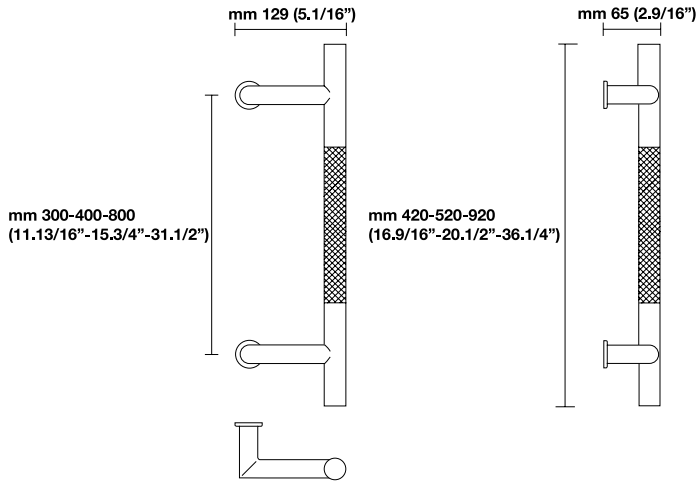

Conversions from metric to U.S. measurements are approximate.

### P 5408 SINGLE

Finish	Size	Dimension	Center to center	Retail price
32	300	mm 420x129x65 [16.9/16" x 5.1/16" x 2.9/16"]	mm 300 [11.13/16"]	\$ 1,695.00
	400	mm 5200x129x65 [20.1/2" x 5.1/16" x 2.9/16"]	mm 400 [15.3/4"]	\$ 2,001.00
	800	mm 920x129x65 [36.1/4" x 5.1/16" x 2.9/16"]	mm 800 [31.1/2"]	\$ 2,313.00
32D	300	mm 420x129x65 [16.9/16" x 5.1/16" x 2.9/16"]	mm 300 [11.13/16"]	\$ 1,308.00
	400	mm 5200x129x65 [20.1/2" x 5.1/16" x 2.9/16"]	mm 400 [15.3/4"]	\$ 1,535.00
	800	mm 920x129x65 [36.1/4" x 5.1/16" x 2.9/16"]	mm 800 [31.1/2"]	\$ 1,774.00

### P 5408/P 5408 S - BACK TO BACK

Finish	Size	Dimension	Center to center	Retail price
32	300	mm 420x129x65 [16.9/16" x 5.1/16" x 2.9/16"]	mm 300 [11.13/16"]	\$ 3,493.00
	400	mm 5200x129x65 [20.1/2" x 5.1/16" x 2.9/16"]	mm 400 [15.3/4"]	\$ 4,104.00
	800	mm 920x129x65 [36.1/4" x 5.1/16" x 2.9/16"]	mm 800 [31.1/2"]	\$ 4,727.00
32D	300	mm 420x129x65 [16.9/16" x 5.1/16" x 2.9/16"]	mm 300 [11.13/16"]	\$ 2,719.00
	400	mm 5200x129x65 [20.1/2" x 5.1/16" x 2.9/16"]	mm 400 [15.3/4"]	\$ 3,264.00
	800	mm 920x129x65 [36.1/4" x 5.1/16" x 2.9/16"]	mm 800 [31.1/2"]	\$ 3,647.00

**Note:** Complete with fixing systems for single and back to back mounting on wood (X0510, X0509) and glass doors (X0508, X0510).









# mortise locks

# Mortise locks

Each lever and knob design in this catalog is available for mortise lock application. Valli&Valli provides mortise locks of different backsets and functions.

## 1. Standard backset lock

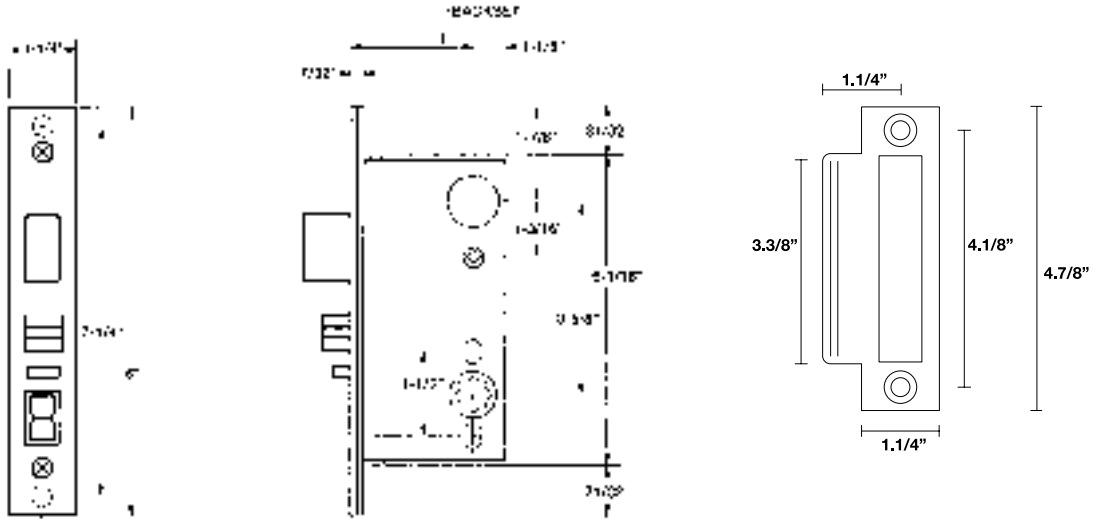

Lock front (Shown ML-FD function)

Lock body (Shown ML-FD function)

Universal Strike plate

## 2. Narrow backset lock

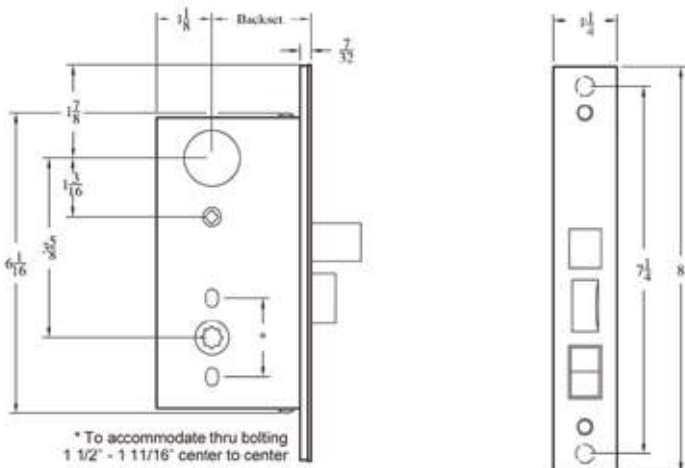

\* To accommodate thru bolting  
1 1/2" - 1 11/16" center to center

**STANDARD BACKSETS:** 2.3/4" - 2.1/2"

**SPECIAL BACKSETS ON REQUEST:**

1.1/4" - 1.1/2" - 1.3/4" - 2" - 2.1/4" - 3" - 5"  
Different customized backsets may be produced upon special request and after technical approval.

**Upcharges** apply to different backset requests. See page 15 for details.

Magnetic mortise locks also available on request. See page 15 for pricing



## ML-F ENTRANCE

Latch bolt by key outside and lever either side unless outside lever is locked by toggle-action stop.  
Dead bolt by key outside and turnpiece inside.  
Turning inside lever retracts latch and dead bolt simultaneously. Outside lever remains locked.



## ML-ELECT ELECTRIFIED

Must Specify: EU = Fail secure or EL = Fail safe  
Voltage: 24 VDC or 12 VDC  
Latch by lever inside and key outside.  
Outside lever is always rigid.  
Auxiliary latch deadlocks latch bolt.



## ML-FW DORMITORY

Latch bolt by lever either side.  
Dead bolt by key outside and turnpiece inside.  
A turn of inside lever retracts latch and dead bolt simultaneously-automatically unlocking outside lever.  
No Toggle.



## ML-J CLASSROOM

Latch bolt by key outside and lever either side unless outside lever is locked by key outside.  
Auxiliary latch deadlocks latch bolt.



## ML-AC ENTRANCE

Latch bolt by lever either side unless outside lever is locked by toggle action stop.  
Dead bolt by key either side.



## ML-LF PRIVACY

Latch bolt by lever either side.  
Dead bolt by turnpiece inside and coin key outside.  
A turn of inside lever retracts latch and dead bolt simultaneously-automatically unlocking outside lever.



## ML-B ENTRANCE

Latch bolt by lever either side.  
Dead bolt by key outside and thumbturn inside.  
No Toggle. No emergency egress.



## ML-N PASSAGE

Latch bolt by lever either side.

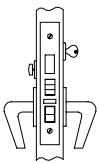

## ML-FD ENTRANCE / APARTMENT LOCK

Latch bolt by key outside and lever either side. Unless outside lever is locked by toggle-action stop.  
Dead bolt by key outside and turnpiece inside.  
Turning inside lever retracts latch and dead bolt simultaneously. Outside lever remains locked.  
Auxiliary latch deadlocks latch bolt and prevents manipulation of locked toggle action stop.

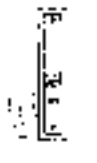

## ML-NC COMMUNICATING

Latch bolt by lever one side.



## ML-E OFFICE

Latch bolt by key outside and lever either side unless outside lever is locked by toggle-action stop.  
Auxiliary latch deadlocks latch bolt.

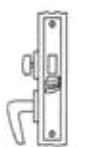

## ML-LFC COMMUNICATING

Latch bolt by lever inside only.  
Dead bolt by turnpiece inside only.  
A turn of inside lever retracts latch and dead bolt simultaneously-automatically unlocking door.



## ML-EW STOREROOM

Latch by lever inside and key outside.  
Outside lever is always rigid.  
Auxiliary latch deadlocks latch bolt.



## ML-H HOTEL

Latch bolt by lever inside and guest or master key outside. Outside lever always rigid.  
Dead bolt by turnpiece inside and key outside.  
A turn of inside lever retracts latch and dead bolt simultaneously. Auxiliary latch deadlocks latch bolt.

The narrow backset mortise locks are available only in the following functions:

ML-FW Entrance  
ML-F Entrance  
ML-N Passage  
ML-LF Privacy

ML-J Classroom  
ML-E Office  
ML-EW Storeroom

# Rosette options for mortise application

## 1. Keyed cylinder

RP Round Rosette with cylinder collar  
RPS Round Rosette Stainless steel with cylinder collar

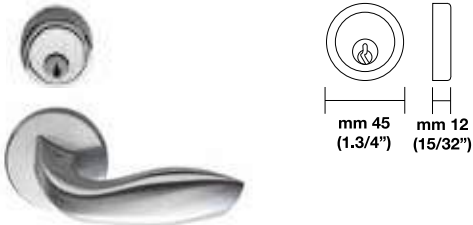

(shown w/ H 354 Door lever)

RQ Square Rosette with cylinder collar  
RQS Square Rosette Stainless steel with cylinder collar



(shown w/ H 356 Door lever)

## 2. Thumbturn interior/emergency release privacy (brass)

RP Round Rosette mm 65 (2.9/16")  
Thumbturn (Interior and emergency release)



(shown w/ H 326 Door lever)

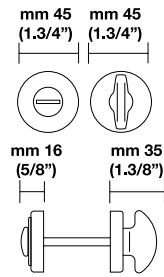

Interior and emergency release with indicator

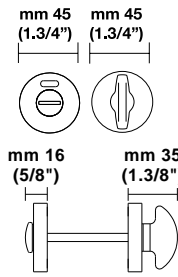

RQ Square Rosette mm 65 (2.9/16")  
Thumbturn (Interior and emergency release)



(shown w/ H 311 Door lever)

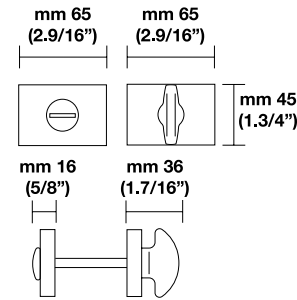

Interior and emergency release with indicator

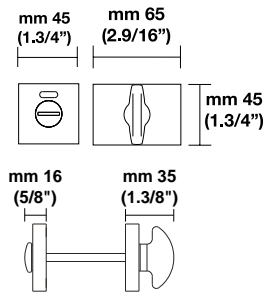

RT Traditional Rosette mm 65 (2.9/16")  
Thumbturn (Interior and emergency release)



(shown w/ V&V H 359 Door lever)

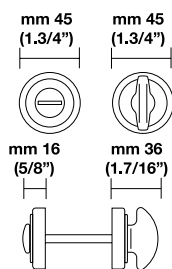

Conversions from metric to U.S. measurements are approximate.

The configurations above are considered standard with the exclusion of the emergency release with indicator, only available on special request. ADA compliant Thumbturn is available on special request. For its design check page 140. Call for pricing.

Other thumb turns are available as optional. Check page 140 for details.

# Rosette options for mortise application

## 3. Thumbturn interior/emergency release privacy (stainless steel)

RPS Round Rosette Stainless steel mm 65 (2.9/16")  
Thumbturn (Interior and emergency Release)



(shown w/ H 5015 Door lever)

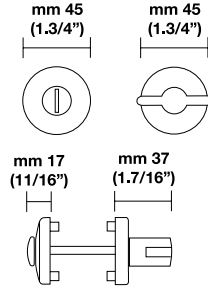

Interior and emergency release with indicator

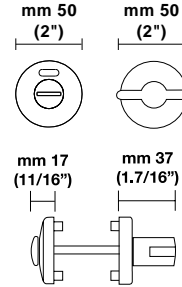

RQS Square Rosette Stainless steel mm 65 (2.9/16")  
Thumbturn (Interior and emergency Release)



(shown w/ H 5008 Door lever)

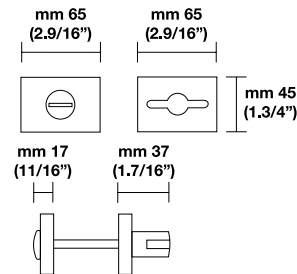

## Cylinder finish options

The cylinders are supplied in the finishes below, unless differently requested at the time of the order:

- Trim finish 03 = Cylinder finish 03 / POLISHED BRASS
- Trim finishes 03D, 03M = Cylinder in 03D / SATIN BRASS
- Trim finish 06 = Cylinder in 06 / ANTIQUE BRASS
- Trim finishes 06A, 06B, 06M, 10S, 56 = Cylinders in 10B / OIL RUBBED BRONZE
- Trim finish 14, 17A, 26, 32 = Cylinder in 26 / POLISHED CHROME
- Trim finish 15, 32D = Cylinder in 15 / SATIN NICKEL
- Trim finish 16 = Cylinder in 16 / DULL BLACK
- Trim finish 22M = Cylinder in 22M / MATT WHITE
- Trim finish 26D = Cylinder in 26D / SATIN CHROME

For the finishes of face and strike plates, check pages 20-21.

The configurations above are considered standard with the exclusion of the emergency release with indicator, only available on special request.  
ADA compliant Thumbturn is available on special request.  
For its design check page 140. Call for pricing.

# Escutcheon plate options

## 1. Keyed cylinder

ER/ERS Rectangular Escutcheon



(shown w/ H 311 Door lever)

ET Traditional Escutcheon



(shown w/ V&V H 179 Door lever)

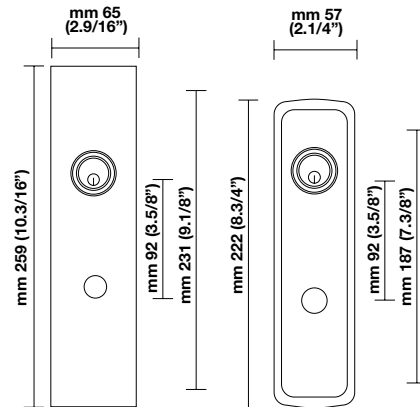

EP Oval Escutcheon



(shown w/ Fusital H 38 Door lever)

NES Narrow Oval Escutcheon Stainless steel



(shown w/ H 5004 Door lever)

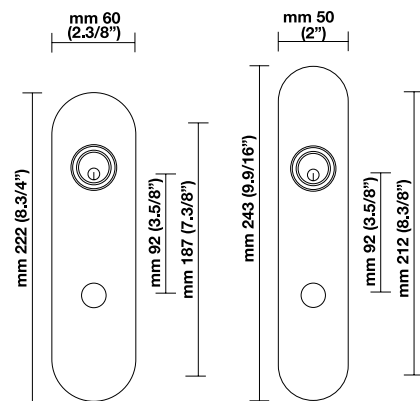

## 2. Thumbturn interior/emergency release privacy (brass and stainless steel)

Thumbturn (Interior)  
ER/ERS Rectangular Escutcheon



(shown w/ H 311 Door lever)

Stainless steel  
NES Narrow Oval Escutcheon



(shown w/ H 5004 Door lever)

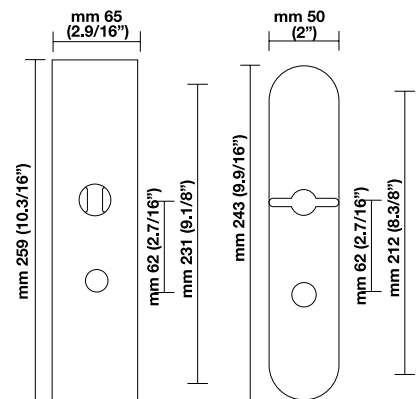

Conversions from metric to U.S. measurements are approximate.

The configurations above are considered standard.  
Need to specify handing on escutcheon plates.  
Call for any special requests.

# Fusital Group I - Mortise Locks



## DOOR LEVERS

H315, H317, H326, H327, H330, H334, H338, H348, H361, H364, H367, H368, H370, H372, H381, H382, H383

### Retail Price

	RP/RT	RQ	RS	EP/ET	ER	RQ/K1225
ML F/Entrance	\$ 1.018.00	\$ 1.146.00	\$ 912.00	\$ 960.00	\$ 995.00	\$ 1.170.00
ML FD/Entrance	\$ 1.065.00	\$ 1.193.00	\$ 960.00	\$ 1.006.00	\$ 1.041.00	-
ML FW/Entrance	\$ 995.00	\$ 1.123.00	\$ 865.00	\$ 925.00	\$ 971.00	-
ML B/Entrance	\$ 995.00	\$ 1.123.00	\$ 878.00	\$ 925.00	\$ 971.00	-
ML AC/Entrance	\$ 995.00	\$ 1.100.00	\$ 889.00	\$ 971.00	\$ 1.006.00	-
ML E/Office	\$ 960.00	\$ 1.041.00	\$ 855.00	\$ 960.00	\$ 971.00	-
ML EW/Storeroom	\$ 925.00	\$ 995.00	\$ 808.00	\$ 925.00	\$ 971.00	-
ML J/Classroom	\$ 960.00	\$ 1.041.00	\$ 855.00	\$ 971.00	\$ 1.006.00	-
ML N/Passage	\$ 808.00	\$ 842.00	\$ 691.00	\$ 832.00	\$ 865.00	-
ML LF/Privacy	\$ 1.018.00	\$ 1.158.00	\$ 912.00	\$ 912.00	\$ 960.00	-
ML H/Hotel	-	-	-	\$ 901.00	\$ 995.00	-
ML NC/Communicating	\$ 562.00	\$ 574.00	\$ 574.00	\$ 644.00	\$ 667.00	-
ML ELEC/Electrified	\$ 2.151.00	\$ 2.245.00	\$ 2.046.00	\$ 2.151.00	\$ 2.198.00	-

**Note:** RS/Small rosettes not recommended for commercial use

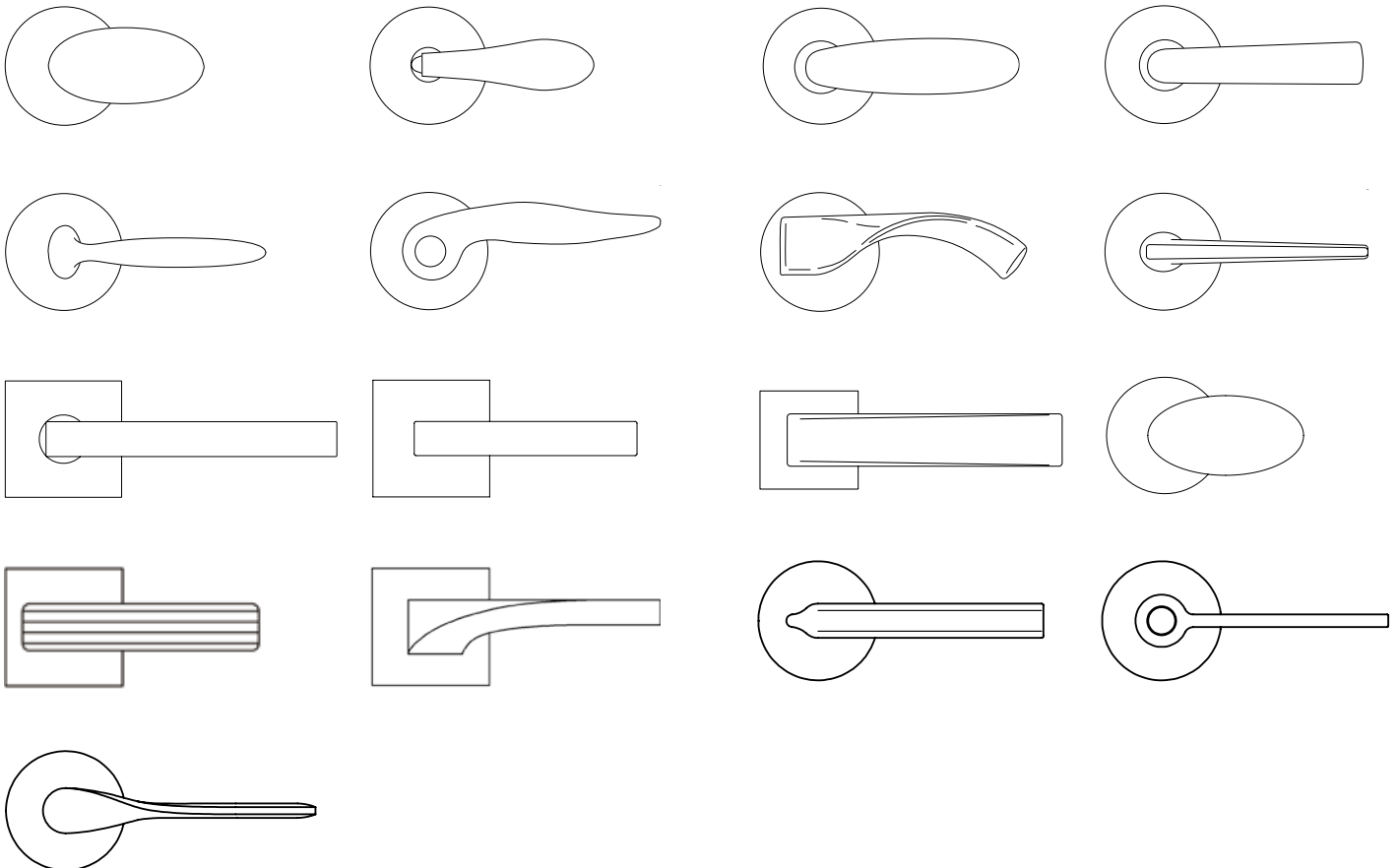

The prices above refer to locks of 2.3/4" and 2.1/2" backset. Upcharges apply for different backsets. See page 15.

If requested without mortise lock, deduct **\$120** retail price. For ML-ELECT without mortise lock, deduct **\$120** from ML-EW retail price.

If requested without cylinder, deduct **\$15** retail price.

Same prices for all the standard finishes as indicated per each lever page. Special finishes are available upon request. See pages 20-21 for finish selection. Upcharges apply.

Upside Down and Magnetic Locks are available upon request. Upcharges at page 15.

For the electrified mortise locks, the AE switch (Request to Exit) must be requested at the time of the order. Upcharges apply.



# Fusital Group II - Mortise Locks



**DOOR LEVERS** H311, H329, H335, H343, H359, H369, H376, H378, H384  
**DOOR KNOBS** K378, K383

### Retail Price

	RP/RT	RQ	RS	EP/ET	ER	RQ/K1225
ML F/Entrance	\$ 1,123.00	\$ 1,286.00	\$ 1,041.00	\$ 1,076.00	\$ 1,111.00	\$ 1,403.00
ML FD/Entrance	\$ 1,193.00	\$ 1,322.00	\$ 1,088.00	\$ 1,135.00	\$ 1,170.00	-
ML FW/Entrance	\$ 1,111.00	\$ 1,252.00	\$ 995.00	\$ 1,053.00	\$ 1,100.00	-
ML B/Entrance	\$ 1,123.00	\$ 1,252.00	\$ 1,006.00	\$ 1,041.00	\$ 1,088.00	-
ML AC/Entrance	\$ 1,111.00	\$ 1,216.00	\$ 1,030.00	\$ 1,100.00	\$ 1,135.00	-
ML E/Office	\$ 1,088.00	\$ 1,158.00	\$ 983.00	\$ 1,088.00	\$ 1,135.00	-
ML EW/Storeroom	\$ 1,053.00	\$ 1,123.00	\$ 935.00	\$ 1,041.00	\$ 1,088.00	-
ML J/Classroom	\$ 1,088.00	\$ 1,158.00	\$ 983.00	\$ 1,088.00	\$ 1,135.00	-
ML N/Passage	\$ 935.00	\$ 960.00	\$ 819.00	\$ 960.00	\$ 995.00	-
ML LF/Privacy	\$ 1,135.00	\$ 1,286.00	\$ 1,030.00	\$ 1,030.00	\$ 1,076.00	-
ML H/Hotel	-	-	-	\$ 1,018.00	\$ 1,100.00	-
ML NC/Communicating	\$ 621.00	\$ 632.00	\$ 632.00	\$ 702.00	\$ 715.00	-
ML ELEC/Electrified	\$ 2,281.00	\$ 2,385.00	\$ 2,164.00	\$ 2,268.00	\$ 2,314.00	-

**Note:** RS/Small rosettes not recommended for commercial use

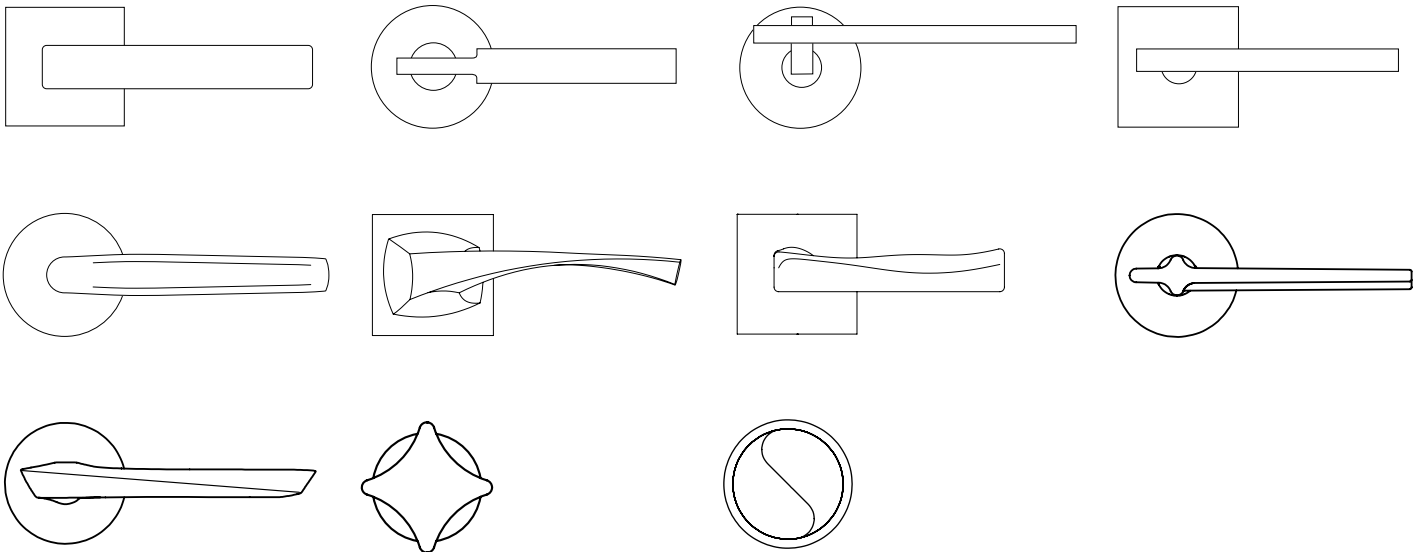

The prices above refer to locks of 2.3/4" and 2.1/2" backset. Upcharges apply for different backsets. See page 15.

If requested without mortise lock, deduct **\$120** retail price. For ML-ELECT without mortise lock, deduct **\$120** from ML-EW retail price.

If requested without cylinder, deduct **\$15** retail price.

Same prices for all the standard finishes as indicated per each lever page. Special finishes are available upon request. See pages 20-21 for finish selection. Upcharges apply.

Upside Down and Magnetic Locks are available upon request. Upcharges at page 15.

For the electrified mortise locks, the AE switch (Request to Exit) must be requested at the time of the order. Upcharges apply.

# Fusital Group III - Mortise Locks

**DOOR LEVERS** H350, H377  
**DOOR KNOBS** K377

### Retail Price

	RP/RT	RQ	RS	EP/ET	ER	RQ/K1225
ML F/Entrance	\$ 1,497.00	\$ 1,625.00	\$ 1,392.00	\$ 1,439.00	\$ 1,474.00	\$ 1,660.00
ML FD/Entrance	\$ 1,544.00	\$ 1,673.00	\$ 1,439.00	\$ 1,486.00	\$ 1,521.00	-
ML FW/Entrance	\$ 1,462.00	\$ 1,625.00	\$ 1,346.00	\$ 1,403.00	\$ 1,451.00	-
ML B/Entrance	\$ 1,462.00	\$ 1,614.00	\$ 1,356.00	\$ 1,392.00	\$ 1,451.00	-
ML AC/Entrance	\$ 1,474.00	\$ 1,567.00	\$ 1,356.00	\$ 1,451.00	\$ 1,486.00	-
ML E/Office	\$ 1,451.00	\$ 1,521.00	\$ 1,333.00	\$ 1,439.00	\$ 1,486.00	-
ML EW/Storeroom	\$ 1,403.00	\$ 1,474.00	\$ 1,286.00	\$ 1,403.00	\$ 1,451.00	-
ML J/Classroom	\$ 1,451.00	\$ 1,521.00	\$ 1,333.00	\$ 1,439.00	\$ 1,486.00	-
ML N/Passage	\$ 1,299.00	\$ 1,322.00	\$ 1,170.00	\$ 1,310.00	\$ 1,356.00	-
ML LF/Privacy	\$ 1,497.00	\$ 1,544.00	\$ 1,392.00	\$ 1,392.00	\$ 1,439.00	-
ML H/Hotel	-	-	-	\$ 1,380.00	\$ 1,462.00	-
ML NC/Communicating	\$ 795.00	\$ 808.00	\$ 808.00	\$ 878.00	\$ 889.00	-
ML ELEC/Electrified	\$ 2,632.00	\$ 2,701.00	\$ 2,525.00	\$ 2,631.00	\$ 2,689.00	-

**Note:** RS/Small rosettes not recommended for commercial use

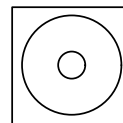
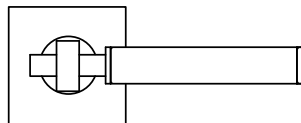
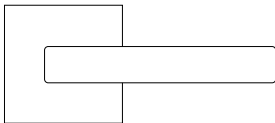

The prices above refer to locks of 2.3/4" and 2.1/2" backset. Upcharges apply for different backsets. See page 15.

If requested without mortise lock, deduct **\$120** retail price. For ML-ELECT without mortise lock, deduct **\$120** from ML-EW retail price.

If requested without cylinder, deduct **\$15** retail price.

Same prices for all the standard finishes as indicated per each lever page. Special finishes are available upon request. See pages 20-21 for finish selection. Upcharges apply.

Upside Down and Magnetic Locks are available upon request. Upcharges at page 15.

For the electrified mortise locks, the AE switch (Request to Exit) must be requested at the time of the order. Upcharges apply.

# Fusital Group IV - Mortise Locks



## DOOR LEVERS H354, H356, H379, H380

	Retail Price					
	RP/RT	RQ	RS	EP/ET	ER	RQ/K1225
ML F/Entrance	\$ 1,544.00	\$ 1,684.00	\$ 1,462.00	\$ 1,497.00	\$ 1,532.00	\$ 1,696.00
ML FD/Entrance	\$ 1,614.00	\$ 1,730.00	\$ 1,497.00	\$ 1,544.00	\$ 1,579.00	-
ML FW/Entrance	\$ 1,521.00	\$ 1,660.00	\$ 1,403.00	\$ 1,474.00	\$ 1,509.00	-
ML B/Entrance	\$ 1,521.00	\$ 1,660.00	\$ 1,427.00	\$ 1,474.00	\$ 1,509.00	-
ML AC/Entrance	\$ 1,544.00	\$ 1,660.00	\$ 1,451.00	\$ 1,532.00	\$ 1,579.00	-
ML E/Office	\$ 1,497.00	\$ 1,579.00	\$ 1,229.00	\$ 1,497.00	\$ 1,521.00	-
ML EW/Storeroom	\$ 1,474.00	\$ 1,544.00	\$ 1,263.00	\$ 1,462.00	\$ 1,509.00	-
ML J/Classroom	\$ 1,497.00	\$ 1,579.00	\$ 1,229.00	\$ 1,497.00	\$ 1,544.00	-
ML N/Passage	\$ 1,346.00	\$ 1,497.00	\$ 1,229.00	\$ 1,369.00	\$ 1,403.00	-
ML LF/Privacy	\$ 1,567.00	\$ 1,684.00	\$ 1,451.00	\$ 1,451.00	\$ 1,486.00	-
ML H/Hotel	-	-	-	\$ 1,427.00	\$ 1,521.00	-
ML NC/Communicating	\$ 832.00	\$ 835.00	\$ 842.00	\$ 912.00	\$ 925.00	-
ML ELEC/Electrified	\$ 2,701.00	\$ 2,805.00	\$ 2,572.00	\$ 2,689.00	\$ 2,748.00	-

**Note:** RS/Small rosettes not recommended for commercial use

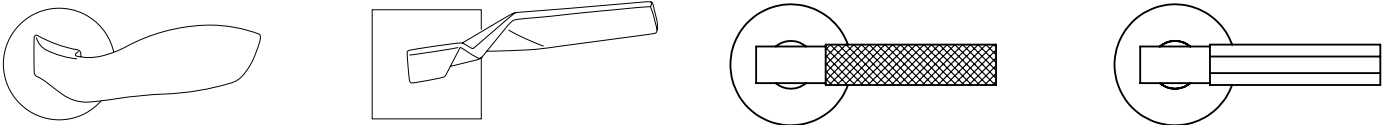

The prices above refer to locks of 2.3/4" and 2.1/2" backset. Upcharges apply for different backsets. See page 15.

If requested without mortise lock, deduct **\$120** retail price. For ML-ELECT without mortise lock, deduct **\$120** from ML-EW retail price.

If requested without cylinder, deduct **\$15** retail price.

Same prices for all the standard finishes as indicated per each lever page. Special finishes are available upon request. See pages 20-21 for finish selection. Upcharges apply.

Upside Down and Magnetic Locks are available upon request. Upcharges at page 15.

For the electrified mortise locks, the AE switch (Request to Exit) must be requested at the time of the order. Upcharges apply.



# Fusital Inox Group III/Group IV - Mortise Locks



## GROUP III                      H5015 black leather, H5015 orange leather

	Retail Price				
	RPS	RQS	RSS	NES	ERS
ML F/Entrance	\$ 2,128.00	\$ 2,281.00	\$ 1,860.00	\$ 1,906.00	\$ 1,945.00
ML FD/Entrance	\$ 2,175.00	\$ 2,281.00	\$ 1,906.00	\$ 1,953.00	\$ 1,988.00
ML FW/Entrance	\$ 2,093.00	\$ 2,105.00	\$ 1,836.00	\$ 1,895.00	\$ 1,930.00
ML B/Entrance	\$ 2,081.00	\$ 2,105.00	\$ 1,847.00	\$ 1,895.00	\$ 1,930.00
ML AC/Entrance	\$ 2,046.00	\$ 2,105.00	\$ 1,790.00	\$ 1,930.00	\$ 2,011.00
ML E/Office	\$ 1,965.00	\$ 2,046.00	\$ 1,707.00	\$ 1,860.00	\$ 1,953.00
ML EW/Storeroom	\$ 1,930.00	\$ 1,988.00	\$ 1,673.00	\$ 1,824.00	\$ 1,906.00
ML J/Classroom	\$ 1,965.00	\$ 2,046.00	\$ 1,707.00	\$ 1,860.00	\$ 1,953.00
ML N/Passage	\$ 1,754.00	\$ 1,813.00	\$ 1,497.00	\$ 1,696.00	\$ 1,790.00
ML LF/Privacy	\$ 2,105.00	\$ 2,095.00	\$ 1,847.00	\$ 1,813.00	\$ 1,870.00
ML H/Hotel	-	-	-	\$ 1,941.00	\$ 1,876.00
ML NC/Communicating	\$ 1,053.00	\$ 1,111.00	\$ 1,030.00	\$ 1,053.00	\$ 1,123.00
ML ELEC/Electrified	\$ 3,156.00	\$ 3,273.00	\$ 2,900.00	\$ 3,040.00	\$ 3,133.00

**Note:** RSS/Small rosettes not recommended for commercial use

## GROUP IV                      H5014

	Retail Price				
	RPS	RQS	RSS	NES	ERS
ML F/Entrance	\$ 1,216.00	\$ 1,240.00	\$ 971.00	\$ 1,018.00	\$ 1,041.00
ML FD/Entrance	\$ 1,252.00	\$ 1,286.00	\$ 1,018.00	\$ 1,065.00	\$ 1,100.00
ML FW/Entrance	\$ 1,170.00	\$ 1,216.00	\$ 935.00	\$ 995.00	\$ 1,018.00
ML B/Entrance	\$ 1,170.00	\$ 1,216.00	\$ 935.00	\$ 983.00	\$ 995.00
ML AC/Entrance	\$ 1,158.00	\$ 1,229.00	\$ 889.00	\$ 1,030.00	\$ 1,088.00
ML E/Office	\$ 1,053.00	\$ 1,065.00	\$ 819.00	\$ 971.00	\$ 1,053.00
ML EW/Storeroom	\$ 1,018.00	\$ 1,030.00	\$ 772.00	\$ 925.00	\$ 1,006.00
ML J/Classroom	\$ 1,053.00	\$ 1,065.00	\$ 819.00	\$ 971.00	\$ 1,053.00
ML N/Passage	\$ 842.00	\$ 878.00	\$ 597.00	\$ 795.00	\$ 889.00
ML LF/Privacy	\$ 1,206.00	\$ 1,240.00	\$ 960.00	\$ 925.00	\$ 971.00
ML H/Hotel	-	-	-	\$ 1,030.00	\$ 1,065.00
ML NC/Communicating	\$ 609.00	\$ 632.00	\$ 586.00	\$ 609.00	\$ 679.00
ML ELEC/Electrified	\$ 2,245.00	\$ 2,397.00	\$ 2,011.00	\$ 2,151.00	\$ 2,245.00

**Note:** RSS/Small rosettes not recommended for commercial use

The prices above refer to locks of 2.3/4" and 2.1/2" backset. Upcharges apply for different backsets. See page 15.

If requested without mortise lock, deduct **\$120** retail price. For ML-ELECT without mortise lock, deduct **\$120** from ML-EW retail price.

If requested without cylinder, deduct **\$15** retail price.

Same prices for all the standard finishes as indicated per each lever page. Special finishes are available upon request. See pages 20-21 for finish selection. Upcharges apply.

Upside Down and Magnetic Locks are available upon request. Upcharges at page 15.

For the electrified mortise locks, the AE switch (Request to Exit) must be requested at the time of the order. Upcharges apply.







deadlock

# Deadlock

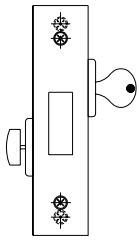

1.1/4  
Cylinder  
Outside Only

5/8  
Turn Piece  
Inside Only

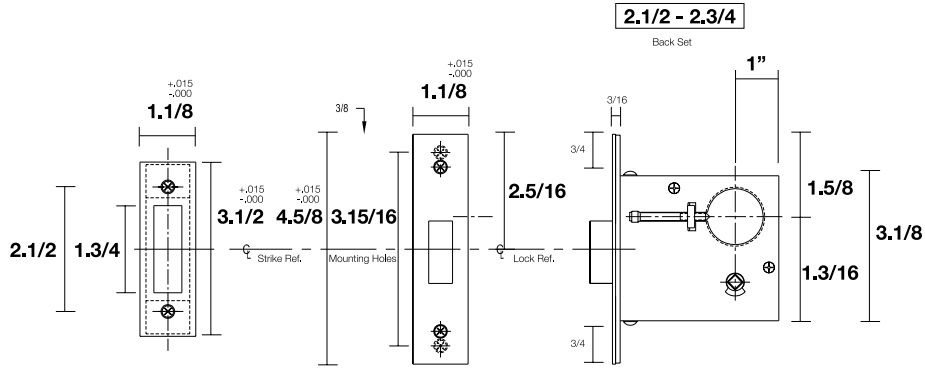

## ML - Deadlock Retail Price

Trim finish	03	03D/03M	14	15	16	26	26D	32	32D
RP	\$ 361.00	\$ 361.00	\$ 396.00	\$ 396.00	\$ 361.00	\$ 361.00	\$ 391.00	-	-
RPS	-	-	-	-	-	-	-	\$ 566.00	\$ 517.00
RQ	\$ 467.00	\$ 467.00	\$ 511.00	\$ 511.00	\$ 467.00	\$ 467.00	\$ 497.00	-	-
RQS	-	-	-	-	-	-	-	\$ 720.00	\$ 671.00

The finishes above are considered standard.  
Different finishes are available upon special request.  
See pages 20-21 for different finish options and page 15 for pricing.

Available in 2.3/4" and 2.1/2" for the same price.  
The backset needs to be specified by the time of the order.  
Cylinders are not included and priced apart.



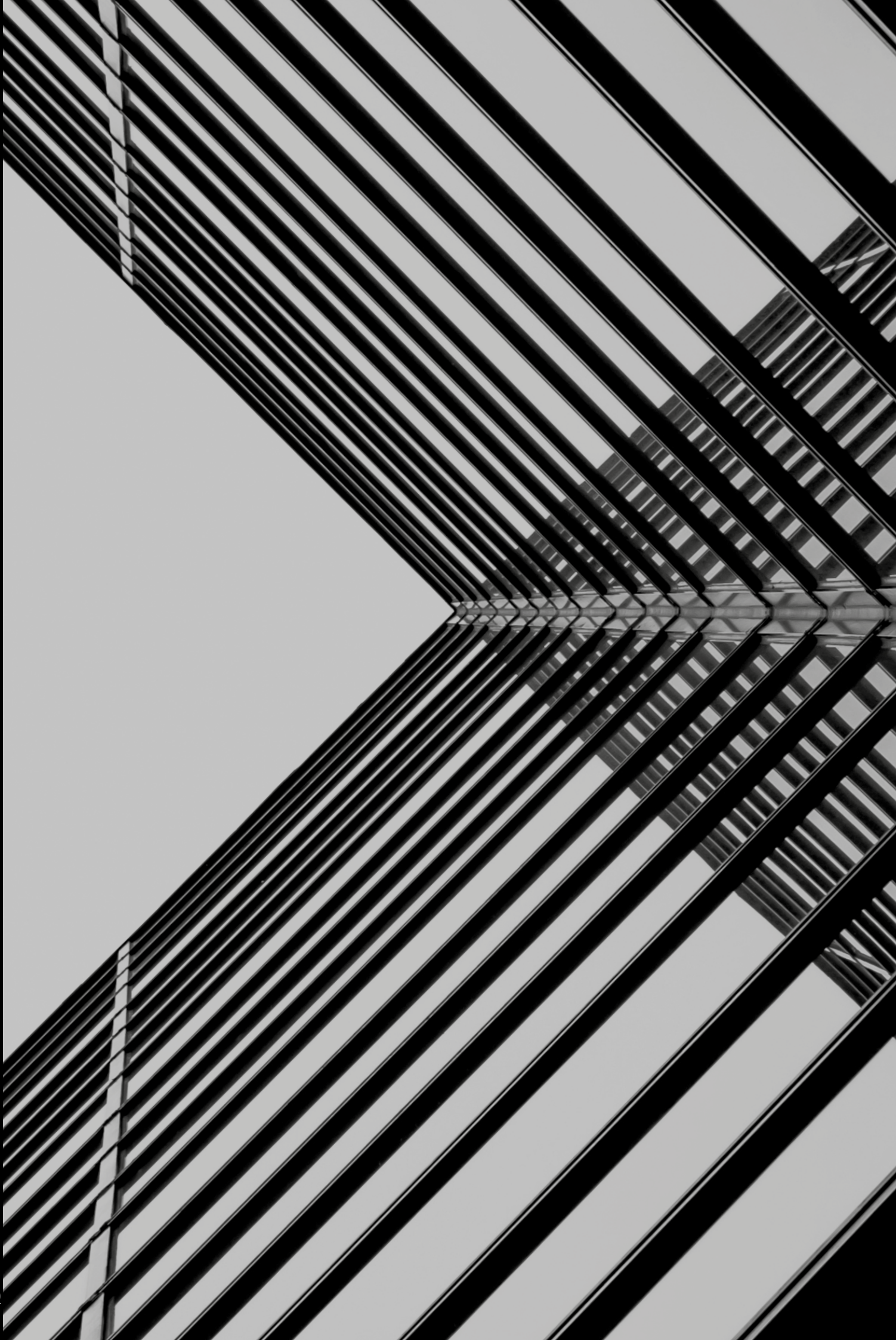



# deadbots

## 1. 101 Single cylinder

### Solid Brass Version

	101 RP Round	101 RT Traditional	101 RQ Square	101 RQ / K1225 (Rectangular shaped thumb turn)
INTERIOR				
EXTERIOR				
		RP/RT	RQ	RQ/K1225

### Stainless Steel Version

	101 RPS Round	101 RQS Square				
INTERIOR						
EXTERIOR						

## 2. 102 Double cylinder

Conversions from metric to U.S. measurements are approximate.

# Deadbolts

Material: Solid brass, stainless steel 316 L



## 101 SINGLE CYLINDER DEADBOLT

### Retail Price

Finish	RT	RP	RQ	RPS	RQS
03	-	\$ 320.00	\$ 425.00	-	-
03D	-	\$ 325.00	-	-	-
03/03D	\$ 290.00	-	-	-	-
03M	-	\$ 322.00	\$ 427.00	-	-
06	\$ 299.00	-	-	-	-
06A	\$ 317.00	\$ 330.00	-	-	-
06B	\$ 302.00	\$ 312.00	\$ 425.00	-	-
06M	-	\$ 340.00	\$ 450.00	-	-
10S	-	\$ 340.00	\$ 450.00	-	-
14	\$ 318.00	\$ 319.00	\$ 431.00	-	-
15	\$ 314.00	\$ 318.00	\$ 437.00	-	-
16	-	\$ 302.00	\$ 391.00	-	-
17A	-	\$ 340.00	\$ 449.00	-	-
22M	-	\$ 313.00	\$ 403.00	-	-
26	-	\$ 306.00	\$ 408.00	-	-
26D	-	\$ 307.00	\$ 427.00	-	-
26/26D	\$ 301.00	-	-	-	-
32	-	-	-	\$ 596.00	\$ 618.00
32D	-	-	-	\$ 498.00	\$ 508.00
56	-	\$ 339.00	\$ 449.00	-	-
R1	-	\$ 596.00	-	-	-
R2	-	\$ 498.00	-	-	-

### Note:

Cylinder finishes are supplied as below, unless differently requested at the time of the order:

Trim finish 03 = Cylinder finish 03 / POLISHED BRASS

Trim finishes 03D, 03M = Cylinder in 03D / SATIN BRASS

Trim finish 06 = Cylinder in 06 / ANTIQUE BRASS

Trim finishes 06A, 06B, 06M, 10S, 56 = Cylinders in 10B / OIL RUBBED BRONZE

Trim finish 14, 17A, 26, 32 = Cylinder in 26 / POLISHED CHROME

Trim finish 15, 32D = Cylinder in 15 / SATIN NICKEL

Trim finish 16 = Cylinder in 16 / DULL BLACK

Trim finish 22M = Cylinder in 22M / MATT WHITE

Trim finish 26D = Cylinder in 26D / SATIN CHROME

The finishes above are considered standard.

For different finish options see pages 20-21 and pricing at page 15.

The 101 deadbolt can be ordered less exterior trim

For pricing, remove **\$150.00** from the listed prices above for 32 and 32D finish, and **\$75.00** for all the other finishes.

Specify "Less Exterior - L/E" as a note to the order.

For the pricing of the 101 RQ/K1225, consider the same price of the 101 RQ and specify as a note to the order "with K1225 thumbturn".

# Deadbolts

Material: Solid brass, stainless steel 316 L



## 102 DOUBLE CYLINDER DEADBOLT

### Retail Price

Finish	RT	RP	RQ	RPS	RQS
03	-	\$ 309.00	\$ 404.00	-	-
03D	-	\$ 317.00	-	-	-
03/03D	\$ 304.00	-	-	-	-
03M	-	\$ 335.00	\$ 410.00	-	-
06	\$ 291.00	-	-	-	-
06A	\$ 302.00	\$ 324.00	-	-	-
06B	\$ 324.00	\$ 341.00	\$ 434.00	-	-
06M	-	\$ 341.00	\$ 434.00	-	-
10S	-	\$ 341.00	\$ 434.00	-	-
14	\$ 326.00	\$ 335.00	\$ 410.00	-	-
15	\$ 335.00	\$ 342.00	\$ 434.00	-	-
16	-	\$ 309.00	\$ 404.00	-	-
17A	-	\$ 341.00	\$ 434.00	-	-
22M	-	\$ 316.00	\$ 410.00	-	-
26	-	\$ 324.00	\$ 390.00	-	-
26D	-	\$ 320.00	\$ 410.00	-	-
26/26D	\$ 305.00	-	-	-	-
32	-	-	-	\$ 576.00	\$ 621.00
32D	-	-	-	\$ 498.00	\$ 534.00
56	-	\$ 341.00	\$ 434.00	-	-
R1	-	\$ 576.00	-	-	-
R2	-	\$ 498.00	-	-	-

### Note:

Cylinder finishes are supplied as below, unless differently requested at the time of the order:

Trim finish 03 = Cylinder finish 03 / POLISHED BRASS

Trim finishes 03D, 03M = Cylinder in 03D / SATIN BRASS

Trim finish 06 = Cylinder in 06 / ANTIQUE BRASS

Trim finishes 06A, 06B, 06M, 10S, 56 = Cylinders in 10B / OIL RUBBED BRONZE

Trim finish 14, 17A, 26, 32 = Cylinder in 26 / POLISHED CHROME

Trim finish 15, 32D = Cylinder in 15 / SATIN NICKEL

Trim finish 16 = Cylinder in 16 / DULL BLACK

Trim finish 22M = Cylinder in 22M / MATT WHITE

Trim finish 26D = Cylinder in 26D / SATIN CHROME

The finishes above are considered standard.  
For different finish options see pages 20-21 and pricing at page 15.







The background is a complex geometric pattern of black and white lines. A large, dark grey 'A' shape is formed by the negative space of the lines. The lines themselves are of varying thickness and orientation, creating a sense of depth and perspective. The overall effect is a high-contrast, abstract architectural or digital design.

privacy  
boots

## 1. 105 Privacy bolt

### Solid Brass Version

	105 RSP Round	105 RST Traditional	105 RSQ Square	105 RSQ / K1225 (Rectangular shaped thumb turn)
INTERIOR				
EXTERIOR				
		RSP/RST	RSQ	RSQ/K1225 (A)      RSQ/K1225 (B)

### Stainless Steel Version

	105 RSS Round	105 RSQS Square		
INTERIOR				
EXTERIOR				
			RSS	RSQS

## 2. 107 ADA Privacy bolt

	107 RPS Round	107 RQS Square		
INTERIOR				
EXTERIOR				
			RSP	RSQ

Conversions from metric to U.S. measurements are approximate.

# Privacy Bolts

Material: Solid brass, stainless steel 316 L



## 105 PRIVACY BOLTS

### Retail Price

Finish	RST	RSP	RSQ	RSQ/K1225	RSS	RSQS
03	\$ 280.00	\$ 251.00	\$ 364.00	\$ 366.00	-	-
03D	-	\$ 251.00	-	-	-	-
03/03D	\$ 276.00	-	-	-	-	-
03M	-	\$ 287.00	\$ 391.00	\$ 403.00	-	-
06	\$ 319.00	-	-	-	-	-
06A	\$ 338.00	\$ 280.00	-	-	-	-
06B	-	\$ 267.00	\$ 411.00	\$ 411.00	-	-
06M	-	\$ 307.00	\$ 411.00	\$ 436.00	-	-
10S	-	\$ 307.00	\$ 411.00	\$ 436.00	-	-
14	\$ 315.00	\$ 302.00	\$ 436.00	\$ 436.00	-	-
15	\$ 300.00	\$ 287.00	\$ 398.00	\$ 398.00	-	-
16	-	\$ 259.00	\$ 365.00	\$ 373.00	-	-
17A	-	\$ 307.00	\$ 411.00	\$ 436.00	-	-
22M	-	\$ 307.00	\$ 365.00	\$ 436.00	-	-
26	-	\$ 255.00	\$ 367.00	\$ 348.00	-	-
26D	-	\$ 287.00	\$ 398.00	\$ 398.00	-	-
26/26D	\$ 334.00	-	-	-	-	-
32	-	-	-	-	\$ 278.00	\$ 525.00
32D	-	-	-	-	\$ 252.00	\$ 422.00
56	-	\$ 307.00	\$ 411.00	\$ 436.00	-	-
R1	-	\$ 278.00	-	-	-	-
R2	-	\$ 252.00	-	-	-	-

The finishes above are considered standard.  
 For different finish options see pages 20-21 and pricing at page 15.  
 The 105 privacy bolt can be ordered less exterior trim.  
 For pricing, remove **\$100.00** from the listed prices above for 32 and 32D finish, and **\$50.00** for all the other finishes.  
 Specify "Less Exterior - L/E" as a note to the order.

For the ADA compliant Privacy bolt, call for pricing.  
 For the privacy bolt with slim rosettes consider the same price of RSP (round) and RSQ (square).

The 105 RSQ / K1225 (A) 2.9/16"x1.3/4", and the 105 RSQ / K1225 (B) 2"x2" have the same prices.

## 1. Standard Thumb turns for Deadlocks, Deadbolts, Privacy bolts and Mortise locks

**K1725 (Half moon) - Brass**

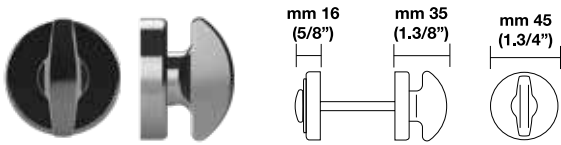

**S5501 (Butterfly) - Stainless steel**

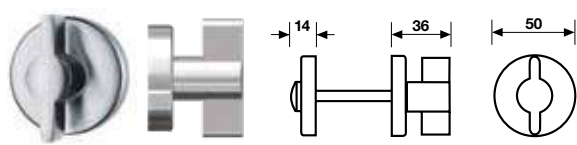

## 2. Optional Thumb turns for Deadlocks, Deadbolts, Privacy bolts and Mortise locks

**K1225 (Square) - Brass**

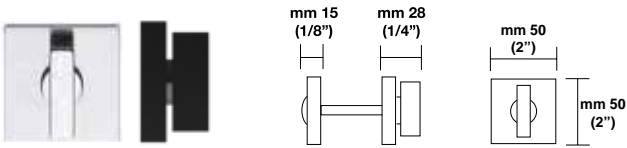

**K1704 (Euro design) - Brass**

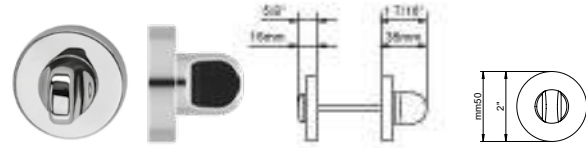

**K1811 (ADA) - Brass**

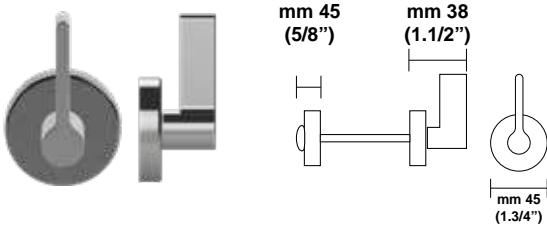

**K1867 (Rose) - Pure copper (Standard for H1067)**

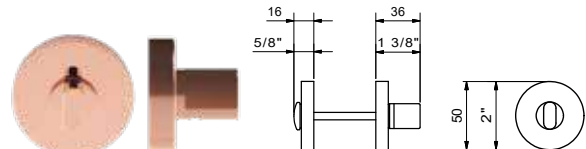

**K3040 (KAN) - Brass**

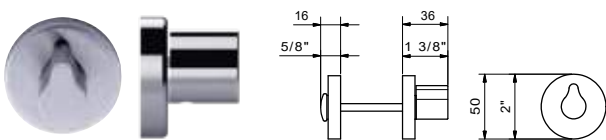

**K3041 (CCD) - Brass**

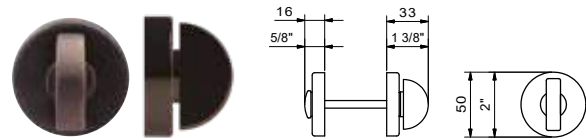

**\*\* K1705 CUSTOM - Brass**

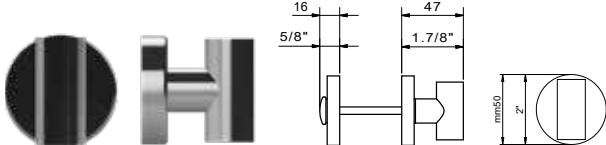

**\*\* K1818 CUSTOM - Brass**

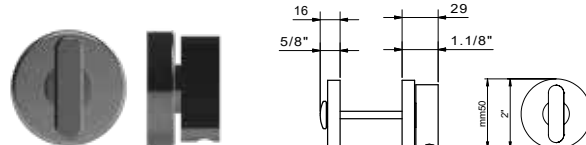

### Emergency release with occupancy indicator

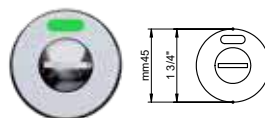

The thumb turns shown in this page can be matched with either round or square rosettes, oval or rectangular plates. In brackets are the names of the series. The K1725 is provided standard on all the applications for brass material levers. The S5501 is standard for stainless steel levers.

The remaining thumb turns are provided only on request. Call for pricing.

The thumb turns with (\*\*) are only available on a Minimum order quantity. Call for details.

The brass material thumb turns can be produced in any finish. See pages 20-21 for finish options.

Stainless steel thumb turn are only produced in 32/Polished stainless steel and 32D/Satin stainless steel.







# escutcheon with deadbolts

## ER - 103 Rectangular Escutcheon (shown w/ H 311 door lever)

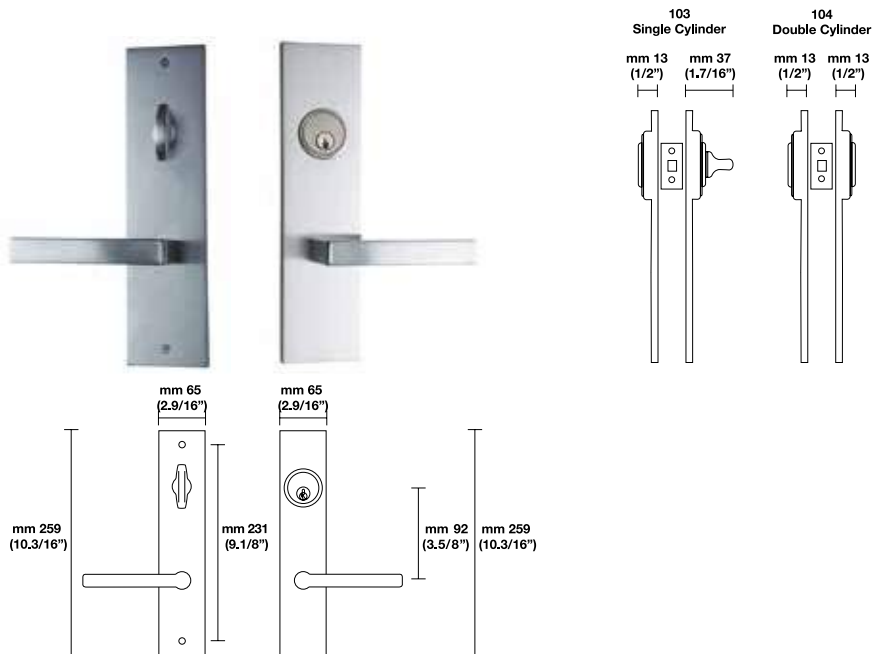

# Fusital Inox/Escutcheon with deadbolts

Material: Stainless steel AISI 316 L

## ERS - 103 Rectangular Escutcheon Stainless steel (shown w/ H 5004 door lever)

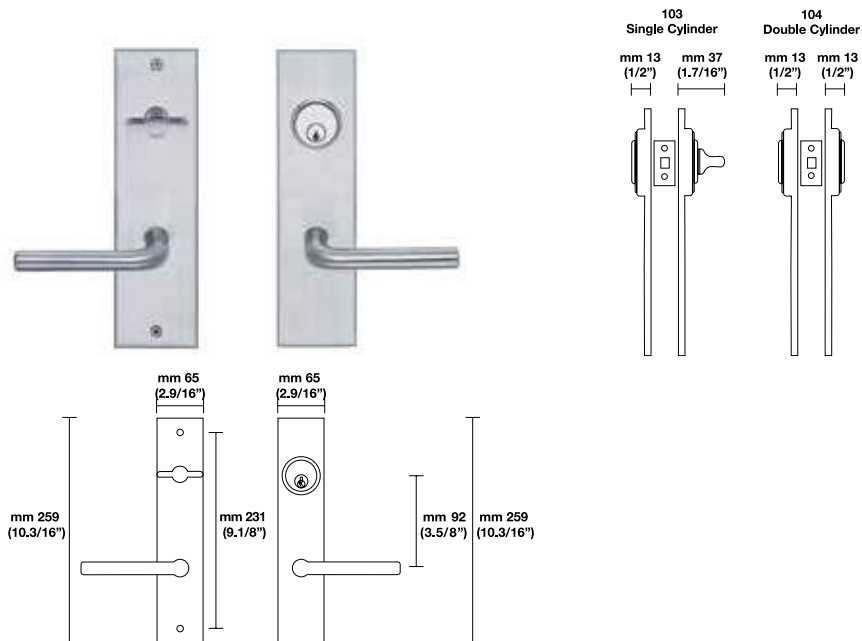

Different configurations available:  
**103** Escutcheon Single Cylinder  
**104** Escutcheon Double Cylinder  
**106** Escutcheon Privacy Bolt

# Fusital/Escutcheon with deadbolts



Material: Solid brass

## GROUP I

H315, H317, H326, H327, H330, H334, H338, H348, H361, H364, H367, H368, H370, H372, H381, H382, H383

Finish	Retail Price 103	104	106
EP/ET	\$ 819.00	\$ 795.00	\$ 738.00
ER	\$ 855.00	\$ 842.00	\$ 795.00

## GROUP II

H311, H329, H335, H343, H359, H369, H376, H378, H384, K378, K383

Finish	Retail Price 103	104	106
EP/ET	\$ 925.00	\$ 912.00	\$ 865.00
ER	\$ 960.00	\$ 948.00	\$ 912.00

## GROUP III

H350, H377, K377

Finish	Retail Price 103	104	106
EP/ET	\$ 1,263.00	\$ 1,252.00	\$ 1,206.00
ER	\$ 1,310.00	\$ 1,286.00	\$ 1,252.00

## GROUP IV

H354, H356, H379, H380

Finish	Retail Price 103	104	106
EP/ET	\$ 1,346.00	\$ 1,333.00	\$ 1,286.00
ER	\$ 1,403.00	\$ 1,392.00	\$ 1,356.00

Specify one of the below:  
**103** Escutcheon Single Cylinder  
**104** Escutcheon Double Cylinder  
**106** Escutcheon Privacy Bolt

EP/ET = standard finish 26 - 26D  
 ER = standard finish 26 - 26D  
 Special finishes available on request. For different finish options see pages 20-21 and pricing at page 15.

# Fusital Inox/Escutcheon with deadbolts



Material: Stainless steel AISI 316 L

## GROUP I

H5008, K5301, K5302

Finish	Retail Price	103	104	106
ERS		\$ 1,076.00	\$ 1,100.00	\$ 960.00

## GROUP II

H5015/32D, H5017

Finish	Retail Price	103	104	106
ERS		\$ 1,403.00	\$ 1,462.00	\$ 1,286.00

## GROUP III

H5015 black leather, H5015 orange leather

Finish	Retail Price	103	104	106
ERS		\$ 1,790.00	\$ 1,813.00	\$ 1,637.00

## GROUP IV

H5014

Finish	Retail Price	103	104	106
ERS		\$ 855.00	\$ 889.00	\$ 738.00

Specify one of the below:  
**103** Escutcheon Single Cylinder  
**104** Escutcheon Double Cylinder  
**106** Escutcheon Privacy Bolt

ERS = available only in 32D finish  
 Finish 32 = Polished Stainless Steel available on request for an upcharge. Call for pricing







# multi-point trim



Valli&Valli provides different configurations of Multi-Point trim.  
In order to select the right configuration you should identify the following:

## 1. The name of the manufacturer of the door and of the multi-point lock

Each manufacturer uses different templates for door drilling and different configurations are needed according to the manufacturer of the lock. Valli&Valli covers the main configurations of these manufacturers: Weathershield®, Sierra Pacific®, PGT®, Pella®, Paddock®, Milgard®, Marvin®, Loewen®, KFV®, Jeld-Wen®, Hoppe®, G-U®, Crestline®, BiltBest®, Atrium®, Ashland®

## 2. The distance between the lever and the cylinder (center to center)

Valli&Valli accomodates CTC distance of 92mm (3.5/8") standard only

## 3. The lever position on the plate if above or below the cylinder

This determines the different functions – see pages 153-154 for details

## 4. The cylinder used in the door: if American or Euro profile cylinder

The cylinder is always included in the configuration and pricing, unless differently specified.  
When all these 4 questions are answered, it is possible to proceed with the specification.

<b>1 LEVER MODEL</b>	Choose from all our collection of levers, ex. H383.
<b>2 TRIM OPTION</b>	Choose among the options at page 151, narrow long escutcheon plates or rosettes: Plates: NEP, NES, NER, NERS
<b>3 DOOR CONFIGURATION</b>	Please specify one of the 5 configurations from page 152.
<b>4 FUNCTION</b>	See pages 153-154 to determine.
<b>5 HANDING</b>	Follow the diagram at page 14 to determine RH, LH, RHR or LHR.
<b>6 FINISH</b>	NEP Available standard in 26 and 26D NER Available standard in 26 and 26D RSM Available standard in 26 and 26D NES, NERS and RSSM Available standard in 32D Different finishes available upon request. Choose from pages 20-21, pricing at page 15.
<b>7 DOOR THICKNESS</b>	1.3/4" is considered standard. Accomodates up to 2.1/4" thick door. Upcharges apply. See page 15.
<b>8 MISCELLANEOUS</b>	Note any special keying information, or special instruction.

<b>Examples:</b>	<b>1</b>	<b>2</b>	<b>3</b>	<b>4</b>	<b>5</b>	<b>6</b>	<b>7</b>	<b>8</b>
	H383	NEP	#1	EE	RH	56	1.3/4"	Off-set 55x47

# Trim options

Multi-Point trim

NES (K 5701)

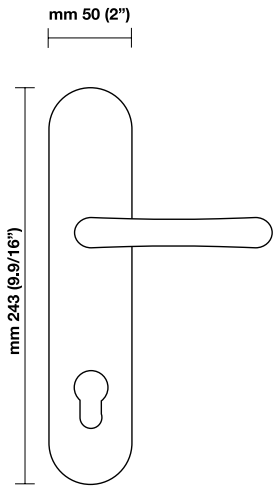

EE Exterior Plate  
Stainless steel

NES (K 5701)

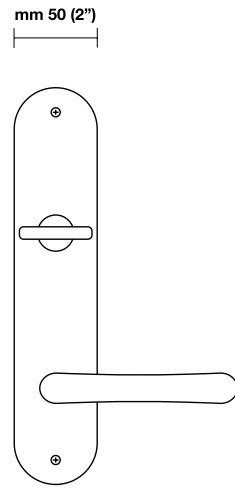

PAA Interior Plate  
Stainless steel

NEP (K 1789)

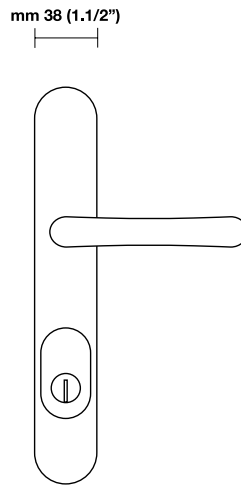

EAB Exterior Plate  
Solid brass

NEP (K 1789)

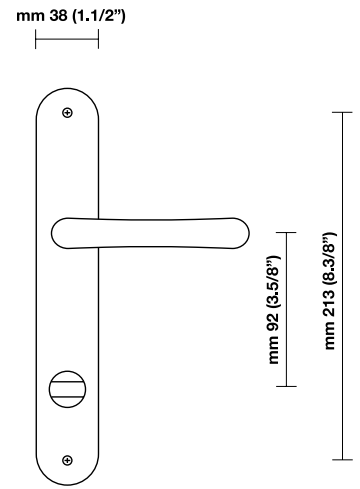

EAB Interior Plate  
Solid brass

NERS (K 5713)

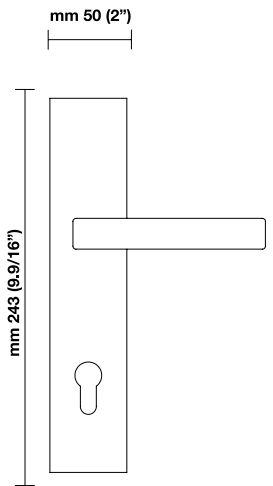

EE Exterior Plate  
Stainless steel

NERS (K 5713)

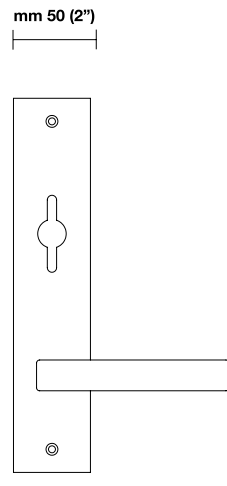

PAA Interior Plate  
Stainless steel

NER (K 1805)

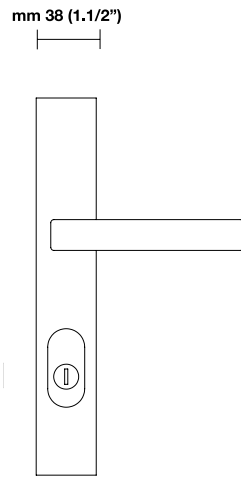

EAB Exterior Plate  
Solid brass

NER (K 1805)

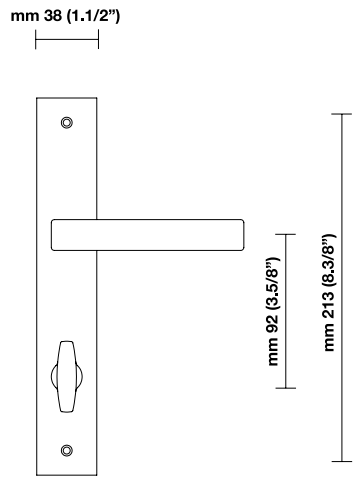

EAB Interior Plate  
Solid brass

RSSM

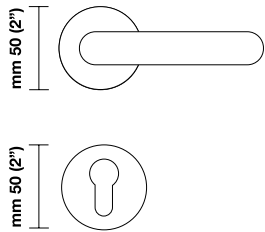

EE - PE  
Stainless steel

RSM

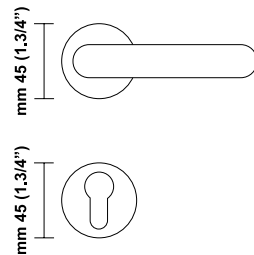

EE - PE  
Stainless steel

# Door configuration

Multi-Point trim



## Standard Valli configuration

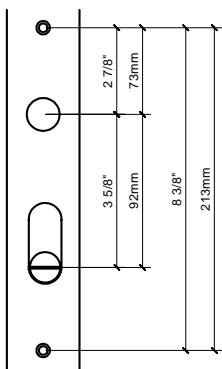

### Door configuration #1

American Cylinder Below Handle  
3.5/8" (92mm) Center to Center

Accommodates: Pella®, Milgard®

## Additional configuration

All the configurations below can also be accommodated for non-pre-drilled doors.  
The doors must be drilled as per the dimensions in our standard configuration.

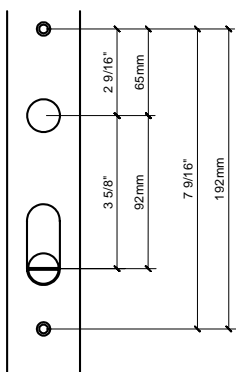

### Door configuration #2

American Cylinder Below Handle  
3.5/8" (92mm) CTC

Accommodates: Superior®, Paddock®,  
G-U®, Atrium®, Andersen®

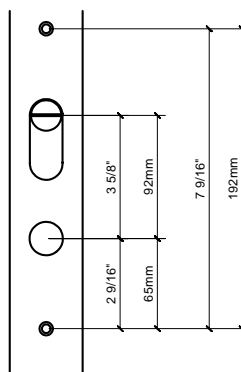

### Door configuration #3

American Cylinder Above Handle  
3.5/8" (92mm) CTC

Accommodates: Hurd®, G-U®,  
BiltBest®, Marvin®

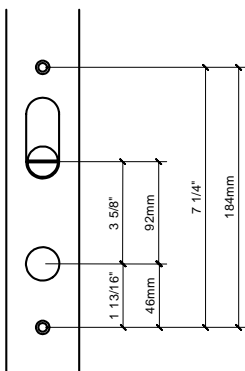

### Door configuration #4

American Cylinder Above Handle  
3.5/8" (92mm) CTC

Accommodates: Weathershield®,  
PGT®, Marvin®, JELD-WEN®,  
G-U®, Caradco®, Ashland®

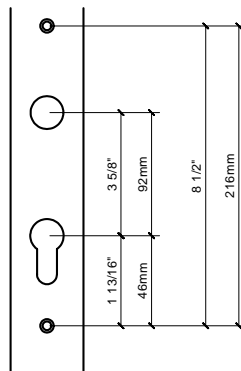

### Door configuration #5

European Profile Cylinder  
3.5/8" (92mm) CTC

Accommodates: Windsor®, Willmar®,  
Weathershield®, Vetter®,  
Therma-Tru®, Simpson®,  
Signature®, Sierra Pacific®,  
Semco®, Peachtree®, Paddock®,  
Loewen®, Lincoln®, Kolbe&Kolbe®,  
KFV®, Hurd®, Hoppe®, Crestline®

# Functions

Multi-Point trim

Available functions:

- EAA** – Entry set key above
- PAA** – Patio set no key, thumb turn above
- EE** – Entry set with Euro profile cylinder
- PE** – Patio set with Half Euro profile cylinder

- EAB** – Entry set key below
- PAB** – Patio set no key, thumb turn below
- DA** – Active dummy pair
- DS** – Single dummy piece



Rounded trim

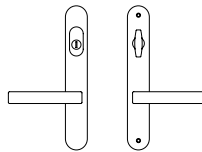

**EAA**

Rectangular trim

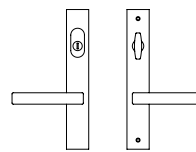

**EAA**

### **EAA Entry Set - Key above**

Entry function with American Cylinder above the lever, 3.5/8" (92mm) center to center.



Rounded trim

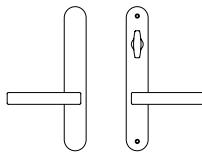

**PAA**

Rectangular trim

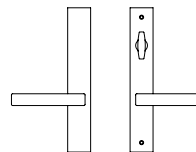

**PAA**

### **PAA Patio Set - No keyway**

Patio function with the interior thumbturn above the lever, no keyway on the exterior plate.



Rounded trim

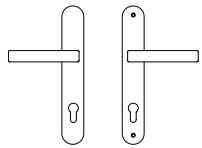

**EE**

Rectangular trim

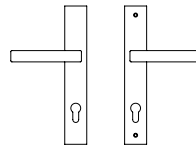

**EE**

### **EE Entry Set - With profile cylinder**

Entry function with European profile Cylinder. 3.5/8" (92mm) center to center.



Available RSM/RSSM

# Functions

Multi-Point trim



Rounded trim

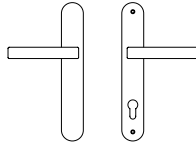

PE

Rectangular trim

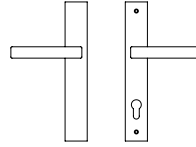

PE



Available RSM/RSSM

## PE Patio Set - Profile cylinder no key

Patio function with European Half profile Cylinder and thumbturn, no keyway on the exterior plate.



Rounded trim

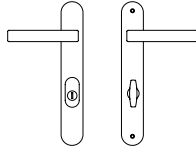

EAB

Rectangular trim

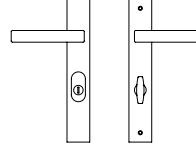

EAB

## EAB Entry Set - Key below

Entry function with American Cylinder below the lever, 3.5/8" (92mm) center to center.



Rounded trim

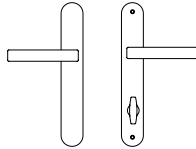

PAB

Rectangular trim

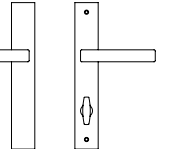

PAB

## PAB Patio Set - No keyway

Patio function with the interior thumbturn below the lever, no keyway on the exterior plate.

# Fusital Multi-Point

Material: Solid brass



## GROUP I

H315, H317, H326, H327, H330, H334, H338, H348, H361, H364, H367, H368, H370, H372, H381, H382, H383

	Retail Price		
	NEP 26 - 26D	NER 26 - 26D	RSM 26 - 26D
	<b>(K 1789)</b>	<b>(K 1805)</b>	
EAB Entry Set - key below	\$ 691.00	\$ 808.00	-
PAB Patio Set - no keyway	\$ 586.00	\$ 702.00	-
EAA Entry Set - key above	\$ 691.00	\$ 808.00	-
PAA Patio Set - no keyway	\$ 586.00	\$ 702.00	-
EE Entry Set - with profile cyl.	\$ 983.00	\$ 1,088.00	\$ 960.00
PE Patio Set - profile cyl. no key	\$ 656.00	\$ 762.00	\$ 562.00
DA Active Dummy	\$ 305.00	\$ 656.00	\$ 398.00

## GROUP II

H311, H329, H335, H343, H359, H369, H376, H378, H384

	Retail Price		
	NEP 26 - 26D	NER 26 - 26D	RSM 26 - 26D
	<b>(K 1789)</b>	<b>(K 1805)</b>	
EAB Entry Set - key below	\$ 819.00	\$ 935.00	-
PAB Patio Set - no keyway	\$ 702.00	\$ 832.00	-
EAA Entry Set - key above	\$ 819.00	\$ 935.00	-
PAA Patio Set - no keyway	\$ 702.00	\$ 832.00	-
EE Entry Set - with profile cyl.	\$ 1,111.00	\$ 1,216.00	\$ 1,088.00
PE Patio Set - profile cyl. no key	\$ 785.00	\$ 889.00	\$ 679.00
DA Active Dummy	\$ 434.00	\$ 772.00	\$ 527.00

**NEP:** Narrow long oval plate  
**NER:** Narrow long rectangular plate  
**RSM:** Small 45mm (1.3/4") rosette

The finishes above are considered standard.  
 Different finishes are available on special request.  
 See pages 20-21 for more options on finishes and page 15 for pricing.

The cylinders are included in the prices of all the corresponding configurations.

# Fusital Multi-Point

Material: Solid brass



## GROUP III

H350, H377

	Retail Price		
	NEP 26 - 26D (K 1789)	NER 26 - 26D (K 1805)	RSM 26 - 26D
EAB Entry Set - key below	\$ 1,170.00	\$ 1,286.00	-
PAB Patio Set - no keyway	\$ 1,065.00	\$ 1,182.00	-
EAA Entry Set - key above	\$ 1,170.00	\$ 1,286.00	-
PAA Patio Set - no keyway	\$ 1,065.00	\$ 1,182.00	-
EE Entry Set - with profile cyl.	\$ 1,462.00	\$ 1,579.00	\$ 1,439.00
PE Patio Set - profile cyl. no key	\$ 1,135.00	\$ 1,240.00	\$ 1,041.00
DA Active Dummy	\$ 785.00	\$ 1,135.00	\$ 878.00

## GROUP IV

H354, H356, H379, H380

	Retail Price		
	NEP 26 - 26D (K 1789)	NER 26 - 26D (K 1805)	RSM 26 - 26D
EAB Entry Set - key below	\$ 1,229.00	\$ 1,346.00	-
PAB Patio Set - no keyway	\$ 1,123.00	\$ 1,240.00	-
EAA Entry Set - key above	\$ 1,229.00	\$ 1,346.00	-
PAA Patio Set - no keyway	\$ 1,123.00	\$ 1,240.00	\$ 1,497.00
EE Entry Set - with profile cyl.	\$ 1,521.00	\$ 1,625.00	\$ 1,088.00
PE Patio Set - profile cyl. no key	\$ 1,193.00	\$ 1,310.00	\$ 935.00
DA Active Dummy	\$ 842.00	\$ 1,193.00	-

**NEP:** Narrow long oval plate  
**NER:** Narrow long rectangular plate  
**RSM:** Small 45mm (1.3/4") rosette

The finishes above are considered standard.  
 Different finishes are available on special request.  
 See pages 20-21 for more options on finishes and page 15 for pricing.

The cylinders are included in the prices of all the corresponding configurations.



# Fusital Inox Multi-Point

Material: Stainless steel AISI 316 L



## GROUP I H5008

	Retail Price		
	NES - 32D (K 1789)	NERS - 32D (K 1805)	RSSM - 32D
EAB Entry Set - key below	\$ 995.00	\$ 1,076.00	-
PAB Patio Set - no keyway	\$ 855.00	\$ 912.00	-
EAA Entry Set - key above	\$ 995.00	\$ 1,065.00	-
PAA Patio Set - no keyway	\$ 855.00	\$ 912.00	-
EE Entry Set - with profile cyl.	\$ 1,229.00	\$ 1,286.00	\$ 1,018.00
PE Patio Set - profile cyl. no key	\$ 889.00	\$ 912.00	\$ 656.00
DA Active Dummy	\$ 762.00	\$ 819.00	\$ 504.00

## GROUP II H5015/32D, H5017

	Retail Price		
	NES - 32D (K 1789)	NERS - 32D (K 1805)	RSSM - 32D
EAB Entry Set - key below	\$ 1,286.00	\$ 1,380.00	-
PAB Patio Set - no keyway	\$ 1,146.00	\$ 1,216.00	-
EAA Entry Set - key above	\$ 1,286.00	\$ 1,369.00	-
PAA Patio Set - no keyway	\$ 1,146.00	\$ 1,216.00	-
EE Entry Set - with profile cyl.	\$ 1,521.00	\$ 1,579.00	\$ 1,310.00
PE Patio Set - profile cyl. no key	\$ 1,193.00	\$ 1,206.00	\$ 960.00
DA Active Dummy	\$ 1,053.00	\$ 1,135.00	\$ 795.00

NEP: Narrow long oval plate  
 NER: Narrow long rectangular plate  
 RSM: Small 45mm (1.3/4") rosette

The finishes above are considered standard.  
 Different finishes are available on special request.  
 See pages 20-21 for more options on finishes and page 15 for pricing.

The cylinders are included in the prices of all the corresponding configurations.

# Fusital Inox Multi-Point

Material: Stainless steel AISI 316 L



## GROUP III

H5015 black leather, H5015 orange leather

	Retail Price		
	NES - 32D (K 1789)	NERS - 32D (K 1805)	RSSM - 32D
EAB Entry Set - key below	\$ 1,684.00	\$ 1,777.00	-
PAB Patio Set - no keyway	\$ 1,556.00	\$ 1,614.00	-
EAA Entry Set - key above	\$ 1,684.00	\$ 1,790.00	-
PAA Patio Set - no keyway	\$ 1,544.00	\$ 1,614.00	-
EE Entry Set - with profile cyl.	\$ 1,930.00	\$ 1,976.00	\$ 1,707.00
PE Patio Set - profile cyl. no key	\$ 1,602.00	\$ 1,614.00	\$ 1,346.00
DA Active Dummy	\$ 1,462.00	\$ 1,521.00	\$ 1,193.00

## GROUP IV

H5014

	Retail Price		
	NES - 32D (K 1789)	NERS - 32D (K 1805)	RSSM - 32D
EAB Entry Set - key below	\$ 795.00	\$ 878.00	-
PAB Patio Set - no keyway	\$ 656.00	\$ 715.00	-
EAA Entry Set - key above	\$ 795.00	\$ 865.00	-
PAA Patio Set - no keyway	\$ 656.00	\$ 715.00	-
EE Entry Set - with profile cyl.	\$ 1,030.00	\$ 1,088.00	\$ 819.00
PE Patio Set - profile cyl. no key	\$ 691.00	\$ 702.00	\$ 457.00
DA Active Dummy	\$ 562.00	\$ 609.00	\$ 305.00

NEP: Narrow long oval plate  
 NER: Narrow long rectangular plate  
 RSM: Small 45mm (1.3/4") rosette

The finishes above are considered standard.  
 Different finishes are available on special request.  
 See pages 20-21 for more options on finishes and page 15 for pricing.

The cylinders are included in the prices of all the corresponding configurations.





## Miscellaneous Parts

---

# Miscellaneous Parts

## MAGNETIC TUBULAR LATCH

Every lever and knob in our range can be matched to a magnetic tubular latch.

The latch is only available in 3 finishes: 26/Polished Chrome, 26D/Satin Chrome, 16/Dull Black.

The upcharge is **\$30.00 LIST** from the price of a standard tubular set. The price of the spare latches are listed below.

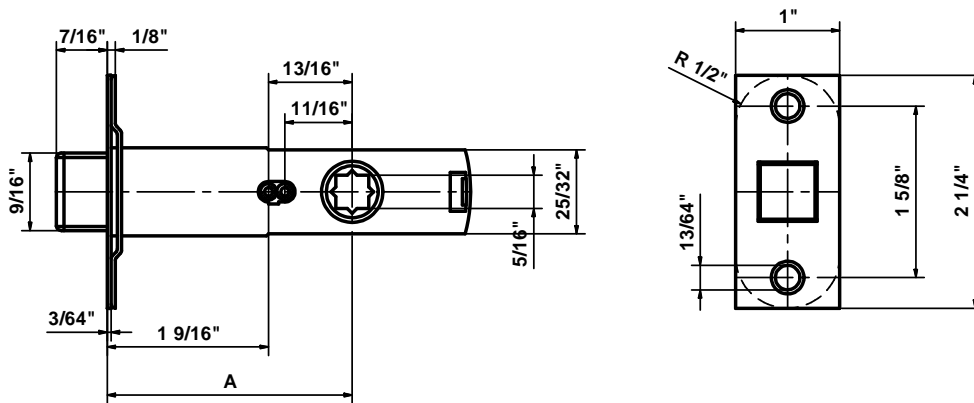

**A = 2.3/8" or 2.3/4"**

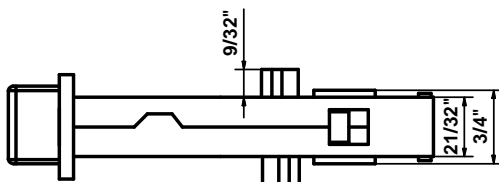

### Retail Price

Part No.	Backset	Functions	Overall latch size	26	26D	16
01M	2.3/8"	Passage	3.1/2"	\$ 60.00	\$ 60.00	\$ 60.00
02M	2.3/4"	Passage	3.7/8"	\$ 60.00	\$ 60.00	\$ 60.00
03M	2.3/8"	Privacy	3.1/2"	\$ 70.00	\$ 70.00	\$ 70.00
04M	2.3/4"	Privacy	3.7/8"	\$ 70.00	\$ 70.00	\$ 70.00

# Miscellaneous Parts

## TUBULAR LATCH BOLTS 28 DEGREES

### Retail Price

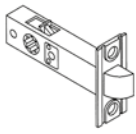

Part No.	Backset	Functions	Overall latch size	03	06	26/14	26D/15	OTHER
01L	2.3/8"	Passage	3.1/4"	\$ 40.00	\$ 40.00	\$ 40.00	\$ 40.00	\$ 60.00
02L	2.3/4"	Passage	3.5/8"	\$ 40.00	\$ 40.00	\$ 40.00	\$ 40.00	\$ 60.00
03L	2.3/8"	Privacy	3.1/4"	\$ 50.00	\$ 50.00	\$ 50.00	\$ 50.00	\$ 70.00
04L	2.3/4"	Privacy	3.5/8"	\$ 50.00	\$ 50.00	\$ 50.00	\$ 50.00	\$ 70.00

Includes: face plate, strike plate and screws. Retracts 28°. Magnetic latches available in finishes 26, 26D, 16. Check page 162 for pricing.

## DEADBOLT LATCH & PRIVACY BOLTS

### Retail Price

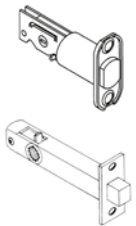

Part No.	Backset	Functions	Overall latch size	03	06	26/14	26D/15	OTHER
09	2.3/8"	Dead bolt	3.1/4"	\$ 84.00	\$ 84.00	\$ 84.00	\$ 84.00	\$ 95.00
10	2.3/4"	Dead bolt	3.5/8"	\$ 84.00	\$ 84.00	\$ 84.00	\$ 84.00	\$ 95.00
X 30	2.3/8"	Privacy bolt	3.5/16"	\$ 48.00	\$ 48.00	\$ 48.00	\$ 48.00	\$ 55.00
X 31	2.3/4"	Privacy bolt	3.3/4"	\$ 48.00	\$ 48.00	\$ 48.00	\$ 48.00	\$ 55.00

Above includes: deadbolt latch, mortise cylinder housing, strike plate for both metal and wood jambs, face plate and screws (no cylinder).

## HOUSINGS

### Retail Price

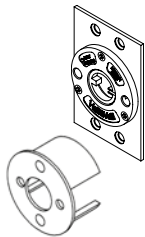

X 2122 / X 0436	Housing for rosettes	\$ 25.00 each
X 0403	Interior underosette to mount interior deadbolt trim	\$ 51.00 each
X 1116 / X 0545	Underrosettes for RP/Round Deadbolt	\$ 91.00 pair
X 0550	Underrosettes for RQ/Square Deadbolt	\$ 16.00 side
X 0547	Underrosettes for RQ Mortise lock	\$ 48.00 pair
X 2124M / X 0428	Housing, spring loaded for long escutcheon plates	\$ 20.00 each

## STRIKE PLATES

### Retail Price

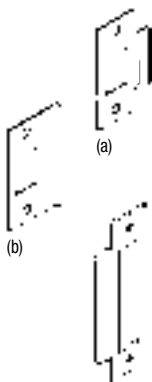

Part No.		03	06	15	26	26D	14
TS 01	T-strikes (tubular latch)	\$ 9.00	-	\$ 9.00	\$ 9.00	\$ 9.00	\$ 9.00
ETS-115	Extended for doors 2.1/4" thick	\$ 45.00	\$ 45.00	\$ 45.00	\$ 45.00	\$ 45.00	-
ETS-175	Extended for doors 2.1/2" & up	\$ 45.00	\$ 45.00	\$ 45.00	\$ 45.00	\$ 45.00	-
FL 01	Full lip (tubular latch)	\$ 8.00	\$ 8.00	\$ 8.00	\$ 8.00	\$ 8.00	\$ 8.00
EL-115	Extended for doors 2.1/4" thick	\$ 45.00	\$ 45.00	\$ 45.00	\$ 45.00	\$ 45.00	-
EL-175	Extended for doors 2.1/2" & up	\$ 45.00	\$ 45.00	\$ 45.00	\$ 45.00	\$ 45.00	-
ML 01	Mortise lock strikes	\$ 55.00	\$ 55.00	\$ 55.00	\$ 55.00	\$ 55.00	-
ML 02	Extended for 2.1/4" thick	\$ 55.00	\$ 55.00	\$ 55.00	\$ 55.00	\$ 55.00	-
ML 03	Extended for 2.3/8" & up	\$ 55.00	\$ 55.00	\$ 55.00	\$ 55.00	\$ 55.00	-

(a) T-strike (b) Full lip (c) Mortise

# Miscellaneous Parts

## ROSETTES

### Retail Price

RT Traditional 2.9/16" (65mm)	03/03D	14	15	26/26D	OTHER
K 1749 RS (ML) threaded each	\$ 40.00	\$ 49.00	\$ 42.00	\$ 41.00	\$ 49.00
K 1741 RRS PGE CP	\$ 35.00	\$ 54.00	\$ 45.00	\$ 36.00	\$ 55.00
K 1741 RRS PCY CPK	\$ 50.00	\$ 75.00	\$ 59.00	\$ 50.00	\$ 75.00
K 1741 RRS SF (DMY) each	\$ 18.00	\$ 28.00	\$ 23.00	\$ 18.00	\$ 27.00



RP Round 2.9/16" (65mm)	03/03D	14	15	26	26D	OTHER
K 1748 RS (ML) threaded each	\$ 38.00	\$ 50.00	\$ 46.00	\$ 38.00	\$ 46.00	\$ 50.00
K 1742 RRS PGE CP	\$ 41.00	\$ 42.00	\$ 49.00	\$ 39.00	\$ 42.00	\$ 66.00
K 1742 RRS PCY CPK	\$ 50.00	\$ 52.00	\$ 59.00	\$ 45.00	\$ 52.00	\$ 82.00
K 1742 RRS SF (DMY) each	\$ 19.00	\$ 21.00	\$ 25.00	\$ 18.00	\$ 21.00	\$ 34.00



RS Round	03/03D	14	15	26	26D	OTHER
K 1112 RS 1.3/4" (45 mm) each	\$ 30.00	\$ 32.00	\$ 32.00	\$ 30.00	\$ 32.00	\$ 34.00
K 1121 RS 2" (50 mm) each	\$ 30.00	\$ 32.00	\$ 32.00	\$ 30.00	\$ 32.00	\$ 34.00



RPS Stainless steel Round 2.9/16" (65mm)	32	32D
R 5701 (ML) threaded each	\$ 135.00	\$ 103.00
R 5703 RRS PGE	\$ 108.00	\$ 113.00
R 5703 RRS PCY CPK	\$ 126.00	\$ 113.00
R 5703 RRS SF (DMY) each	\$ 55.00	\$ 57.00



RSS Stainless steel Round 2" (50mm)	32	32D
R 5704 RRS PGE	\$ 75.00	\$ 54.00
R 5702 RS (DMY) each	\$ 25.00	\$ 19.00



RQ Square 2.9/16" (65mm)	14	15	26	26D	OTHER
K 1780 RS I (inside) ML each	\$ 95.00	\$ 95.00	\$ 79.00	\$ 95.00	\$ 95.00
K 1780 RS E (outside) ML each	\$ 95.00	\$ 95.00	\$ 79.00	\$ 95.00	\$ 95.00
K 1798 RRS PGE	\$ 178.00	\$ 163.00	\$ 149.00	\$ 163.00	\$ 178.00
K 1798 RRS PCY	\$ 188.00	\$ 173.00	\$ 173.00	\$ 188.00	\$ 188.00
K 1798 RRS (DMY) each	\$ 95.00	\$ 95.00	\$ 79.00	\$ 94.00	\$ 95.00

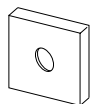

RSQ Square 2" (50mm)	26	26D	OTHER
K 1138 RS each	\$ 34.00	\$ 44.00	\$ 44.00





## ROSETTES

### Retail Price

RQS Stainless steel Square 2.9/16" (65mm)	32	32D
R 5709 RS I (inside) ML each	\$ 160.00	\$ 122.00
R 5709 RS E (outside) ML each	\$ 160.00	\$ 122.00
R 5707 RRS PGE	\$ 302.00	\$ 233.00
R 5707 RRS PCY	\$ 328.00	\$ 252.00
R 5707 RRS (DMY) each	\$ 160.00	\$ 122.00

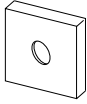

## MORTISE CYLINDERS - C Keyway

### Retail Price

Part No.	Door Thickness	03	06B	15	26	26D
C 01 15/16 cyl.	1.3/8" D	\$ 40.00	\$ 40.00	\$ 40.00	\$ 40.00	\$ 40.00
C 02 1.1/8 cyl.	1.3/4" D	\$ 40.00	\$ 40.00	\$ 40.00	\$ 40.00	\$ 40.00
C 03 1.1/4 cyl.	2" D - 1.3/4" M	\$ 40.00	\$ 40.00	\$ 40.00	\$ 40.00	\$ 40.00
C 04 1.3/8 cyl.	2.1/4" D - 2" M	\$ 40.00	\$ 40.00	\$ 40.00	\$ 40.00	\$ 40.00
C 05 1.1/2 cyl.	2.1/2" D - 2.1/4" M	\$ 40.00	\$ 40.00	\$ 40.00	\$ 40.00	\$ 40.00



Must specify Deadbolt (D) or Mortise Lock (M). Straight cam is used for mortise locks without thumbturns.

## PROFILE CYLINDERS - C Keyway

### Retail Price

Part No.	Description	Door Thickness	03	26	15-26D	32D
C 07 35 mm	Key by thumbturn		\$ 40.00	\$ 40.00	\$ 40.00	-
C 08 72 mm	Key by thumbturn profile cylinder	1.3/4"	\$ 400.00	\$ 400.00	\$ 400.00	-
C 09 81 mm	Key by thumbturn profile cylinder	2.1/4"	\$ 400.00	-	\$ 400.00	-
C 12 45 mm	Half profile profile cylinder with thumbturn		\$ 400.00	\$ 400.00	\$ 400.00	-
C 13 50 mm	Half profile profile cylinder with thumbturn		\$ 400.00	-	\$ 400.00	-
C 14 45 mm	Half profile profile cylinder with keyway		\$ 400.00	-	\$ 400.00	-
K 1799/6	Thumbturn for profile cylinder (brass)		\$ 40.00	\$ 40.00	\$ 40.00	-
S 5702 BZG MP	Thumbturn for profile cylinder (stainless steel)		-	-	-	\$ 79.00

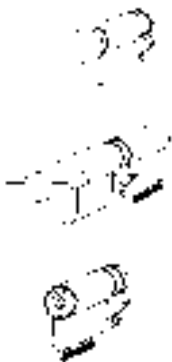

Must add price of thumbturn to profile cylinder.

## ALLEN WRENCHES & SET SCREW (metric)

### Retail Price

X 0286 Set screws with allen wrench for stainless steel levers and knobs	\$ 13.00
W 04 Allen wrench for deadbolt cylinder locking screw	\$ 3.00



Set screws with allen wrenches for brass levers and knobs: Set screws size  $\varnothing$ =mm 6 wide x 9 long

## DUST BOX

### Retail Price

Part No.	Description	03	26	15-26D	32D
DB-04	Dust Box T Strike	-	-	-	\$ 6.00
DB-03	Dust Box Full Lip Strike	-	-	-	\$ 6.00
DB-02	Dust Box Mortise Lock	\$ 6.00	\$ 6.00	\$ 11.00	-

## MORTISE LOCKS

Must specify 2.1/2" or 2.3/4" backset. Must specify for levers or knobs. Includes: mortise lock body, face plate, strike plate, screws and dust box (no cylinder). Custom mortise locks and other backsets available upon special request. UL listed 3 hours fire rating.

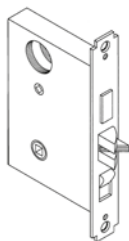

Part No.	Description	Retail Price
		2.1/2" - 2.3/4"
ML-F	Entrance (Lever Sets)	\$ 300.00
ML-FD	Entrance	\$ 400.00
ML-FW	Entrance	\$ 300.00
ML-J	Classroom	\$ 400.00
ML-AC	Entrance	\$ 300.00
ML-N	Passage	\$ 300.00
ML-B	Entrance	\$ 300.00
ML-NC	Communicating	\$ 400.00
ML-E	Office	\$ 400.00
ML-LF	Privacy	\$ 300.00
ML-ELEC	Electrified	\$ 2,000.00
ML-EW	Storeroom	\$ 300.00
ML-H	Hotel	\$ 300.00
ML-DEADLOCK	Mortise deadlock	\$ 150.00
ML-PL2000 PGE	Mortise lock for passage pocket door	\$ 350.00
ML-PL2002 PCY	Mortise lock for privacy pocket door	\$ 400.00

See page 117 for details on functions.

## SPINDLES

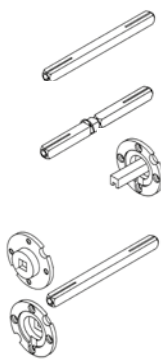

Part No.	Description	Overall length	Retail Price
X 016	8mm, solid spindle for doors 1.3/8" to 2.1/4"	4.1/2"	\$ 10.00
X 0100/8 -145	8mm, solid spindle for doors 2.3/8" to 3"	5.5/8"	\$ 20.00
X 0163 / X 1119-114	8mm, split spindle for doors 1.3/8" to 2.1/4"	4.1/2"	\$ 15.00
X 0163 / X 1119-145	8mm, split spindle for doors 2.3/8" to 3"	5.3/4"	\$ 15.00
X 0571	8mm, surface mounted dummy (for round rosette)		\$ 25.00
X 0571 OT SQ	8mm, surface mounted dummy (for square rosette)		\$ 28.00
X 0572	8mm, opposing mounted dummy plates		\$ 27.00
X 1118	5mm/tailpiece, for deadbolts with doors 1.3/8" to 1.3/4"		\$ 7.00
X 117/5-60	5mm x 60mm, for mortise lock functions with doors 1.3/4"		\$ 4.00
X 117/5-85	5mm x 85mm, for 105 privacy bolts with doors up to 1.3/4"		\$ 4.00

## DEADBOLT, PRIVACY BOLT, MORTISE TRIM ONLY

Part No.	03/03D	14	15	26	26D	32	32D	26/26D	OTHER
K 1724 RS BZG Interior trim for 105 RST (traditional)	\$ 83.00	\$ 100.00	\$ 86.00	-	-	-	-	\$ 109.00	\$ 113.00
K 1724 RS VBZG Exterior trim for 105 RST (traditional) Emergency release	\$ 83.00	\$ 100.00	\$ 92.00	-	-	-	-	\$ 109.00	\$ 113.00
K 1725 RS BZG Interior trim for 105 RSP (round)	\$ 74.00	\$ 95.00	\$ 89.00	\$ 74.00	\$ 89.00	-	-	-	\$ 100.00
K 1725 RS VBZG Exterior trim for 105 RSP (round) Emergency release	\$ 74.00	\$ 95.00	\$ 89.00	\$ 74.00	\$ 89.00	-	-	-	\$ 74.00
S 5700 RS BZG Interior trim for 105 RSS (stainless steel)	-	-	-	-	-	\$ 192.00	\$ 166.00	-	-
S 5700 RS VBZG Exterior trim for 105 RSS (stainless steel) Emergency release	-	-	-	-	-	\$ 149.00	\$ 114.00	-	-

K 1725



S 5700



## DEADBOLT, PRIVACY BOLT, MORTISE TRIM ONLY

Part No.	03/03D	14	15	26	26D	32	32D	26/26D	OTHER
K 1781 K 1781 RS BZG Interior trim for 105 RSQ (square)	-	\$ 176.00	\$ 161.00	\$ 146.00	\$ 161.00	-	-	-	\$ 161.00
K 1781 RS VBZG Exterior trim for 105 RSQ (square) Emergency release	-	\$ 176.00	\$ 161.00	\$ 146.00	\$ 161.00	-	-	-	\$ 161.00
S 5703 RS BZG Interior trim for 105 RSQS (square) stainless steel	-	-	-	-	-	\$ 259.00	\$ 199.00	-	-
S 5703 RS VBZG Exterior trim for 105 RSQS (square) stainless steel Emergency release	-	-	-	-	-	\$ 185.00	\$ 142.00	-	-
K 1728 RS BZG Interior trim for traditional deadbolt (101 RT)	\$ 72.00	\$ 82.00	\$ 79.00	-	\$ 82.00	-	-	-	\$ 94.00
K 1749 RSC Exterior trim for traditional deadbolt (101 RT)	\$ 40.00	\$ 49.00	\$ 42.00	-	-	-	-	\$ 41.00	\$ 49.00
K 1729 RS BZG Interior trim for traditional deadbolt (101 RT)	\$ 98.00	\$ 79.00	\$ 79.00	\$ 72.00	\$ 79.00	-	-	-	\$ 98.00
K 1748 RSC Exterior rosette for round deadbolt (101 RP)	\$ 44.00	\$ 48.00	\$ 48.00	\$ 44.00	\$ 48.00	-	-	-	\$ 50.00
R 5701 RS BZG Interior trim for round stainless deadbolt (101 RPS)	-	-	-	-	-	\$ 234.00	\$ 179.00	-	-
R 5705 RS Exterior trim for round stainless deadbolt (101 RPS)	-	-	-	-	-	\$ 134.00	\$ 103.00	-	-
R 5708 RS BZG Interior trim for square stainless deadbolt (101 RQS)	-	-	-	-	-	\$ 262.00	\$ 202.00	-	-
R 5709 RS Exterior trim for square stainless deadbolt (101 RQS)	-	-	-	-	-	\$ 164.00	\$ 126.00	-	-
K 1778 RS BZG Interior trim for square brass deadbolt (101 RQ)	-	\$ 193.00	\$ 161.00	\$ 146.00	\$ 161.00	-	-	-	\$ 161.00
K 1780 RSC Exterior trim for square brass deadbolt (101 RQ)	-	\$ 93.00	\$ 99.00	\$ 84.00	\$ 99.00	-	-	-	\$ 99.00
K 1726 Mortise lock cylinder collar (traditional)	\$ 45.00	\$ 45.00	\$ 45.00	\$ 37.00	\$ 42.00	-	-	-	\$ 51.00
S 1727 Mortise lock cylinder collar round (brass)	\$ 54.00	\$ 49.00	\$ 49.00	\$ 44.00	\$ 45.00	-	-	-	\$ 54.00
R 5700 Mortise lock cylinder collar round (stainless steel)	-	-	-	-	-	\$ 99.00	\$ 81.00	-	-
K 1767 Mortise lock cylinder collar square (brass)	-	\$ 111.00	\$ 101.00	\$ 92.00	\$ 92.00	-	-	-	\$ 101.00
R 5710 Mortise lock cylinder collar square (stainless steel)	-	-	-	-	-	\$ 136.00	\$ 104.00	-	-
X 1121 K / X 0228 Cylinder collar for exterior rosette for deadbolt (brass)	\$ 20.00	\$ 20.00	\$ 20.00	\$ 20.00	\$ 20.00	-	-	-	\$ 20.00
X 1121 K / X 0237 Cylinder collar for exterior rosette for deadbolt (stainless)	-	-	-	-	-	\$ 40.00	\$ 40.00	-	-
K 1806/1225 RS BZG Interior trim for K 1225 RSQ (square)	-	\$ 183.00	\$ 161.00	\$ 146.00	\$ 161.00	-	-	-	\$ 161.00
K 1806 RS VBZG Exterior trim K 1225 RSQ (square) Emergency release	-	\$ 183.00	\$ 161.00	\$ 146.00	\$ 161.00	-	-	-	\$ 161.00

K 1781

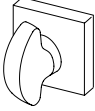

S 5703

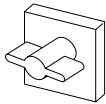

K 1729



## PRIVACY PINS

Part No.	Description	Finish options	Retail Price
X 0227	Pin for tubular latch (M3 thread)	03, 03D, 06A, 06B, 26, 26D, 16	\$ 12.00
X 0248	Pin for tubular latch stainless steel (M3 thread)	32, 32D	\$ 14.00

## FASTNERS

Part No.	Description	Retail Price
X 176	Retaining ring to attach levers to rosettes and long escutcheons. Specify RH - LH	\$ 4.00
X 187	Metal washer	\$ 3.00
X 184	Retaining clip to attach thumbturns to rosettes and long escutcheons	\$ 3.00
X 1161	Locking o-ring to attach levers to rosettes and long escutcheon plates	\$ 3.00
X 1162	Stainless steel washer	\$ 3.00
X 1167	Stainless steel washer	\$ 3.00
X 0326	Nylon bushing to convert 8mm to 5mm	\$ 3.00
X 0339	Nylon bushing to convert 8mm to a flat tailpiece	\$ 3.00
X 1100	Spring for lever and rosette assembly	\$ 2.00
X 1107	Small nylon washer	\$ 2.00
X 1105	Medium nylon washer	\$ 2.00
X 1106	Large nylon washer	\$ 2.00

## METRIC SCREWS FOR DOOR SETS

Part No.	Description	Retail Price
X 15	Standard pack for 1.3/8" or 1.3/4" doors (rosettes)	\$ 3.00
X 17	Standard pack for 1.3/8" or 1.3/4" doors (long escutcheons)	\$ 5.00
M4 x 30mm (1.1/4")		\$ 1.00
M4 x 40mm (1.1/2")		\$ 1.00
M4 x 50mm (2")		\$ 1.00
M4 x 90mm (3.1/2") non-cut & unfinished		\$ 1.00

## DOOR PULL MOUNTING KITS

### X 0508

For mounting a single pull handle on a wooden door thickness:

45-60 mm

60-75 mm

75-90 mm

On a glass door, thickness: 8-12 mm

For pulls:

**K 353 - P5405 25 - P5406 25 - P5408 25**

Recommended hole diameter:

wooden door:  $\varnothing$  9 mm

glass door:  $\varnothing$  11 mm

**Retail price \$ 84.00**

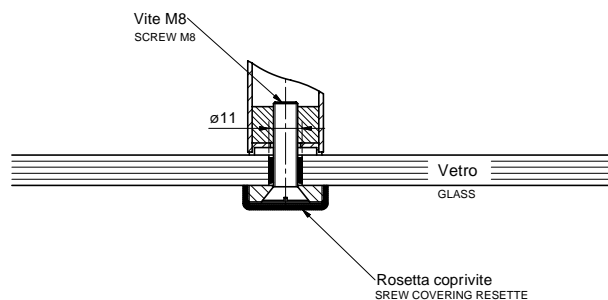
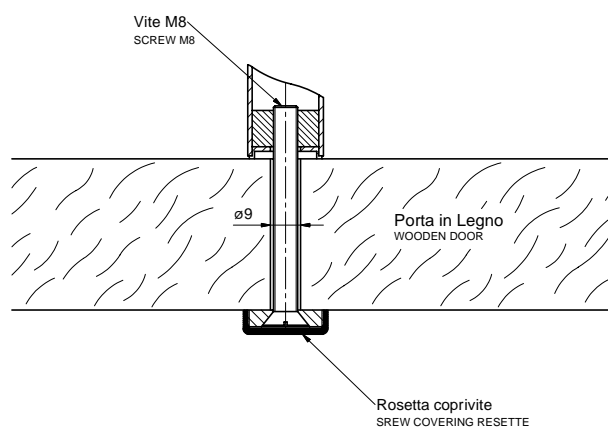

### X 0509

For mounting a pair of pull handles on a wooden door thickness:

45-60 mm

60-75 mm

75-90 mm

For pulls:

**K 353 - P5405 25 - P5406 25 - P5408 25**

Recommended hole diameter:

$\varnothing$  9 mm

**Retail price \$ 63.00**

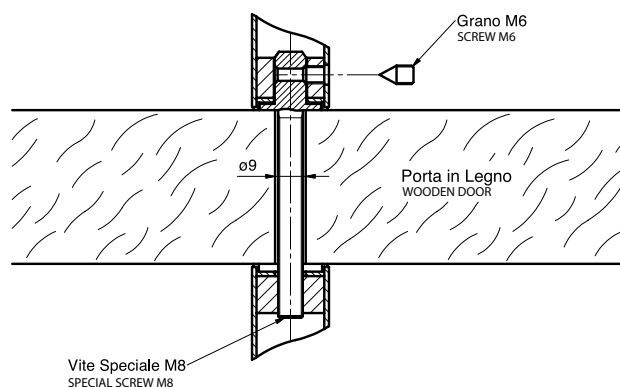

## DOOR PULL MOUNTING KITS

### X 0510

For mounting a single pull handle on a wooden door or on a masonry wall using a brass anchor screw.

For pulls:

**K 353 S - P5405 S 25 - P5406 S 25 - P5408 S 25**

For mounting a pair of pull handle

on a glass door, thickness: 8-12 mm

For pulls:

**K 353 - P5405 25 - P5406 25 - P5408 25**

Recommended hole diameter:

wooden door:  $\varnothing$  10.2 mm

glass door:  $\varnothing$  11 mm

**Retail price \$ 63.00**

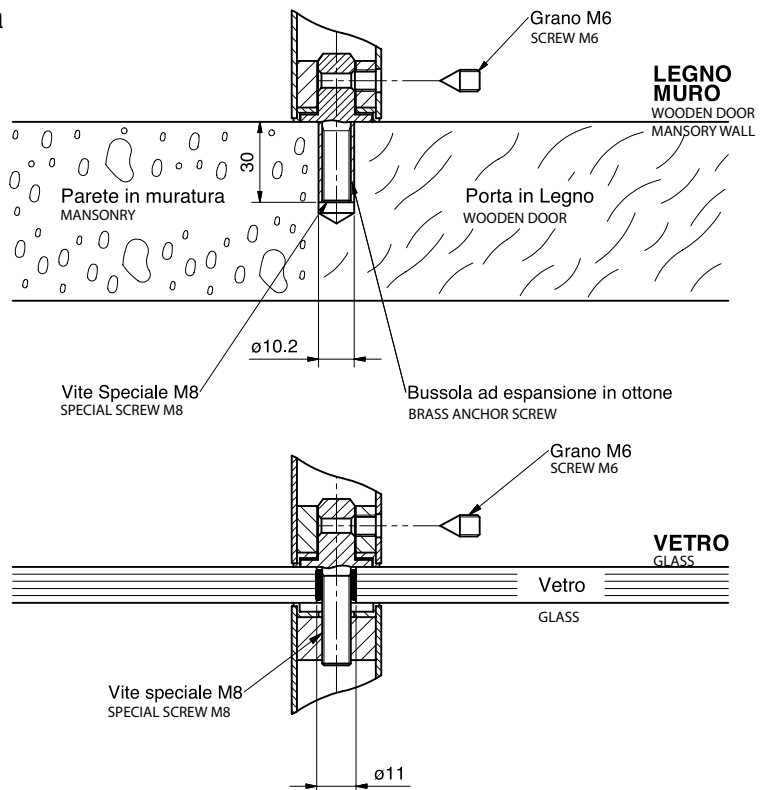

### X 0523

For mounting a pair of pull handles with screw-covering

rosettes on a wooden door, thickness:

45-55 mm

55-65 mm

On a glass door, thickness: 8-12 mm

For pulls:

**K 352 RH/LH - K 356 - K 368 - K 377 - K 378 - K 383**

Recommended hole diameter:

wooden door:  $\varnothing$  6.5 mm

glass door:  $\varnothing$  9 mm

**Retail price \$ 63.00**

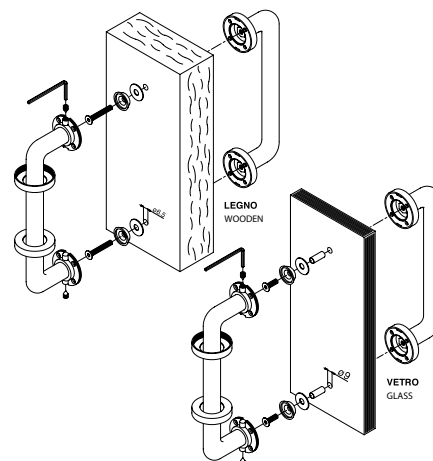

## DOOR PULL MOUNTING KITS

### X 0525

For mounting a single pull handle with rosettes on a wooden door, thickness:

45-55 mm

55-65 mm

On a glass door, thickness: 8-12 mm

For pulls:

**K 352 RH/LH - K 356 - K 368 - K 377 - K 378 - K 383**

Recommended hole diameter:

wooden door:  $\varnothing$  6.5 mm

glass door:  $\varnothing$  9 mm

**Retail price \$ 84.00**

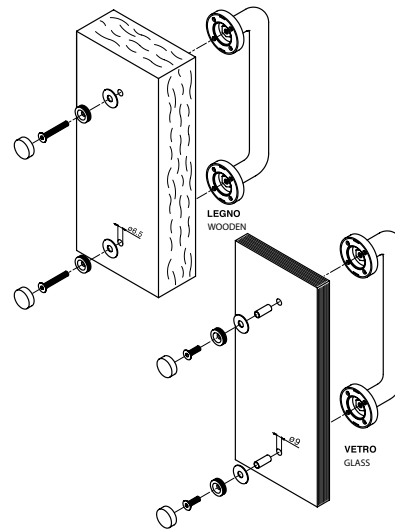

### X 0526

For mounting a single pull handle with screw-covering rosettes on wooden door or on a masonry wall using a brass anchor screw.

For pulls:

**K 352 RH/LH - K 356 - K 368 - K 377 - K 378 - K 383**

Recommended hole diameter:  $\varnothing$  8.2 mm

**Retail price \$ 53.00**

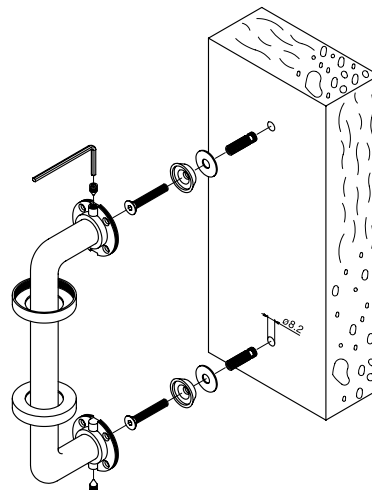

### X 0528

For mounting a pair of pull handles without screw-covering rosettes on a wooden door, thickness:

45-55 mm

55-65 mm

On a glass door, thickness: 8-12 mm

For pulls:

**K 358 - K 359 - K 378 - K 379 - K 380 - K 381 - K 383**

For pulls:

**K 356 - K 368 - K 377**

(Before installation roses may be removed)

Recommended hole diameter:

wooden door:  $\varnothing$  6.5 mm

glass door:  $\varnothing$  9 mm

**Retail price \$ 63.00**

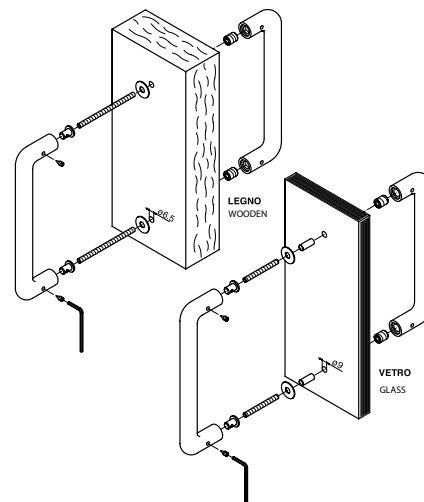

## DOOR PULL MOUNTING KITS

### X 0530

For mounting a single pull handle without rosettes on a wooden door, thickness:

45-55 mm

55-65 mm

On a glass door, thickness: 8-12 mm

For pulls:

**K 358 - K 359 - K 378 - K379 - K380 - K381 - K383**

For pulls:

**K 356 - K 368 - K 377**

(Before installation roses may be removed)

Recommended hole diameter:

wooden door: Ø 6.5 mm

glass door: Ø 9 mm

**Retail price \$ 84.00**

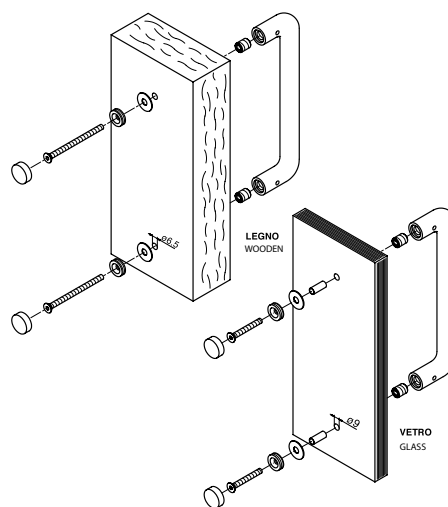

### X 0531

For mounting a single pull handle without rosettes on a wooden door or on a masonry wall using a brass anchor screw.

For pulls:

**K 358 - K 359 - K 378 - K379 - K380 - K381 - K383**

For pulls:

**K 356 - K 368 - K 377**

(Before installation roses may be removed)

Recommended hole diameter: Ø 8.2 mm

**Retail price \$ 53.00**

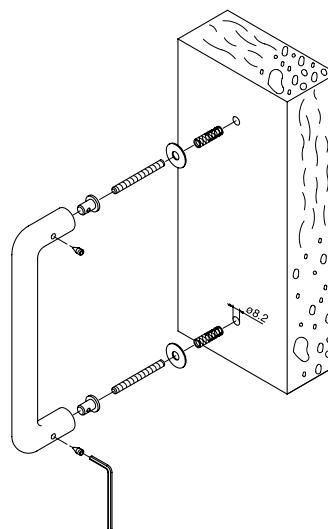

### X 0544

For mounting a single pull handle without rosettes on a burglary-proof steel-clad door.

For pulls:

**K 358 - K 359 - K 378 - K379 - K380 - K381 - K383**

For pulls:

**K 356 - K 368 - K 377**

(Before installation roses may be removed)

**Retail price \$ 84.00**

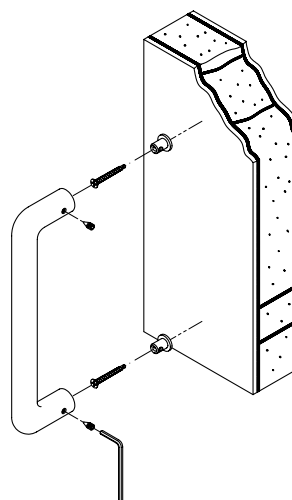



## DOOR PULL MOUNTING KITS

### X 0544/1

For mounting a single pull handle without rosettes on a burglary-proof steel-clad door.

For pulls:  
**K 353 S - P5405 S 25 - P5406 S 25 - P5408 S 25**

**Retail price \$ 53.00**

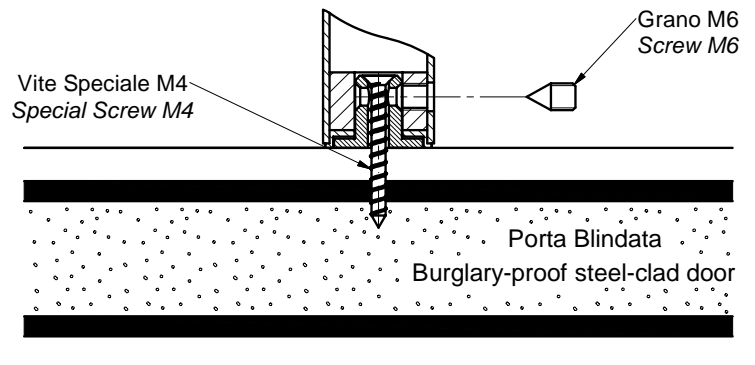

### X 0551

For mounting a single pull handle without screw-covering rosettes on an aluminum door.

For pulls:  
**K 358 - K 359 - K 378 - K379 - K380 - K381 - K383**

For pulls:  
**K 356 - K 368 - K 377**  
 (Before installation roses may be removed)

Recommended hole diameter:  $\varnothing$  13 mm

**Retail price \$ 84.00**

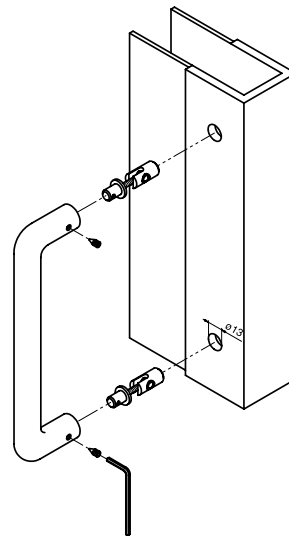

### X 0552

For fixing a single pull handle without screw-covering rosettes on an aluminum door.

For pulls:  
**K 353 S - P 5405 S 25 - P5406 S 25 - P5408 S 25**

Recommended hole diameter:  $\varnothing$  13 mm

**Retail price \$ 84.00**

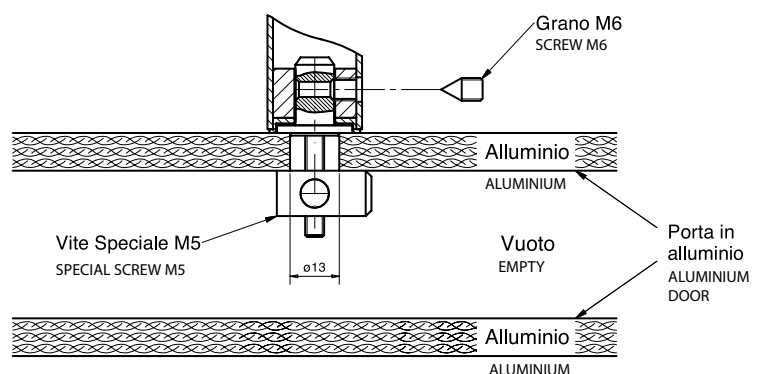

## DUMMY SET ADAPTORS Round rosettes - solid brass

### X 003/1 Double RP

Set includes: 2 underosettes, 1 latch bolt blank  
BACKSET 2.3/4" and 2.3/8"

**Retail price \$ 79.00**

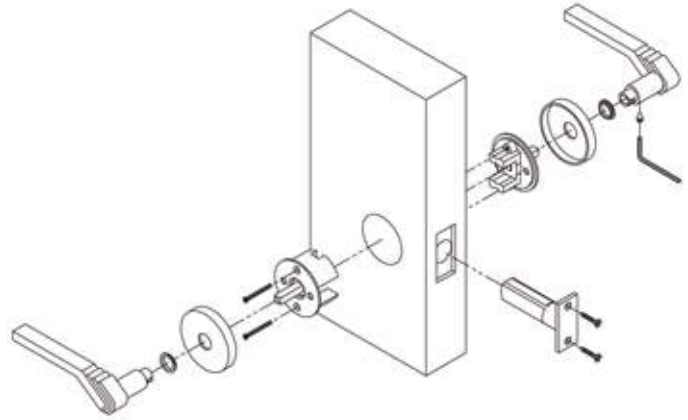

### X 003/2 Single RP

Set includes: 1 underosette, 1 latch bolt blank, 1 blind  
brass rosette for opposite side.  
BACKSET 2.3/4" and 2.3/8"

**Retail price \$ 95.00**

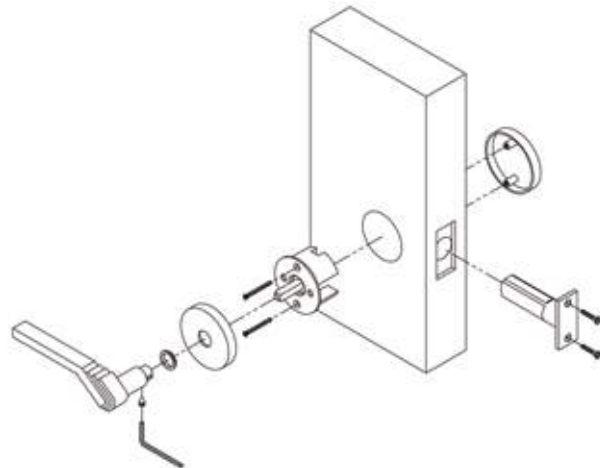

## DUMMY SET ADAPTORS Square rosette - Solid Brass

### X 003/1 Double RQ

Set includes: 2 underosettes, 1 latch bolt blank  
BACKSET 2.3/4" and 2.3/8"

**Retail price \$ 79.00**

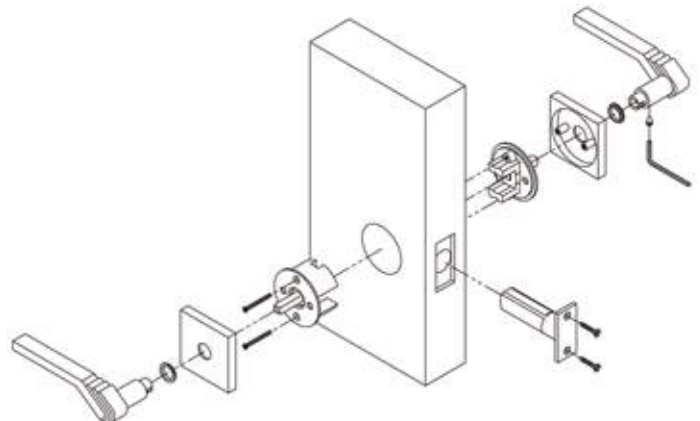

## DUMMY SET ADAPTORS Square rosette - Solid Brass

### X 003/2 Single RQ

Set includes: 1 underosette, 1 latch bolt blank, 1 blind brass rosette for opposite side.  
BACKSET 2.3/4" and 2.3/8"

**Retail price \$ 95.00**

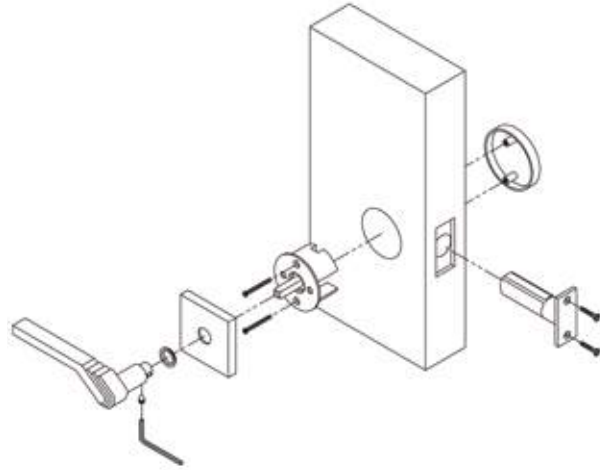

## DUMMY SET ADAPTORS Round rosette - Stainless Steel

### X 003/1 Double RPS

Set includes: 2 underosettes, 1 latch bolt blank  
BACKSET 2.3/4" and 2.3/8"

**Retail price \$ 79.00**

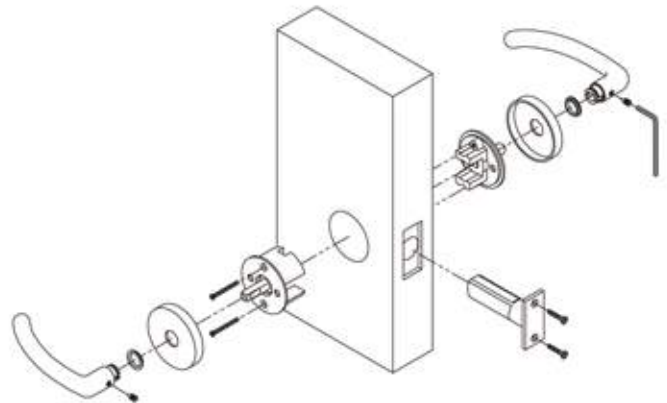

### X 003/2 Single RPS

Set includes: 1 underosette, 1 latch bolt blank, 1 blind brass rosette for opposite side.  
BACKSET 2.3/4" and 2.3/8"

**Retail price \$ 95.00**

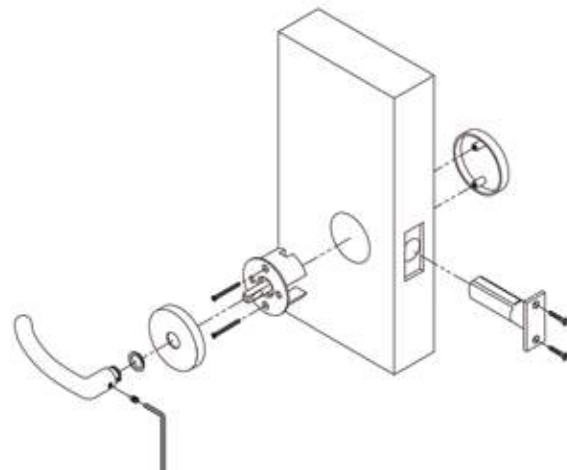

## DUMMY SET ADAPTORS Square rosette - Stainless Steel

### X 003/1 Double RQS

Set includes: 2 underosettes, 1 latch bolt blank  
BACKSET 2.3/4" and 2.3/8"

**Retail price \$ 79.00**

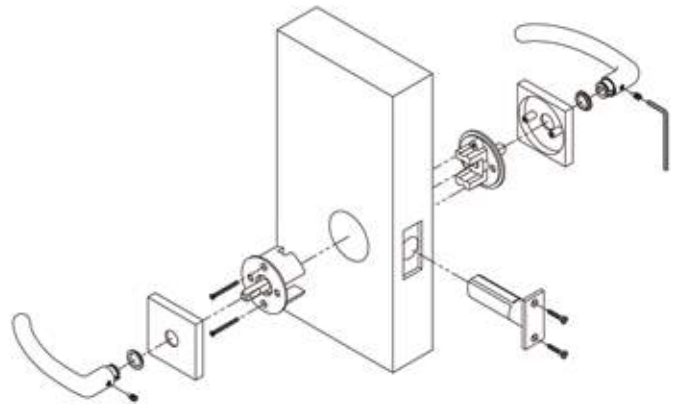

### X 003/2 Single RQS

Set includes: 1 underosette, 1 latch bolt blank, 1 blind  
brass rosette for opposite side.  
BACKSET 2.3/4" and 2.3/8"

**Retail price \$ 95.00**

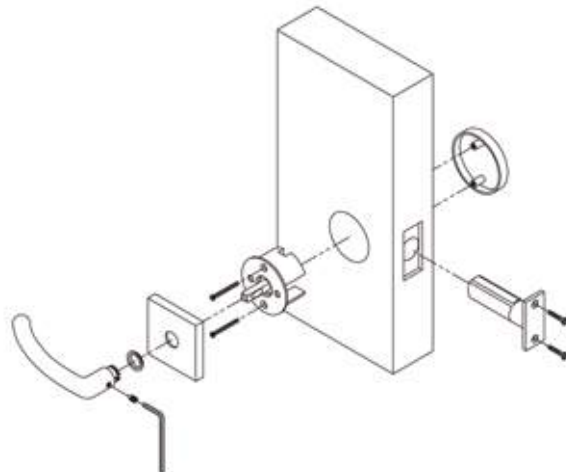





## List of door thicknesses

---

*Technical information  
can be viewed under  
"Technical Documents" at  
[www.vallivalli-us.com](http://www.vallivalli-us.com)*

# List of door thickness for each door lever

Each lever/knob design accommodates a different spindle length, based on the shape of the shank. See below the list of the standard spindle lengths for each model. Our set-up is for 1.3/4" thick door. Different door thicknesses must be specified at the time of the order. The below is for reference only.

## DOOR LEVERS

Article	Series	Thickness from	to	1.3/4" with spindle	1.3/8" with spindle
H 311	MB Sei	30 mm	60 mm	8 x 114 mm	
H 315	G Novanta	33 mm	55 mm	8 x 114 mm	
H 317	AC Novantuno	33 mm	55 mm	8 x 114 mm	
H 326	AC1 Novantacinque	33 mm	55 mm	8 x 114 mm	
H 327	AC2 Novantacinque	33 mm	55 mm	8 x 114 mm	
H 329	RB Novantacinque	33 mm	55 mm	8 x 114 mm	
H 330	T Novantasette	33 mm	55 mm	8 x 114 mm	
H 334	NF Novantotto	33 mm	55 mm	8 x 114 mm	
H 335	RM Novantotto	33 mm	43 mm	8 x 104 mm	8 x 96 mm
H 338	YK Duemila	33 mm	55 mm	8 x 114 mm	
H 343	JP Duemila	39 mm	50 mm	8 x 104 mm	8 x 96 mm
H 348	DC Duemiladue	33 mm	55 mm	8 x 114 mm	
H 350	CA Duemiladue	33 mm	55 mm	8 x 114 mm	
H 354	FOG Duemilaquattro	40 mm	55 mm	8 x 104 mm	8 x 96 mm
H 356	ZH Duemilacinque	33 mm	55 mm	8 x 104 mm	
H 359	SOM NY Duemilasette	30 mm	60 mm	8 x 114 mm	
H 361	AC4 Duemilasei	40 mm	60 mm	8 x 114 mm	8 x 104 mm
H 364	MB Duemilanove	40 mm	60 mm	8 x 114 mm	8 x 104 mm
H 367	GV Duemilanove	40 mm	60 mm	8 x 114 mm	8 x 104 mm
H 368	CA Duemilanove	40 mm	60 mm	8 x 114 mm	8 x 104 mm
H 369	EG Duemilanove	40 mm	55 mm	8 x 114 mm	8 x 104 mm
H 370	MDF Duemiladieci	30 mm	55 mm	8 x 114 mm	
H 372	EG Duemilaundici	38 mm	48 mm	8 x 104 mm	8 x 96 mm
H 376	GV Duemilaquattordici	40 mm	60 mm	8 x 114 mm	8 x 104 mm
H 377	SL Duemilasedici	40 mm	60 mm	8 x 114 mm	8 x 104 mm
H 378	YP Duemiladiciotto	32 mm	63 mm	8 x 114 mm	8 x 104 mm
H 379	AC Duemilaventi	33 mm	43 mm	8 x 96 mm	
H 380	AC1 Duemilaventi	33 mm	43 mm	8 x 96 mm	
H 381	KAN Duemilaventi	32 mm	63 mm	8 x 114 mm	
H 382	CCD Duemilaventi	32 mm	63 mm	8 x 114 mm	
H 383	PW Duemilaventuno	40 mm	55 mm	8 x 104 mm	
H 384	CR Duemilaventuno	32 mm	63 mm	8 x 114 mm	
H 5008	Himalaya	34 mm	50 mm	8 x 114 mm	
H 5014	Bernina	30 mm	60 mm	8 x 114 mm	
H 5015	K2	30 mm	60 mm	8 x 114 mm	
H 5017	Gottardo	40 mm	60 mm	8 x 114 mm	

**Note:** For the products on slim rosette, the spindle is 10mm shorter than what indicated in the list above.



# List of door thickness for each door lever

## DOOR KNOBS

Article	Series	Thickness from	to	1.3/4" with spindle	1.3/8" with spindle
K 377	SL Duemilasedici	40 mm	60 mm	8 x 114 mm	8 x 104 mm
K 378	YP Duemiladiciotto	32 mm	63 mm	8 x 114 mm	8 x 104 mm
K 383	PW Duemilaventuno	40 mm	60 mm	8 x 114 mm	
K 5301		34 mm	50 mm	8 x 114 mm	
K 5302		34 mm	50 mm	8 x 114 mm	

**Note:** For the products on slim rosette, the spindle is 10mm shorter than what indicated in the list above.



## Certifications

---

# Quality Certifications

Valli&Valli / ASSA ABLOY has obtained the following certifications:





**Prodotto**  
**ification**

**0001-01**

**A S.p.A.**

**to (BO) - IT**

**UNITS**

**it**

**e (MB) - IT**

**WING PRODUCTS**

**ATURE**

**TRADE NAME/S**

**INFORMATIVO ICIM**  
**INFORMATIVE DOCUMENT**

**W**

**B**

**DATA DI SCADENZA**  
**EXPIRING DATE**  
**13/02/2023**

**kt)**

1/3

*Environmental  
Management according to  
UNI EN ISO 14001:2015*

*European Regulation  
EN 1906:2012*

*Quality Management  
according to  
UNI EN ISO 9001:2015*

  
**CARBON  
TRUST**

*Valli&Valli's primary  
factory site, in Renate  
(Italy), has achieved  
verification from the  
Carbon Trust that it  
provides a zero waste  
to landfill operation*



## **General sales terms and conditions**

---



## General sales terms and conditions

All orders are accepted subject to the following Terms and Conditions of Sale. Any terms and/or conditions contained in the Buyer's purchase order or other writing pertaining to such order which are in conflict with or add to or subtract from the following Terms and Conditions of Sale shall not become part of any resulting contract unless expressly accepted in writing by Valli & Valli (U.S.A.) Inc. ("V&V").

### 1. GENERAL INFORMATION

- (a) V&V reserves the right to accept or reject any order for any reason.
- (b) No order is binding on V&V until received in writing and approved by V&V. V&V agrees to sell and Buyer agrees to buy only in accordance with these terms and conditions which are applicable to and binding upon the sale and purchase of every product sold by V&V. No departure from these terms and conditions in any respect whatsoever shall be valid except when in writing and signed by an authorized officer of V&V. Any additions, deletions or other changes to or in an order are subject to the terms and conditions stated herein. No salesman or agent of V&V has the authority to make any changes in V&V's terms and conditions or sale prices.
- (c) V&V shall deliver the products specified on an order within a reasonable time after acceptance of orders, and shall use reasonable efforts to make timely delivery subject to the ability of V&V to ship, at the time and in the quantity specified, contingent upon strikes, floods, fires, accidents, labor or material troubles, product availability, or rules and regulations of the United States or any state, municipal or other lawful authority therein or where V&V's products are manufactured, or other causes beyond the control of V&V, and V&V shall not be liable for damages for failure to make partial or complete shipment or for any delay in making shipments. In no event shall the terms of this provision affect Buyer's obligation to pay for goods sold and delivered.
- (d) The Buyer may not cancel an order without V&V's consent. If V&V is unable to make shipment of specified quantities of its standard products within thirty (30) days of the specified time and so notifies the Buyer, the Buyer may give notice to V&V by telefax confirmed by letter sent registered mail of its intention to cancel that part of the order which remains unshipped at the time of V&V's receipt of such telefax or within fifteen (15) days after the post-marked date of such letter, whereupon such unshipped part of the order shall be cancelled.
- (e) All specifications listed in our Catalog and/or Price List are subject to change without notice including packing, weights, measurements and product designs.

### 2. PRICES

- (a) Prices are quoted, products are sold, and all shipments are made F.O.B. V&V's warehouse, unless otherwise specified. All prices are stated in U.S. currency.
- (b) Each order, or any part thereof, is subject to billing and payment at V&V's prices in effect at the time of shipment.
- (c) V&V reserves the right to change any of the prices of an order up to the date of shipment, upon notice to the Buyer. Any orders upon which prices have been changed which are not confirmed by Buyer within fifteen (15) days of notice being sent shall be cancelled.
- (d) All prices are subject to additional federal, city and state taxes, if applicable.
- (e) Prices, terms and conditions of sale, and trade discounts, if any, are subject to change without prior notice at any time prior to V&V's acceptance of the Buyer's order.

### 3. TERMS OF PAYMENT

- (a) Terms of payment are thirty (30) days net from the date of V&V's invoice and payment is not timely unless actually received by V&V on or before the due date.
- (b) A service and carrying charge of one and one half (1-1/2%) percent per month (annual percentage rate eighteen (18%) percent) will be charged on all invoices outstanding more than thirty-five (35) days. Buyer shall pay all costs and expenses (including reasonable attorney's fees) incurred by V&V in connection with any payments not made when due. V&V reserves the right to stop confirmed shipments to accounts which have invoices over sixty (60) days past due.
- (c) If Buyer fails to pay an invoice at maturity or defaults on or repudiates this or any other agreement with V&V, or becomes insolvent or calls a meeting of its creditors or if a bankruptcy, insolvency, re-organization or arrangement proceeding is commenced by or against Buyer, V&V may (i) cancel this and/or any other contracts with Buyer, and Buyer shall remain liable for any damages to V&V; or (ii) (a) declare all outstanding invoices under this and/or any other contracts immediately due and payable; (b) defer any shipments hereunder; (c) sell all or part of the undelivered goods at private or public sale, at which V&V may become buyer; (d) bill at contract price all or any part of the undelivered goods to Buyer, with delivery to Buyer only after full payment is made; and (e) take possession of delivered but unpaid for goods wherever found without process of law.
- (d) If, at any time, reasonable grounds for insecurity arise with respect to Buyer's performance of its payment obligations to V&V. V&V may demand payment in full for the products or such financial security which in V&V's sole discretion shall be equivalent to the sales price of the products.

### 4. RUSH DELIVERY CHARGES \$ 30.00 NET

Applies to all orders requested to be shipped within 48 hrs.

### DROP SHIP CHARGES \$ 5.00

### 5. SHIPPING AND FREIGHT ALLOWANCE

V&V will ship products in any manner most satisfactory to V&V, based upon convenience, experience and cost. Full freight allowed and prepaid to all points in the continental United States on any shipment equal to or in excess of One Thousand (\$1,000.00) Dollars net invoice value by the carrier of V&V's selection.

No freight allowance on shipments of less than One Thousand (\$1,000.00) Dollars net invoice value. A One (\$1.50) Dollar fifty cent service charge per shipment shall be applied for freight handling and insurance coverage.

### 6. RETURNS

A written request must be received by V&V within 90 days from the date of the receipt of the order and approved by an authorized officer of V&V in writing prior to the return of any products. Returns must be made within 90 days of RGA approval. Any approved returns shall be delivered at Buyers expense freight prepaid to any point designated by V&V and a minimum of thirty-five (35%) percent handling charge will apply. A handling fee will be charged on all returned goods. All returned goods must be returned in the original factory sealed cartons and must be in saleable condition. Merchandise may be returned for credit toward future orders only. Credit must be applied within one (1) year of the date of issuance.

### 7. CLAIMS

Risks of theft, loss or damage to, or destruction of, the products shall pass to the Buyer when the products are placed in the possession of the first carrier at V&V's place of shipment. Claims for damage, loss in transit and delay in delivery must be made to the carrier by the Buyer. All other claims must be reported promptly within fifteen (15) days of receipt of merchandise. Replacement deliveries shall be made or returns accepted only if V&V's investigation supports the claim. V&V's liability with respect to substantiated claims shall be limited to either replacing or accepting the return of the products with refund of the original purchase price.



## General sales terms and conditions

### 8. LIMITED WARRANTY

V&V warrants to third party purchasers that V&V products shall be free from defects in material or workmanship for a period of one (1) year following their purchase from an authorized V&V dealer. V&V's sole obligation under this warranty shall be to repair or replace products which V&V determines to be defective and which are returned to V&V with proper documentation during the warranty period, shipping charges prepaid to 100 Commerce Way, Suite 2, Hackensack, NJ 07601.

V&V DOES NOT ASSUME ANY WARRANTY RESPONSIBILITY FOR DAMAGES DUE TO CONDITIONS OVER WHICH V&V HAS NO CONTROL, INCLUDING BUT NOT LIMITED TO IMPROPER INSTALLATION, IMPACT, TAMPERING OR ABUSE. FINISHES CANNOT BE GUARANTEED FROM TARNISHING, EXCESSIVE WEAR, OR DETERIORATION DUE TO EXPOSURE TO ATMOSPHERIC CONDITIONS OVER WHICH V&V HAS NO CONTROL. V&V MAKES NO OTHER WARRANTIES, EXPRESS OR IMPLIED, WITH RESPECT TO THE PRODUCTS DELIVERED, INCLUDING WITHOUT LIMITATION, ANY WARRANTY OF MERCHANTABILITY OR FITNESS FOR A PARTICULAR PURPOSE.

IN NO EVENT SHALL V&V BE LIABLE FOR ANY SPECIAL, INDIRECT, INCIDENTAL OR CONSEQUENTIAL DAMAGES INCLUDING, BUT NOT LIMITED TO, LOSS OF PROFITS OR DAMAGES TO BUSINESS OR BUSINESS RELATIONS.

THIS WARRANTY IS IN LIEU OF ALL OTHER WARRANTIES EXPRESS OR IMPLIED, STATUTORY OR OTHERWISE AND IS LIMITED TO THE DURATION OF THE WARRANTY PERIOD OF THIS EXPRESS WARRANTY. SOME STATES DO NOT ALLOW LIMITATION ON HOW LONG AN IMPLIED WARRANTY LASTS OR THE EXCLUSION OR LIMITATION OF INCIDENTAL OR CONSEQUENTIAL DAMAGES SO THE ABOVE LIMITATIONS OR EXCLUSIONS MAY NOT APPLY TO BUYER. THIS WARRANTY GIVES YOU SPECIFIC LEGAL RIGHTS AND BUYER MAY ALSO HAVE OTHER RIGHTS WHICH VARY FROM STATE TO STATE.

### 9. GOVERNING LAWS

Any controversy or claim arising out of or relating to the purchase or sale of V&V's products shall be construed in accordance with the laws of the State of New York and shall be settled by arbitration in the City, Country and State of New York in accordance with the current Commercial Arbitration Rules of the American Arbitration Association and judgment upon the award rendered may be entered in any court of competent jurisdiction.

### 10. SIZES AND DIMENSIONS

Conversion from metric to U.S. measurements is approximate. Refer to product for exact metric sizing.

### 11. PROJECTS

All project orders require a down payment. Freight FOB New Jersey Warehouse.

### 12. DISCONTINUED

We may discontinue products or alter specifications at any time without prior notification or obligation. Product will continue to be available as long as inventory remains, after which the product will be discontinued. This program is intended to help our customers anticipate future needs and to avoid bidding or taking orders on parts which may not be available in sufficient quantities when needed.

### 13. INDUSTRY STANDARD

The prevailing industry standard is that the special order items, electrical products and specialty keyed products may not be returned.

### 14. CARE & MAINTENANCE

Door handles and their accessories are designed to open and close doors. They represent a complimentary element of the door, together with the frame, hinges, door panel, lock and cylinder.

Opening and closing a door with a handle requires certain actions, such as opening a security bolt.

Only in certain cases, such as on emergency doors, the handles serves the function of working the lock by lowering or pushing it.

Window handles too are to be considered only a complimentary part of the window. It is normally the opening system of the window that determines the hardware required and consequently the mechanism required for the working of the window handle.

Door handles, pull handles and window handles are often incorrectly used, damaging the product and the quality standard defined by the producer.

Common errors include:

The use of the handle as a support or hook for objects which may be excessively heavy.

The use of the handle as a plaything by children.

The use of the handle as a doorstop against the wall.

Valli&Valli products do not require excessive maintenance. For care and cleaning, except in those cases where a specific product is recommended for certain finishes, Valli&Valli recommends the use of just a soft dry cloth.

To ensure correct installation, the instructions contained in the box should be followed.

If necessary consult the retailer or specialized personnel.

In the case of products in glass or porcelain together with brass, it should be remembered that these fragile materials are liable to break if used incorrectly.

Valli&Valli recommends the use of doorstops fixed to the floor or the wall close to the door or its handle.

On all products with a grab screw Valli&Valli recommends the use of a retaining compound.

It is also advisable to check the position and tightness of all fixing elements at regular intervals.

The user/purchaser of the product should ask the retailer for instructions regarding the correct installation, care and maintenance of the product.

Valli&Valli products are subject to a continual process of development and updating, and production is constantly monitored by Valli&Valli Quality Assurance.

Most Valli&Valli products are "tools" for opening and closing doors and windows.

Inevitably, as with all artifacts, depending on the material of which they are made and where they are made and where they are used, they are subject to wear and then passing of time.

Brass, an alloy subject to oxidation, has to be covered with a protective coating if its appearance is to remain unchanged over time.

Care should be taken during use and maintenance, as improper use or poor maintenance could damage the protective coating, permitting corrosion and consequently causing an anti-aesthetic appearance.

Stainless steel is generally considered to be indestructible.

However, even this material can show the occasional scratch or spot of rust.

Such rust-spots are so-called "surface ruse", and can be removed using an appropriate cleaner, available from specialized retailers.

The manufacturer cannot be held responsible for damage due to normal wear and tear, incorrect treatment, installation or maintenance or non-observance of the above warnings.





#### **Headquarters/Showroom**

##### **Valli&Valli (U.S.A.) Inc.**

22 West 21st Street  
6th Floor  
New York, NY 10010  
Tel. (212) 326 8811  
Fax (212) 326 8816  
Toll Free (877) 326 2565  
E-mail: sales@vallivalli-us.com

#### **Warehouse**

##### **Valli&Valli (U.S.A.) Inc.**

100 Commerce Way, Suite 2  
Hackensack, NJ 07601  
Tel. (973) 249 0085  
Fax (973) 249 0135

#### **Commercial offices in Italy**

##### **Domestic Sales**

Tel. +39 0362 982271  
Fax +39 0362 982235  
valli.italia@vallievalli.com

##### **Export Sales**

Tel. +39 0362 982260  
Fax +39 0362 982214  
valli.export@vallievalli.com

#### **Showroom**

New York  
22 West 21st Street  
6th Floor  
New York, NY 10010  
Tel. (212) 326 8811  
Fax (212) 326 8816

#### **Factory**

Valli&Valli  
Via Concordia, 16  
20838 Renate (MB) Italy





**Fusital**  
Maniglie d'autore

**Headquarters/Showroom**

Valli&Valli (U.S.A.) Inc.

22 West 21st Street,

6th Floor

New York, NY 10010

Tel. (212) 326 8811

Fax (212) 326 8816

Toll Free (877) 326 2565

[sales@vallivalli-us.com](mailto:sales@vallivalli-us.com)

**Warehouse**

Valli&Valli (U.S.A.) Inc.

100 Commerce Way,

Suite 2

Hackensack, NJ 07601

Tel. (973) 249 0085

Fax (973) 249 0135

[www.vallivalli-us.com](http://www.vallivalli-us.com)