

WELCOME



IT IS OUR SINCERE PLEASURE TO WELCOME YOU TO THE CLASSIC BRASS FAMILY. CLASSIC BRASS IS LOCATED IN WESTERN NEW YORK — HOME TO GENERATIONS OF SKILLED AMERICAN CRAFTSMAN WHO TAKE PRIDE IN EVERY PIECE OF HARDWARE WE PRODUCE IN OUR JAMESTOWN FACTORY.

Every piece of our quality hardware is finished by hand, requiring intricate steps and processes to create our 33 unique and stunning finishes. The detail, scale and range of flexibility is unmatched in the marketplace, and our team is honored to deliver exceptional customer service to our valued partners.

It is our goal to enhance your cabinetry by adding our hardware. We guarantee our solid brass hardware will provide a defining touch of elegance and beauty to any room or project.

We appreciate the opportunity to be considered for your hardware selection and look forward to adding you to our family of customers.

Chris Creighton
President/CEO

TERMS & POLICIES

TERMS

1% 10 days – NET 30. All invoices past 30 days are subject to a past due charge of 1.5% per month.

Past due accounts will be placed on “HOLD”. No shipments will be made until the account is brought within terms.

FREIGHT

Ground freight will be prepaid on all cabinet hardware orders over \$500/net. All other shipments are F.O.B. — Jamestown, New York.

Drop shipments are made at no additional charge.

RETURNED GOODS POLICY

All products requiring warranty work must be pre-authorized by Classic Brass prior shipping the material to our factory. A Return Goods Authorization (RGA) must be issued prior to any hardware being returned and properly noted on the shipment carton and/or return paperwork.

Ship To:

Classic Brass Inc.
Attn: RGA Department
2051 Stoneman Circle
Lakewood, NY 14750
716.763.1400

Products will only be accepted for return within 60 days of invoice date

Due to the custom nature of our cabinet hardware products, a 25% restocking fee will be applied to all returns other than defective merchandise.

SHIPMENT DISCREPANCY

Any discrepancy as to the quantity or accuracy of the products shipped must be reported with ten days of receipt.

OUR PROMISE

The Classic Brass family take a great deal of pride in the products produced by our American craftsman. We offer a lifetime guarantee on the material and workmanship of our products. Our handcrafted WAX finishes performed on our solid brass or bronze products as known as a “living finish” which means it will change with time, touch, climate and care techniques. Our finishes shipped with a lacquer coating are guaranteed for a period of one year from date of receipt. We will refinish at our expense all products returned that we deem to be a defective finish.

Due to the fact each product will be exposed to a varying set of conditions, we do not warranty the finish of our products except as stated above. Repeated handling and use will result in an inherently beautiful and graceful finish desired by the finest residences across the world.

We require the original Purchase Order No. to receive a Return Goods Authorization.

Classic Brass will repair or replace the defective product or parts that fall within these guidelines. If material is determined to be defective, the limit of damage is the price of the defective material. Classic Brass will not be liable for any labor charges regarding the removal or reinstallation of the products, transportation costs or associated handling expense related to the product. Defects or damage deemed to have been caused by accident, misuse, abuse or improper installation are not covered by this warranty. Surface scratches and wear are not manufacturing defects but are indicative of normal wear and tear. Classic Brass will be the sole interpreter of the above warranty.

CONTACT US

Plant Address 2051 Stoneman Circle, Lakewood, NY 14750

Mailing Address P.O. Box 3563, Jamestown, NY 14702-3563

Phone (800) 869.3173 / (716) 763.1400

Fax (800) 215.2019 / (716) 763.1500

Email sales@classic-brass.com

Web classic-brass.com



FINISH CHART

FINISH NAME	LACQUER (STANDARD)	WAX (STANDARD)	NO TOP COAT	POWDER COAT
<i>SOLID BRASS LEVEL 1</i>				
ANTIQUE BRASS (AB)	•			
ANTIQUE BURNISHED BRASS (ABB)		•		
BURNISHED BRASS (BB)		•		
OIL RUBBED BRONZE (BZ)	•			
KENSINGTON (KN)		•		
POLISHED ANTIQUE (PA)	•			
POLISHED ANTIQUE — NO LACQUER (PANL)		•		
POLISHED BRASS (PB)	•			
POLISHED BRASS — NO LACQUER (PBNL)			•	
REVERE BRASS (RB)		•		
REVERE TARNISHED (RT)		•		
SATIN BRASS (SB)	•			
SATIN BRASS — NO LACQUER (SBNL)		•		
SATIN TARNISHED (STN)		•		
TARNISHED (TN)		•		
WEATHERED BRASS (WB)	•			
WEATHERED BRONZE (WZ)	•			
<i>SOLID BRASS LEVEL 2</i>				
ANTIQUE BURNISHED NICKEL (ABN)		•		
ANTIQUE NICKEL (AN)	•			
BURNISHED NICKEL (BN)		•		
MATTE BLACK (MB)				•
POLISHED CHROME (PC)			•	
POLISHED NICKEL (PN)			•	
REVERE NICKEL (RN)		•		
SATIN NICKEL (SN)	•			
WEATHERED ANTIQUE NICKEL (WA)	•			
WEATHERED COPPER (WC)	•			
WEATHERED NICKEL (WN)	•			
<i>SOLID BRASS LEVEL 3</i>				
ANTIQUE POLISHED SILVER (APS)		•		
POLISHED SILVER (PS)		•		
SATIN SILVER (SS)		•		
<i>SOLID BRONZE</i>				
AGED IRON (AI)	•			
AGED SILVER (AS)	•			
AGED BRONZE (AZ)	•			
MATTE BLACK (MB)				•
NATURAL BRONZE (NB)			•	
STERLING (ST)	•			

FINISH TYPES

<p>SOLID BRASS LEVEL 1</p>						
	ANTIQUE BRASS (AB)	ANTIQUE BURNISHED BRASS (ABB)	BURNISHED BRASS (BB)	OIL RUBBED BRONZE (BZ)	KENSINGTON (KN)	
						
	POLISHED ANTIQUE (PA)	POLISHED ANTIQUE NO LACQUER (PANL)	POLISHED BRASS (PB)	POLISHED BRASS NO LACQUER (PBNL)	REVERE BRASS (RB)	REVERE TARNISHED (RT)
						
	SATIN BRASS (SB)	SATIN BRASS NO LACQUER (SBNL)	SATIN TARNISHED (STN)	TARNISHED (TN)	WEATHERED BRASS (WB)	WEATHERED BRONZE (WZ)
<p>SOLID BRASS LEVEL 2</p>						
	ANTIQUE BURNISHED NICKEL (ABN)	ANTIQUE NICKEL (AN)	BURNISHED NICKEL (BN)	MATTE BLACK (MB)	POLISHED CHROME (PC)	
						
	POLISHED NICKEL (PN)	REVERE NICKEL (RN)	SATIN NICKEL (SN)	WEATHERED ANTIQUE NICKEL (WA)	WEATHERED COPPER (WC)	WEATHERED NICKEL (WN)

SOLID BRASS LEVEL 3



ANTIQUE POLISHED SILVER (APS)



POLISHED SILVER (PS)



SATIN SILVER (SS)

PRICE ON REQUEST



POLISHED GOLD (PG)



SATIN GOLD (SG)

SOLID BRONZE



AGED IRON (AI)



AGED SILVER (AS)



AGED BRONZE (AZ)



MATTE BLACK (MB)



NATURAL BRONZE (NB)



STERLING (ST)

HOW TO ORDER

1. If WAX is required on a standard finish which is lacquered...Add “-WAX” to finish code (example: AB - WAX)
2. If LACQUER is required on a standard finish that is waxed...Add “-LACQUER” to finish code (example: KN - LACQUER). We will send a sample of the finish for your approval.

CUSTOM FINISHES AVAILABLE

Contact us to discuss your requirements.

REMEMBER

1. Wax finish is synonymous with ‘living’ finish and will change and enhance the appearance of the finish over time depending on the location and use.
2. When in doubt, please order a sample to confirm your client’s acceptance.

ADDITIONAL INFORMATION

CAPABILITIES

Classic Brass hardware is finished to order. Our American craftsmen possess years of experience, incredible skill and the artistic eye to create distinctive finishes that are recognized throughout the industry. Art meets science with a combination of highlighting, wax and plating techniques to create rich color tones and hues. You can choose from a wide range of standard finishes, variation of standard finishes or custom finishes to match your unique home and style.

CUSTOMIZATION



HAND HAMMERING

We offer hand hammering as an additional detail for your hardware pieces. Our craftsmen hand hammer this peened texture on the surface of each piece to give a unique finish and touch of flair.



MONOGRAMMING

Whether it's initials, a family crest or company logo, we'll help you leave a mark that lasts. Classic Brass offers monogrammed hardware to add a personal, elegant touch to your home or business.

CARE FOR WAX FINISHES

Apply a clear furniture paste wax and let dry. Using a soft cloth, remove the dried wax and shine to level of desired brightness. A soft bristle brush is recommended to remove any excess wax from low ground or detail (i.e. coin, rope, etc) that may be hard to remove with a cloth.

For best results, paste wax should be applied every 6 months.

**On larger orders, please find a complimentary 1oz. canister of wax enclosed.*

CARE FOR LACQUER FINISHES

For best results and a lasting finish, we recommend that you maintain lacquer coated products with a mild soap. Rinse and dry thoroughly.



CABINET KNOBS



3070



3071



3072

PRODUCT NUMBER	A	B	C
3070 Knob	1"	7/8"	5/8"
3071 Knob	1-1/4"	1-1/8"	43/64"
3072 Knob	1-1/2"	1-11/32"	13/16"

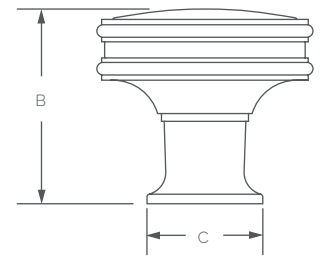
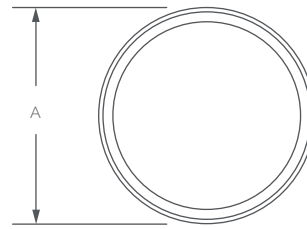

3074



3075

PRODUCT NUMBER	A	B	C
3074 Knob - Coin	1-1/4"	1-1/8"	43/64"
3075 Knob - Coin	1-1/2"	1-11/32"	13/16"

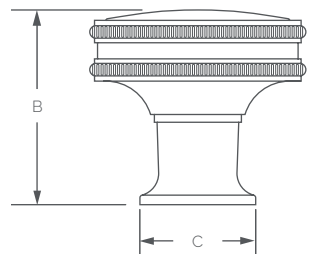
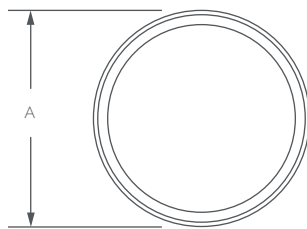

CABINET KNOBS



3077



3078

PRODUCT NUMBER	A	B	C
3077 Knob - Rope	1-1/4"	1-1/8"	43/64"
3078 Knob - Rope	1-1/2"	1-11/32"	13/16"

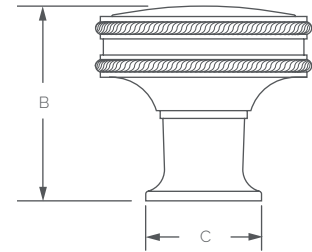
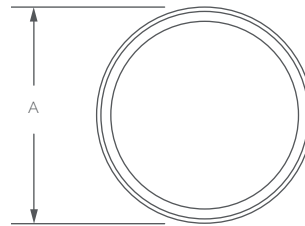

3080



3081



3082

PRODUCT NUMBER	A	B	C
3080 Knob	1"	27/32"	3/8"
3081 Knob	1-1/4"	1-1/8"	15/32"
3082 Knob	1-1/2"	1-11/32"	9/16"

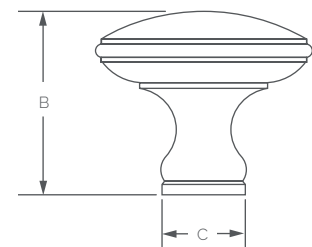
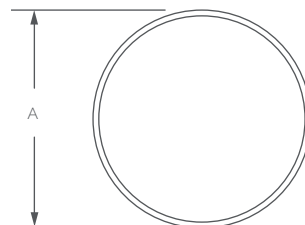

CABINET KNOBS



3084



3085

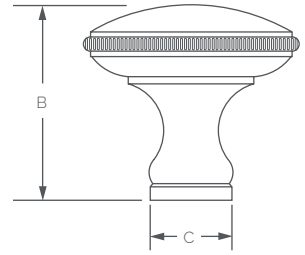
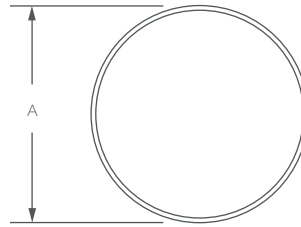

PRODUCT NUMBER	A	B	C
3084 Knob - Coin	1-1/4"	1-1/8"	15/32"
3085 Knob - Coin	1-1/2"	1-11/32"	9/16"



3087



3088

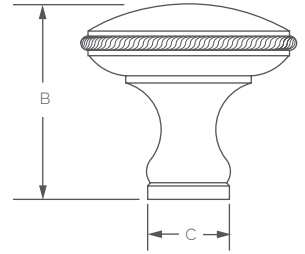
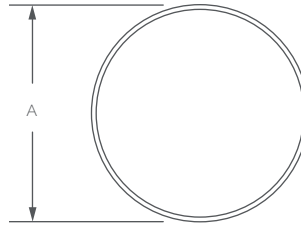

PRODUCT NUMBER	A	B	C
3087 Knob - Rope	1-1/4"	1-1/8"	15/32"
3088 Knob - Rope	1-1/2"	1-11/32"	9/16"

CABINET KNOBS



3001



3002

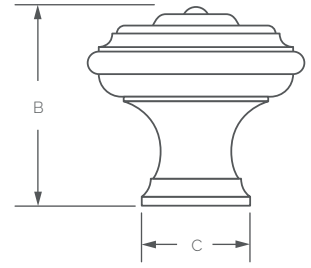
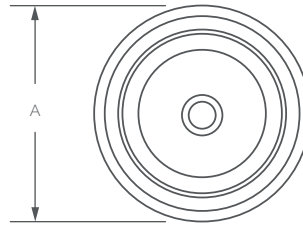

PRODUCT NUMBER	A	B	C
3001 Knob	1-1/4"	1-5/32"	5/8"
3002 Knob	1-1/2"	1-3/8"	3/4"



3004



3005

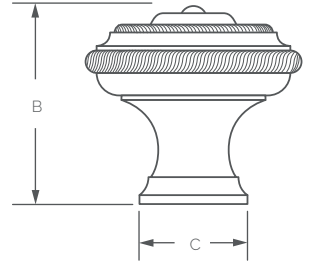
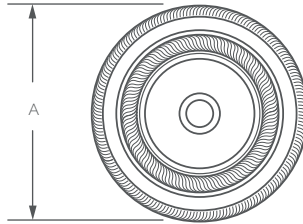

PRODUCT NUMBER	A	B	C
3004 Knob - Double Rope	1-1/4"	1-5/32"	5/8"
3005 Knob - Double Rope	1-1/2"	1-3/8"	3/4"



3007



3008

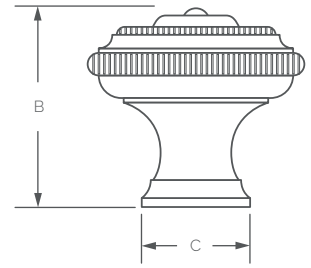
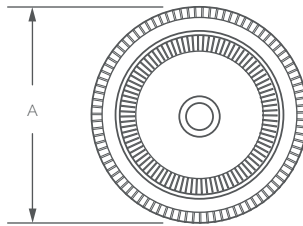

PRODUCT NUMBER	A	B	C
3007 Knob - Double Coin	1-1/4"	1-5/32"	5/8"
3008 Knob - Double Coin	1-1/2"	1-3/8"	3/4"

CABINET KNOBS



3011



3012

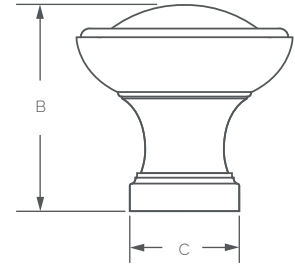
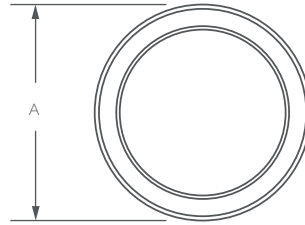

PRODUCT NUMBER	A	B	C
3011 Knob	1-1/4"	1-3/16"	5/8"
3012 Knob	1-1/2"	1-7/16"	3/4"



3013



3014

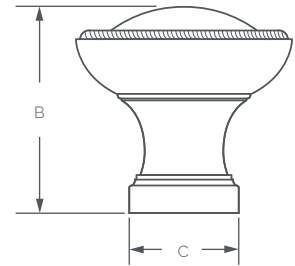
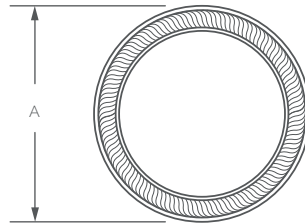

PRODUCT NUMBER	A	B	C
3013 Knob - Rope	1-1/4"	1-3/16"	5/8"
3014 Knob - Rope	1-1/2"	1-7/16"	3/4"



3015



3016

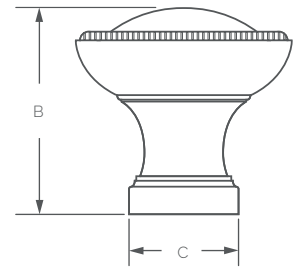
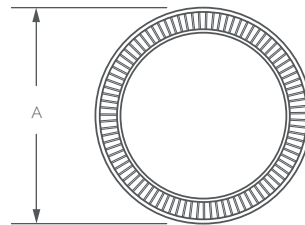

PRODUCT NUMBER	A	B	C
3015 Knob - Coin	1-1/4"	1-3/16"	5/8"
3016 Knob - Coin	1-1/2"	1-7/16"	3/4"

CABINET KNOBS



3022



3023

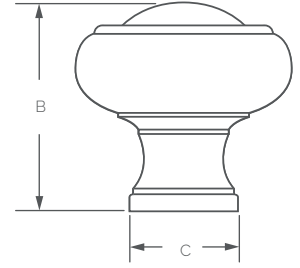
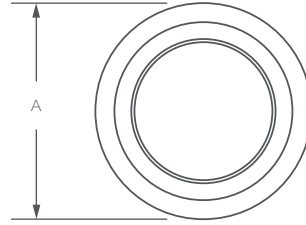

PRODUCT NUMBER	A	B	C
3022 Knob	1-1/4"	1-7/32"	5/8"
3023 Knob	1-1/2"	1-7/16"	3/4"



3024



3025

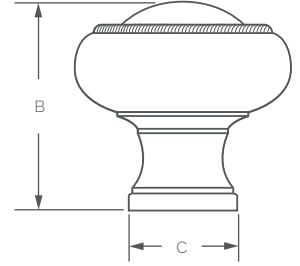
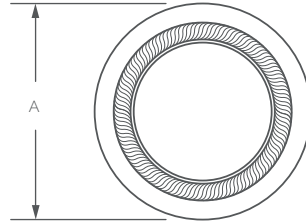

PRODUCT NUMBER	A	B	C
3024 Knob - Rope	1-1/4"	1-7/32"	5/8"
3025 Knob - Rope	1-1/2"	1-7/16"	3/4"



3026



3027

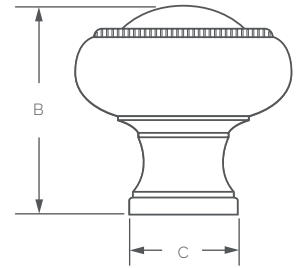
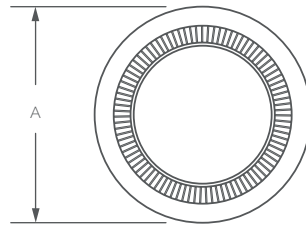

PRODUCT NUMBER	A	B	C
3026 Knob - Coin	1-1/4"	1-7/32"	5/8"
3027 Knob - Coin	1-1/2"	1-7/16"	3/4"

CABINET KNOBS



3033



3034

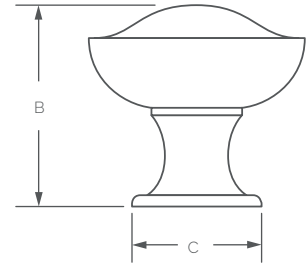
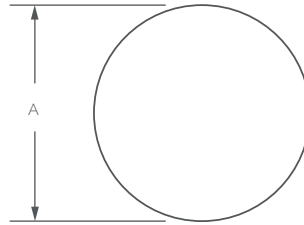

PRODUCT NUMBER	A	B	C
3033 Knob	1-1/4"	1-3/16"	3/4"
3034 Knob	1-1/2"	1-7/16"	29/32"



3042



3043

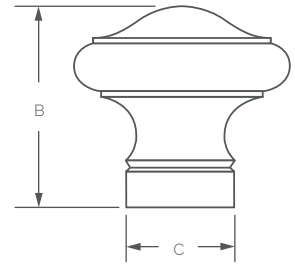
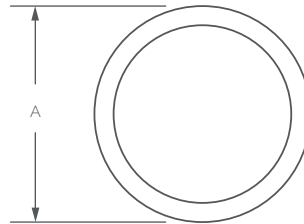

PRODUCT NUMBER	A	B	C
3042 Knob	1-1/4"	1-5/32"	5/8"
3043 Knob	1-1/2"	1-13/32"	3/4"



3057



3058

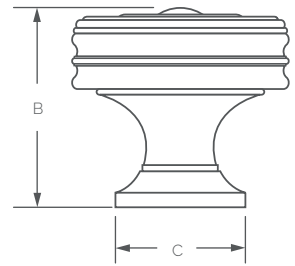
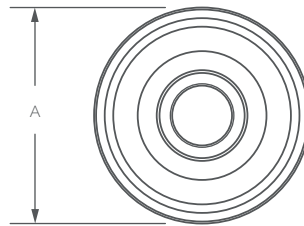

PRODUCT NUMBER	A	B	C
3057 Knob	1-1/4"	1-5/32"	3/4"
3058 Knob	1-1/2"	1-3/8"	29/32"

CABINET KNOBS



3061



3063

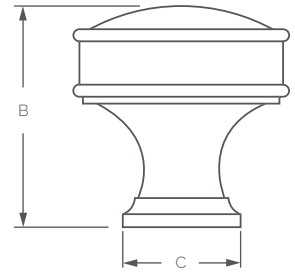
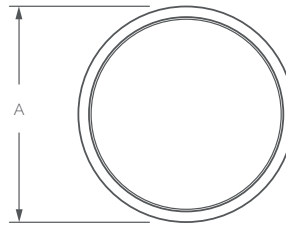

PRODUCT NUMBER	A	B	C
3061 Knob	1-1/4"	1-9/32"	11/16"
3063 Knob	1-1/2"	1-1/2"	13/16"



3064



3066

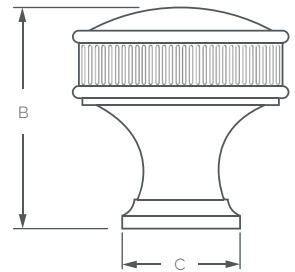
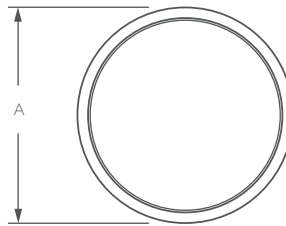

PRODUCT NUMBER	A	B	C
3064 Knob - Inset Coin	1-1/4"	1-9/32"	11/16"
3066 Knob - Inset Coin	1-1/2"	1-1/2"	13/16"



3067



3069

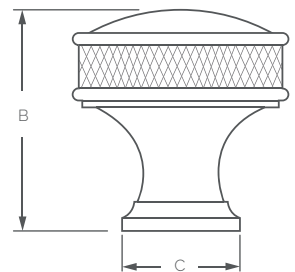
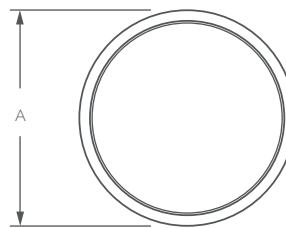

PRODUCT NUMBER	A	B	C
3067 Knob - Inset Cross Hatch	1-1/4"	1-9/32"	11/16"
3069 Knob - Inset Cross Hatch	1-1/2"	1-1/2"	13/16"

CABINET PULLS



3306

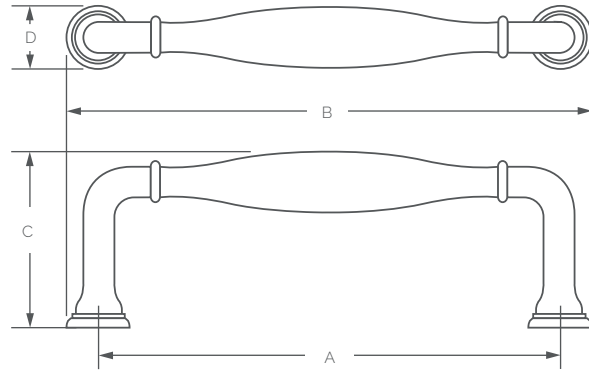

PRODUCT NUMBER	A	B	C	D
3304 Pull	4"	4-9/16"	1-9/16"	9/16"
3306 Pull	6"	6-9/16"	1-9/16"	9/16"
3308 Pull	8"	8-9/16"	1-5/8"	9/16"
3311 Pull	12"	12-9/16"	1-5/8"	9/16"
3317 Pull	18"	18-9/16"	1-5/8"	9/16"
3312 Appliance Pull	12"	12-31/32"	2-1/2"	1"
3318 Appliance Pull	18"	19"	2-11/16"	1"

REMEMBER

Appliance pulls are available as B-T-B and single sided applications.



3406

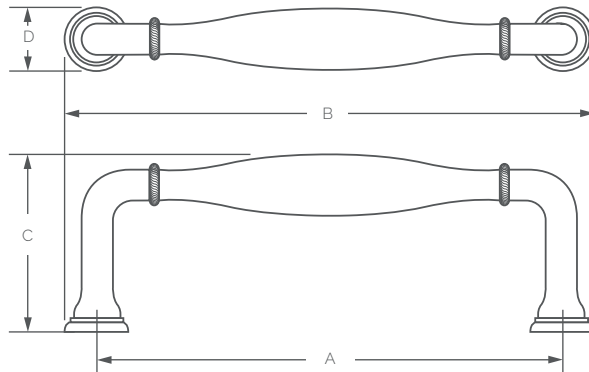

PRODUCT NUMBER	A	B	C	D
3404 Pull - Rope	4"	4-9/16"	1-9/16"	9/16"
3406 Pull - Rope	6"	6-9/16"	1-9/16"	9/16"
3408 Pull - Rope	8"	8-9/16"	1-5/8"	9/16"
3411 Pull - Rope	12"	12-9/16"	1-5/8"	9/16"
3417 Pull - Rope	18"	18-9/16"	1-5/8"	9/16"
3412 Appliance Pull - Rope	12"	12-31/32"	2-1/2"	1"
3418 Appliance Pull - Rope	18"	19"	2-11/16"	1"

REMEMBER

Appliance pulls are available as B-T-B and single sided applications.

CABINET PULLS



3506

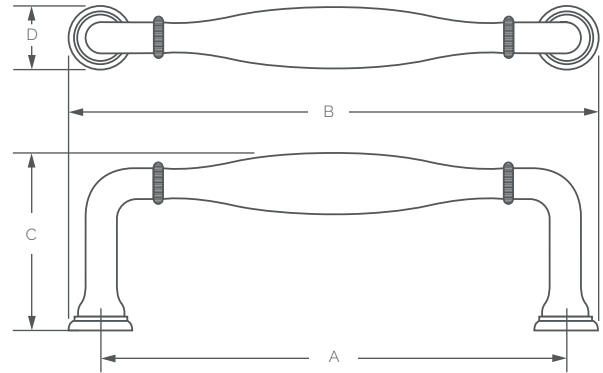

PRODUCT NUMBER	A	B	C	D
3504 Pull - Coin	4"	4-9/16"	1-9/16"	9/16"
3506 Pull - Coin	6"	6-9/16"	1-9/16"	9/16"
3508 Pull - Coin	8"	8-9/16"	1-5/8"	9/16"
3511 Pull - Coin	12"	12-9/16"	1-5/8"	9/16"
3517 Pull - Coin	18"	18-9/16"	1/5/8"	9/16"
3512 Appliance Pull - Coin	12"	12-31/32"	2-1/2"	1"
3518 Appliance Pull - Coin	18"	19"	2-11/16"	1"

REMEMBER

Appliance pulls are available as B-T-B and single sided applications.

BACKPLATES

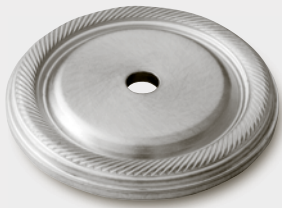

1840

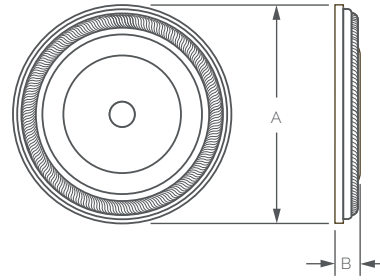

PRODUCT NUMBER	A	B
1840 Backplate - Rope	1-5/8"	3/16"



1847

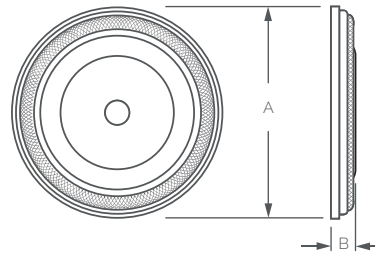

PRODUCT NUMBER	A	B
1847 Backplate - Cross Hatch	1-5/8"	3/16"



1848

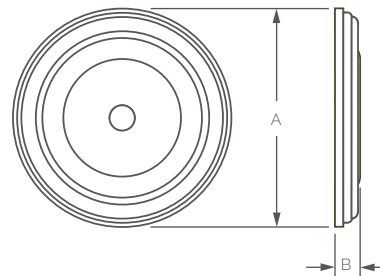

PRODUCT NUMBER	A	B
1848 Backplate	1-5/8"	3/16"

BACKPLATES



1849

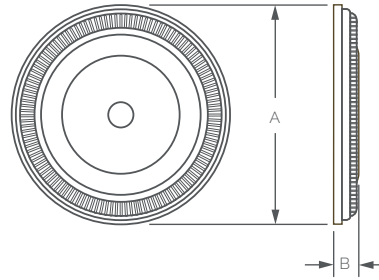

PRODUCT NUMBER	A	B
1849 Backplate - Coin	1-5/8"	3/16"



CABINET KNOBS



1018

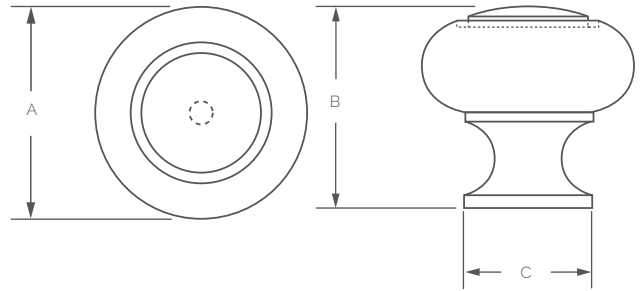

PRODUCT NUMBER	A	B	C
1018 Knob	1-1/4"	1-3/16"	3/4"



1019

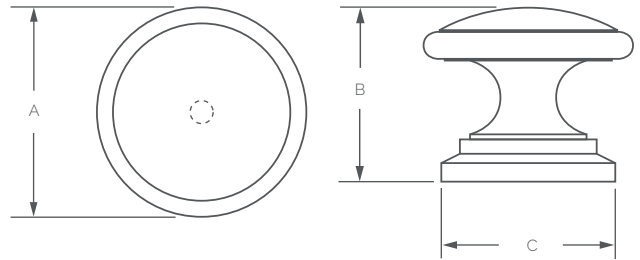

PRODUCT NUMBER	A	B	C
1019 Knob	1-1/4"	1"	1"



1151

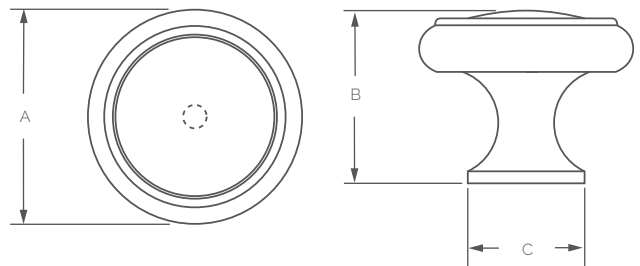

PRODUCT NUMBER	A	B	C
1151 Knob	1-1/4"	1"	11/16"

CABINET KNOBS



1152

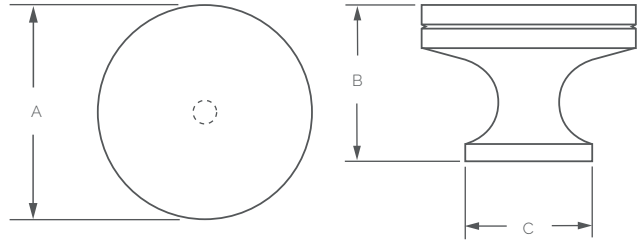

PRODUCT NUMBER	A	B	C
1152 Knob	1-1/4"	29/32"	3/4"



1154

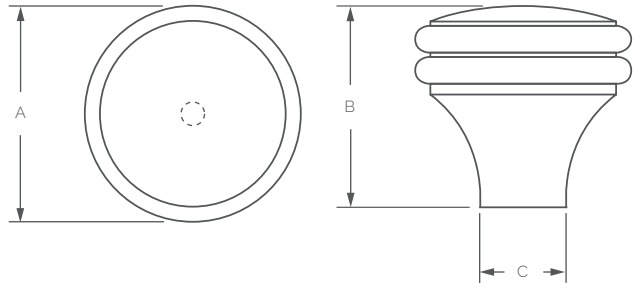

PRODUCT NUMBER	A	B	C
1154 Knob	1-1/4"	1-3/16"	1/2"



1575

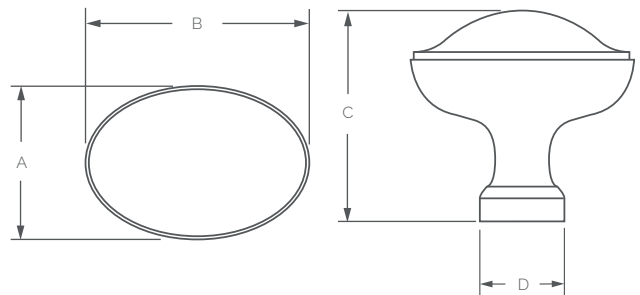

PRODUCT NUMBER	A	B	C	D
1575 Oval Knob	15/16"	1-5/16"	1-1/4"	9/16"

CABINET KNOBS



1196



1195

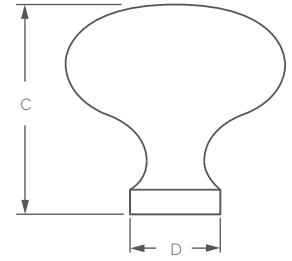
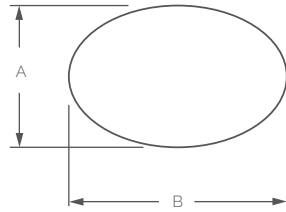

PRODUCT NUMBER	A	B	C	D
1196 Oval Knob	3/4"	1-7/32"	1-1/4"	9/16"
1195 Oval Knob	7/8"	1-5/16"	1-1/4"	9/16"



1832



1834

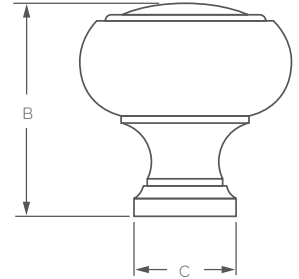
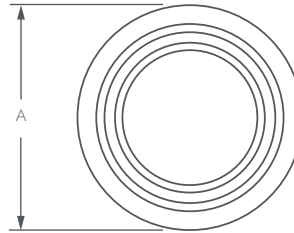

PRODUCT NUMBER	A	B	C
1832 Knob	1-1/4"	1-11/32"	5/8"
1834 Knob	1-1/2"	1-1/2"	3/4"



1843



1846

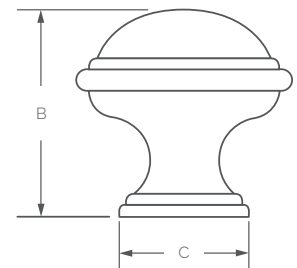
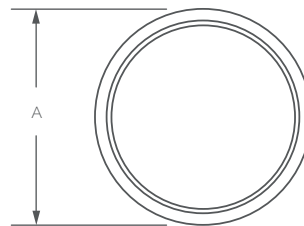

PRODUCT NUMBER	A	B	C
1843 Knob	1-1/4"	1-1/8"	3/4"
1846 Knob	1-1/2"	1-7/16"	13/16"

CABINET KNOBS



1837



1838

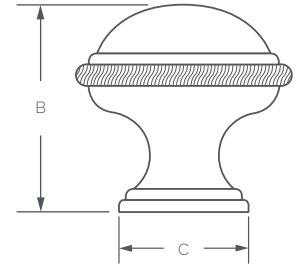
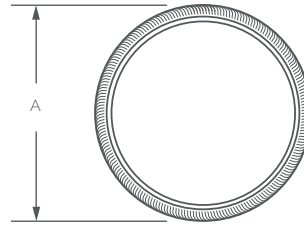

PRODUCT NUMBER	A	B	C
1837 Knob - Rope	1-1/4"	1-1/8"	3/4"
1838 Knob - Rope	1-1/2"	1-7/16"	13/16"



1841



1842

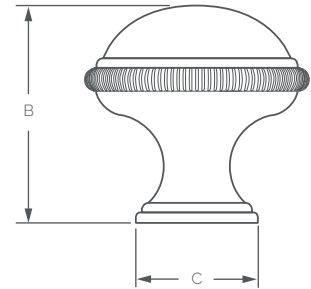
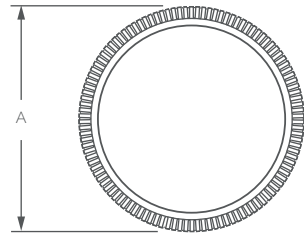

PRODUCT NUMBER	A	B	C
1841 Knob - Coin	1-1/4"	1-1/8"	3/4"
1842 Knob - Coin	1-1/2"	1-7/16"	13/16"



1844



1845

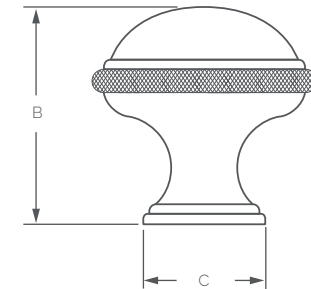
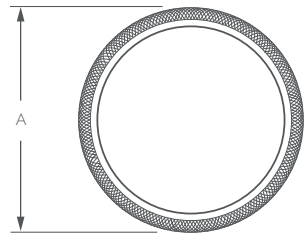

PRODUCT NUMBER	A	B	C
1844 Knob - Cross Hatch	1-1/4"	1-1/8"	3/4"
1845 Knob - Cross Hatch	1-1/2"	1-7/16"	13/16"

CABINET KNOBS



1852



1854

PRODUCT NUMBER	A	B	C
1852 Knob	7/8"	1"	5/8"
1854 Knob	1-1/8"	1-1/4"	13/16"

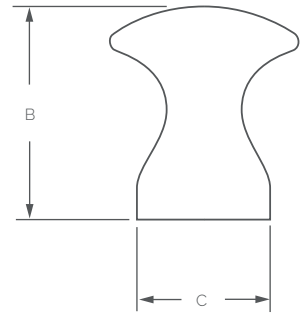
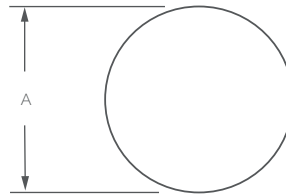

1057



1145



1146

PRODUCT NUMBER	A	B	C
1057 Knob	1-1/8"	7/8"	11/16"
1145 Knob	1-1/4"	15/16"	5/8"
1146 Knob	1-1/2"	1-5/32"	3/4"

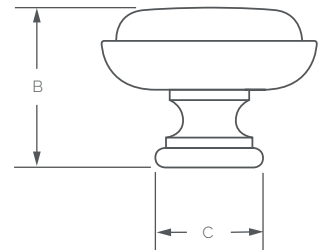
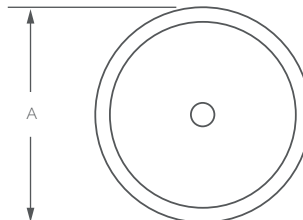

CABINET KNOBS



1003



1164



1165

PRODUCT NUMBER	A	B	C
1003 Knob	1-1/8"	7/8"	3/4"
1164 Knob	1-1/4"	15/16"	3/4"
1165 Knob	1-1/2"	1-1/8"	29/32"

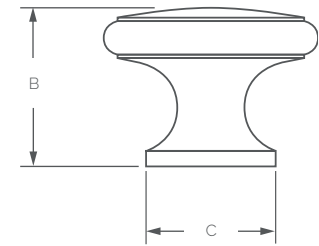
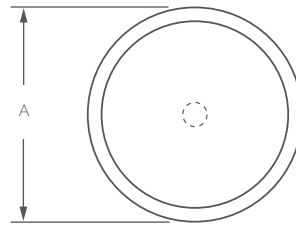

1169



1170



1171

PRODUCT NUMBER	A	B	C
1169 Knob	31/32"	11/16"	5/8"
1170 Knob	1-5/32"	13/16"	11/16"
1171 Knob	1-3/8"	31/32"	3/4"

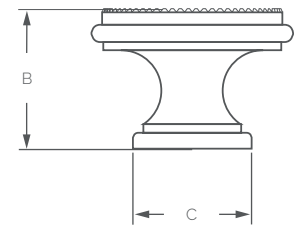
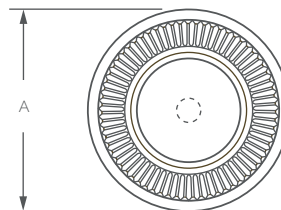

CABINET KNOBS



PRODUCT NUMBER	A	B	C
1047 Knob	1"	7/8"	11/16"
1048 Knob	1-3/8"	1-1/16"	7/8"
1049 Knob	1-1/4"	1"	3/4"
1050 Knob	1-1/2"	1-1/8"	1"

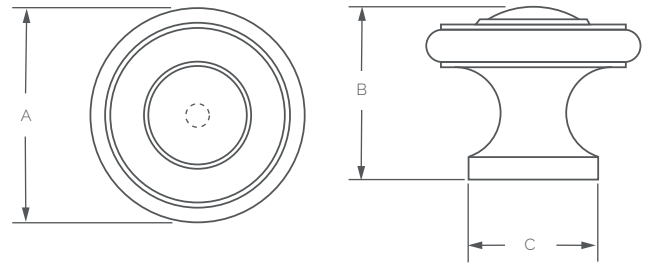

PRODUCT NUMBER	A	B	C
1052 Knob	3/4"	5/8"	7/16"
1053 Knob	1"	7/8"	19/32"
1055 Knob	1-1/4"	1"	3/4"
1056 Knob	1-1/2"	1-1/16"	7/8"

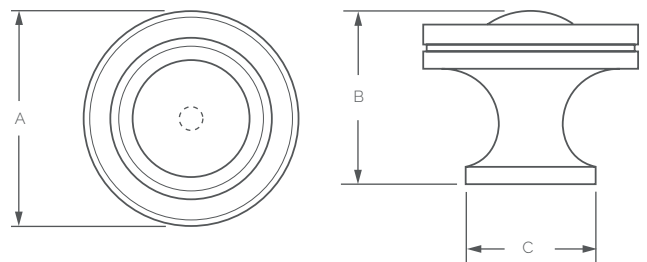

CABINET KNOBS



PRODUCT NUMBER	A	B	C
1862 Knob	1"	13/16"	11/16"
1864 Knob	1-1/4"	7/8"	15/16"
1866 Knob	1-1/2"	15/16"	1-1/8"
1868 Knob	2"	1"	1-3/8"

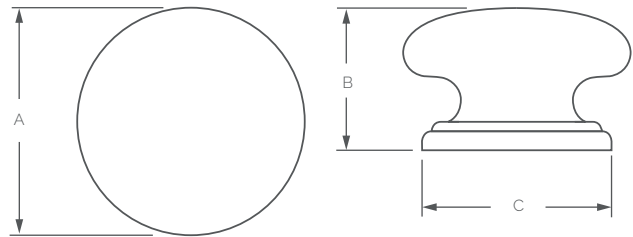

PRODUCT NUMBER	A	B	C
1032 Knob	1/2"	7/16"	3/8"
1066 Knob	3/4"	3/4"	7/16"
1067 Knob	1"	1"	9/16"
1134 Knob	1-1/4"	1-1/8"	3/4"
1233 Knob	1-1/2"	1-1/8"	3/4"

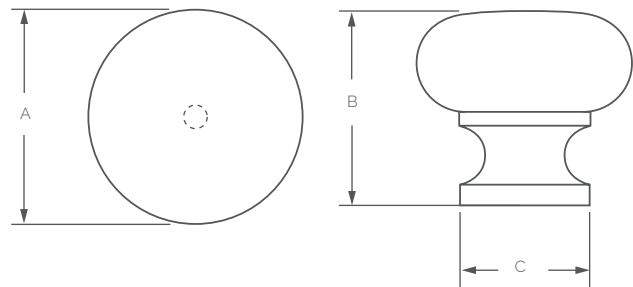

CABINET PULLS

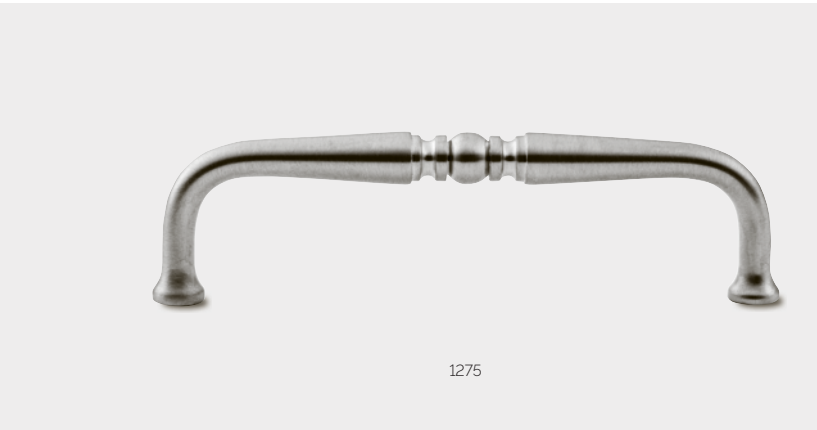

1275

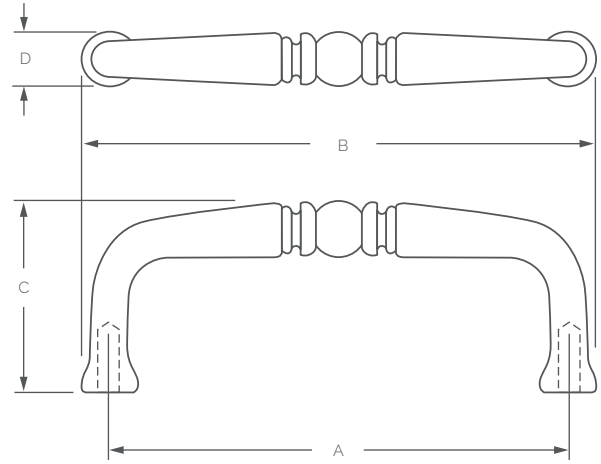

PRODUCT NUMBER	A	B	C	D
1002 Pull	3"	3-3/8"	1-7/32"	3/8"
1262 Pull	3-1/2"	3-7/8"	1-3/16"	3/8"
1275 Pull	4"	4-3/8"	1-1/4"	3/8"



1237

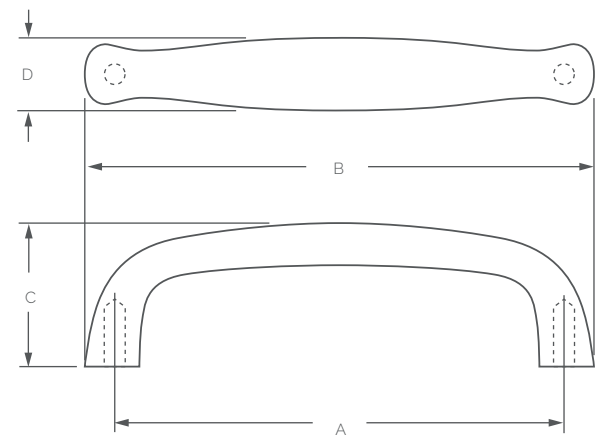

PRODUCT NUMBER	A	B	C	D
1236 Pull	3"	3-3/8"	15/16"	19/32"
1237 Pull	4"	4-1/2"	1-1/8"	9/16"

CABINET PULLS

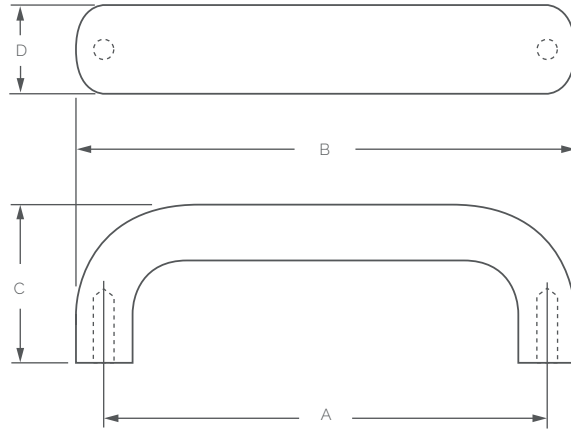

PRODUCT NUMBER	A	B	C	D
1235 Pull	3"	3-3/8"	1-1/8"	19/32"

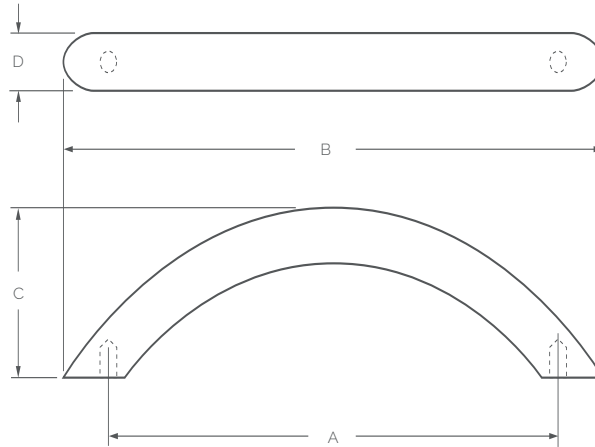

PRODUCT NUMBER	A	B	C	D
1239 Pull	96mm	4-1/2"	1-3/32"	3/8"
1298 Pull	128mm	6"	1-1/4"	3/8"
1299 Pull	224mm	10-5/16"	1-3/8"	7/16"

CABINET PULLS



1859

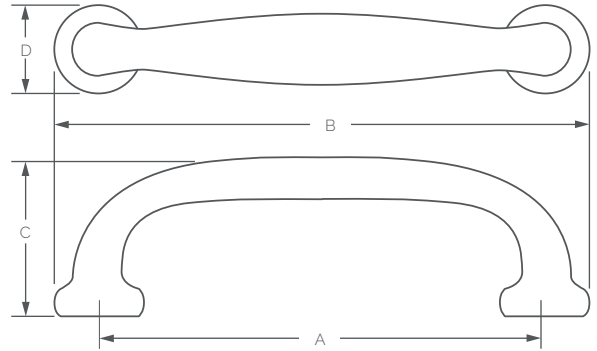

PRODUCT NUMBER	A	B	C	D
1857 Pull	4-1/2"	5-3/8"	1-3/4"	7/8"
1858 Pull	5"	6-1/16"	1-13/16"	1"
1859 Pull	8"	9-1/16"	1-13/16"	13/16"
1860 Appliance Pull	12"	13-3/16"	2"	1-1/8"
1861 Appliance Pull	18"	19-3/16"	2"	1-1/4"

REMEMBER

Appliance pulls are available as B-T-B and single sided applications.



1876

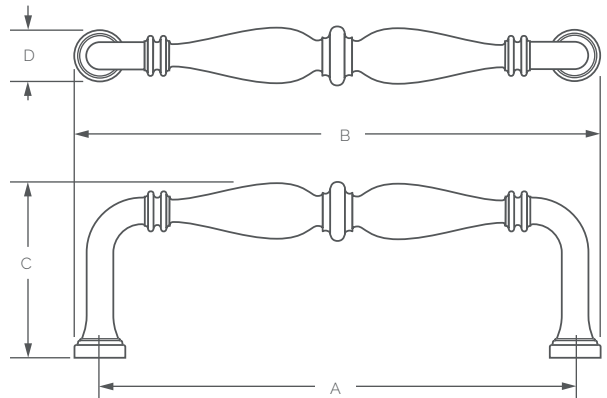

PRODUCT NUMBER	A	B	C	D
1874 Pull	4"	4-7/16"	1-1/2"	7/16"
1876 Pull	6"	6-7/16"	1-1/2"	7/16"
1877 Pull	8"	8-7/16"	1-1/2"	7/16"
1878 Appliance Pull	8"	8-7/8"	2-5/16"	7/8"
1882 Appliance Pull	12"	12-7/8"	2-7/8"	7/8"
1888 Appliance Pull	18"	19"	2-13/16"	1"

REMEMBER

Appliance pulls are available as B-T-B and single sided applications.

CUP PULLS



1264

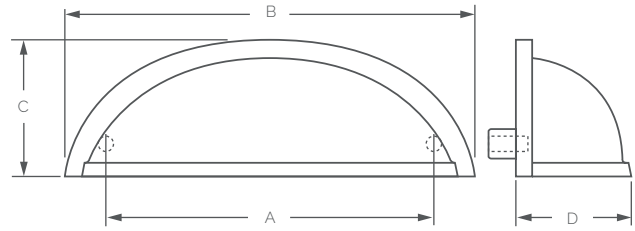

PRODUCT NUMBER	A	B	C	D
1264 Cup Pull	3"	3-3/4"	1-1/4"	1"



1263

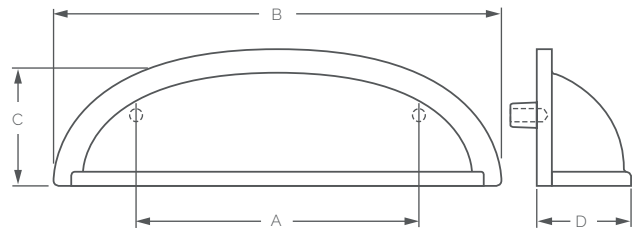

PRODUCT NUMBER	A	B	C	D
1263 Cup Pull	3"	4-5/8"	1-3/8"	1"

CUP PULLS



1266

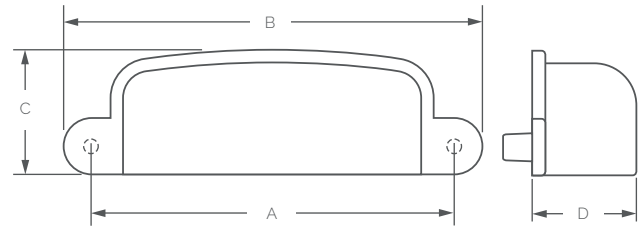

PRODUCT NUMBER	A	B	C	D
1266 Cup Pull	3-1/2"	4"	1-3/16"	1"



1267

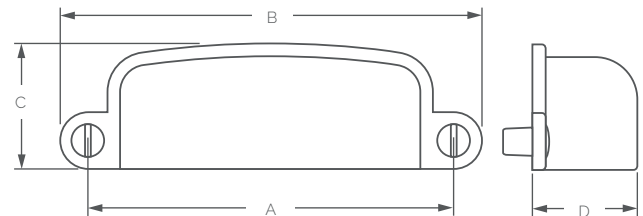

PRODUCT NUMBER	A	B	C	D
1267 Cup Pull w/ Exposed Screws	3-1/2"	4"	1-3/16"	1"

CUP PULLS



1268

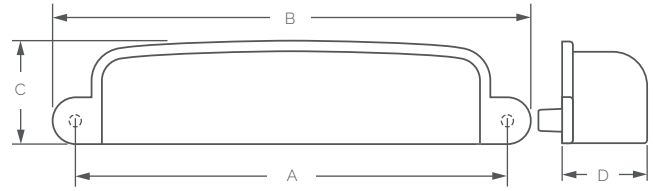

PRODUCT NUMBER	A	B	C	D
1268 Cup Pull	5"	5-1/2"	1-3/16"	1"



1269

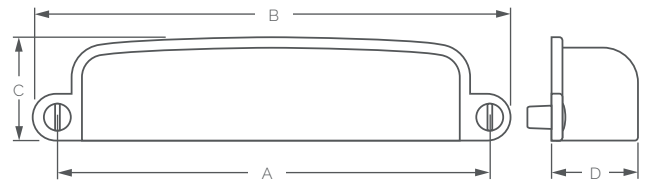

PRODUCT NUMBER	A	B	C	D
1269 Cup Pull w/ Exposed Screws	5"	5-1/2"	1-3/16"	1"

BACKPLATES



1142

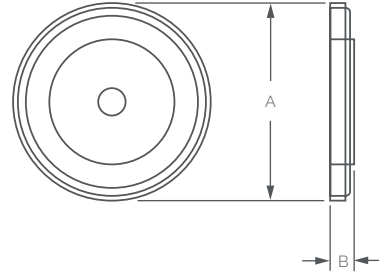

PRODUCT NUMBER	A	B
1142 Backplate	1-1/4"	3/16"



1148

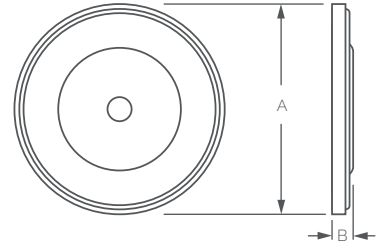

PRODUCT NUMBER	A	B
1148 Backplate	1-1/2"	5/32"



1847

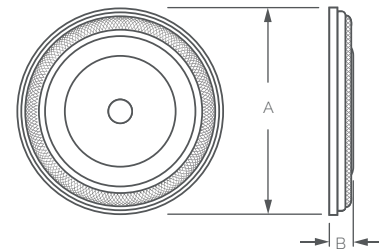

PRODUCT NUMBER	A	B
1847 Backplate - Cross Hatch	1-5/8"	3/16"

BACKPLATES



1848

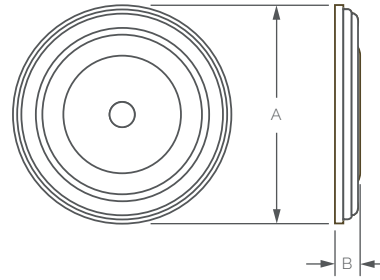

PRODUCT NUMBER	A	B
1848 Backplate	1-5/8"	3/16"



1849

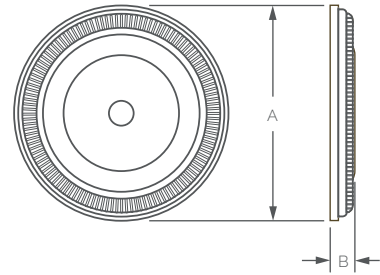

PRODUCT NUMBER	A	B
1849 Backplate - Coin	1-5/8"	3/16"

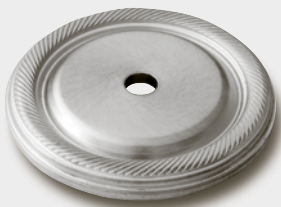

1840

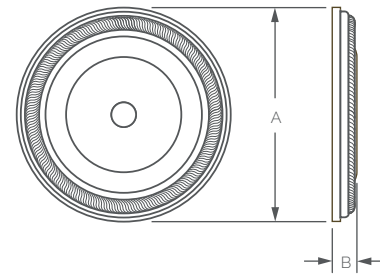

PRODUCT NUMBER	A	B
1840 Backplate - Rope	1-5/8"	3/16"

BACKPLATES



1197

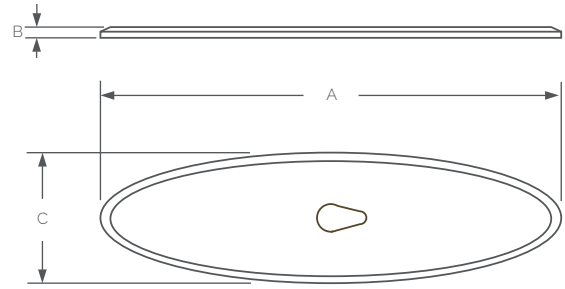

PRODUCT NUMBER	A	B	C
1197 Oval Backplate	3"	1/16"	7/8"



1261

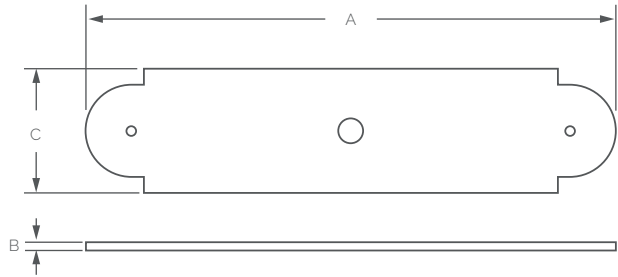

PRODUCT NUMBER	A	B	C
1261 Backplate	4"	1/16"	15/16"

BAIL PULLS



6001



6003

PRODUCT NUMBER	A	B	C
6001 Bail Pull	3-1/2"	4-3/4"	2-1/8"
6003 Bail Pull	4"	5-1/4"	2-1/2"

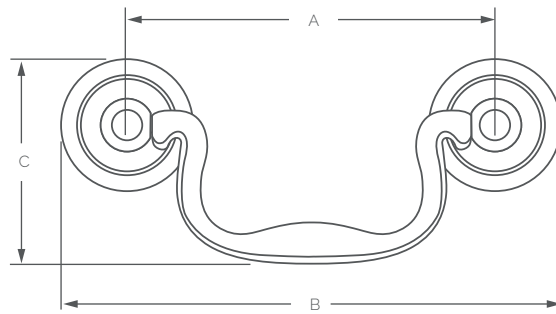

6006



6027

PRODUCT NUMBER	A	B	C
6006 Bail Pull	3"	4-1/4"	2-1/4"
6027 Bail Pull	3"	4"	2-1/8"

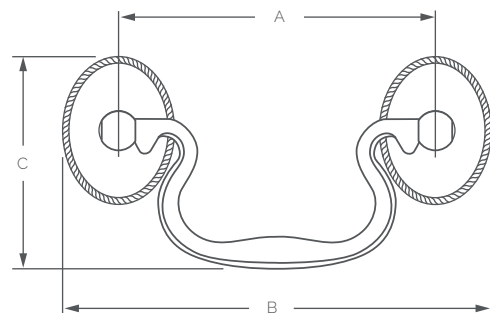

BAIL PULLS



6035

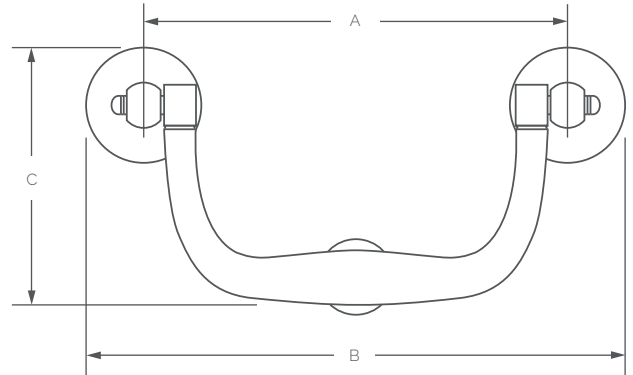

PRODUCT NUMBER	A	B	C
6035 Bail Pull	3-1/2"	4-15/32"	2-3/16"



6050

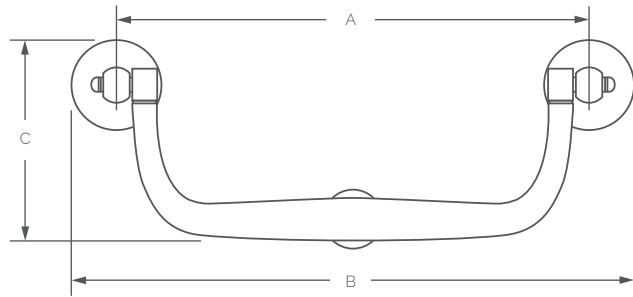

PRODUCT NUMBER	A	B	C
6050 Bail Pull	5"	5-31/32"	2-3/16"



EDGE PULLS

EDGE PULLS



3546

PRODUCT NUMBER	A	B	C	D	E
3542 Edge Pull - Round	2"	1-1/2"	5/16"	5/16"	1/8"
3544 Edge Pull - Round	4"	1-1/2"	5/16"	5/16"	1/8"
3546 Edge Pull - Round	6"	1-1/2"	5/16"	5/16"	1/8"
3548 Edge Pull - Round	8"	1-1/2"	5/16"	5/16"	1/8"
3550 Edge Pull - Round	10"	1-1/2"	5/16"	5/16"	1/8"
3552 Edge Pull - Round	12"	1-1/2"	5/16"	5/16"	1/8"
3558 Edge Pull - Round	18"	1-1/2"	5/16"	5/16"	1/8"
3560 Edge Pull - Round	24"	1-1/2"	5/16"	5/16"	1/8"
3561 Edge Pull - Round	30"	1-1/2"	5/16"	5/16"	1/8"
3562 Edge Pull - Round	36"	1-1/2"	5/16"	5/16"	1/8"
3564 Edge Pull - Round	48"	1-1/2"	5/16"	5/16"	1/8"

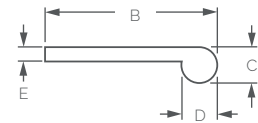
**REMEMBER**

Custom lengths available.

EDGE PULLS



3576

PRODUCT NUMBER	A	B	C	D	E
3572 Edge Pull - Square	2"	1-1/2"	3/8"	1/4"	1/8"
3574 Edge Pull - Square	4"	1-1/2"	3/8"	1/4"	1/8"
3576 Edge Pull - Square	6"	1-1/2"	3/8"	1/4"	1/8"
3578 Edge Pull - Square	8"	1-1/2"	3/8"	1/4"	1/8"
3580 Edge Pull - Square	10"	1-1/2"	3/8"	1/4"	1/8"
3582 Edge Pull - Square	12"	1-1/2"	3/8"	1/4"	1/8"
3588 Edge Pull - Square	18"	1-1/2"	3/8"	1/4"	1/8"
3590 Edge Pull - Square	24"	1-1/2"	3/8"	1/4"	1/8"
3591 Edge Pull - Square	30"	1-1/2"	3/8"	1/4"	1/8"
3592 Edge Pull - Square	36"	1-1/2"	3/8"	1/4"	1/8"
3594 Edge Pull - Square	48"	1-1/2"	3/8"	1/4"	1/8"

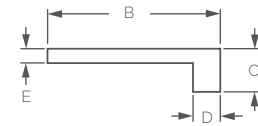
**REMEMBER**

Custom lengths available.

EDGE PULLS



3666

PRODUCT NUMBER	A	B	C	D	E
3662 Edge Pull - Angle	2"	1-1/2"	5/8"	1/8"	1/8"
3664 Edge Pull - Angle	4"	1-1/2"	5/8"	1/8"	1/8"
3666 Edge Pull - Angle	6"	1-1/2"	5/8"	1/8"	1/8"
3668 Edge Pull - Angle	8"	1-1/2"	5/8"	1/8"	1/8"
3670 Edge Pull - Angle	10"	1-1/2"	5/8"	1/8"	1/8"
3672 Edge Pull - Angle	12"	1-1/2"	5/8"	1/8"	1/8"
3678 Edge Pull - Angle	18"	1-1/2"	5/8"	1/8"	1/8"
3680 Edge Pull - Angle	24"	1-1/2"	5/8"	1/8"	1/8"
3681 Edge Pull - Angle	30"	1-1/2"	5/8"	1/8"	1/8"
3682 Edge Pull - Angle	36"	1-1/2"	5/8"	1/8"	1/8"
3684 Edge Pull - Angle	48"	1-1/2"	5/8"	1/8"	1/8"

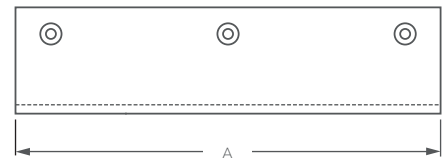
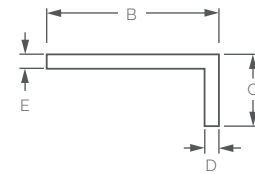

REMEMBER

Custom lengths available.

EDGE PULLS



3776

PRODUCT NUMBER	A	B	C	D	E
3772 Edge Pull - Curve	2"	1-11/16"	5/8"	1/4"	1/8"
3774 Edge Pull - Curve	4"	1-11/16"	5/8"	1/4"	1/8"
3776 Edge Pull - Curve	6"	1-11/16"	5/8"	1/4"	1/8"
3778 Edge Pull - Curve	8"	1-11/16"	5/8"	1/4"	1/8"
3780 Edge Pull - Curve	10"	1-11/16"	5/8"	1/4"	1/8"
3782 Edge Pull - Curve	12"	1-11/16"	5/8"	1/4"	1/8"
3788 Edge Pull - Curve	18"	1-11/16"	5/8"	1/4"	1/8"
3790 Edge Pull - Curve	24"	1-11/16"	5/8"	1/4"	1/8"
3791 Edge Pull - Curve	30"	1-11/16"	5/8"	1/4"	1/8"
3792 Edge Pull - Curve	36"	1-11/16"	5/8"	1/4"	1/8"
3794 Edge Pull - Curve	48"	1-11/16"	5/8"	1/4"	1/8"

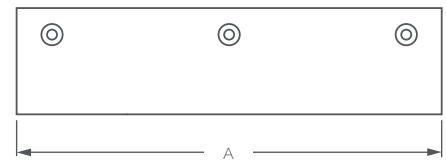
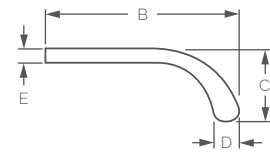

REMEMBER

Custom lengths available.

EDGE PULLS



11706

PRODUCT NUMBER	A	B	C	D	E
11702 Edge Pull - Bullnose	2"	1-9/16"	3/8"	5/16"	1/8"
11704 Edge Pull - Bullnose	4"	1-9/16"	3/8"	5/16"	1/8"
11706 Edge Pull - Bullnose	6"	1-9/16"	3/8"	5/16"	1/8"
11708 Edge Pull - Bullnose	8"	1-9/16"	3/8"	5/16"	1/8"
11710 Edge Pull - Bullnose	10"	1-9/16"	3/8"	5/16"	1/8"
11712 Edge Pull - Bullnose	12"	1-9/16"	3/8"	5/16"	1/8"
11718 Edge Pull - Bullnose	18"	1-9/16"	3/8"	5/16"	1/8"
11720 Edge Pull - Bullnose	24"	1-9/16"	3/8"	5/16"	1/8"
11721 Edge Pull - Bullnose	30"	1-9/16"	3/8"	5/16"	1/8"
11722 Edge Pull - Bullnose	36"	1-9/16"	3/8"	5/16"	1/8"
11724 Edge Pull - Bullnose	48"	1-9/16"	3/8"	5/16"	1/8"

REMEMBER

Custom lengths available.

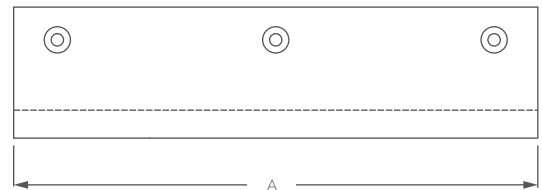
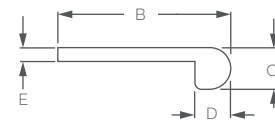

EDGE PULLS



11736

PRODUCT NUMBER	A	B	C	D	E
11732 Edge Pull - Bullnose w/ Radius	2"	1-9/16"	3/8"	5/16"	1/8"
11734 Edge Pull - Bullnose w/ Radius	4"	1-9/16"	3/8"	5/16"	1/8"
11736 Edge Pull - Bullnose w/ Radius	6"	1-9/16"	3/8"	5/16"	1/8"
11738 Edge Pull - Bullnose w/ Radius	8"	1-9/16"	3/8"	5/16"	1/8"
11740 Edge Pull - Bullnose w/ Radius	10"	1-9/16"	3/8"	5/16"	1/8"
11742 Edge Pull - Bullnose w/ Radius	12"	1-9/16"	3/8"	5/16"	1/8"
11748 Edge Pull - Bullnose w/ Radius	18"	1-9/16"	3/8"	5/16"	1/8"
11750 Edge Pull - Bullnose w/ Radius	24"	1-9/16"	3/8"	5/16"	1/8"
11751 Edge Pull - Bullnose w/ Radius	30"	1-9/16"	3/8"	5/16"	1/8"
11752 Edge Pull - Bullnose w/ Radius	36"	1-9/16"	3/8"	5/16"	1/8"
11753 Edge Pull - Bullnose w/ Radius	48"	1-9/16"	3/8"	5/16"	1/8"

REMEMBER

Custom lengths available.

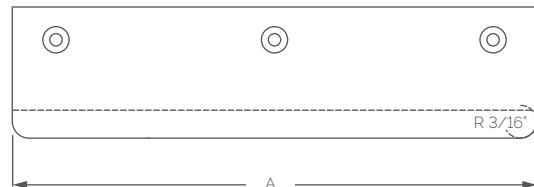
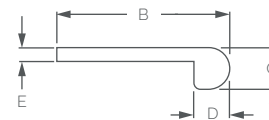

EDGE PULLS



11766

PRODUCT NUMBER	A	B	C	D	E
11762 Edge Pull - Diamond	2"	1-9/16"	3/8"	5/16"	1/8"
11764 Edge Pull - Diamond	4"	1-9/16"	3/8"	5/16"	1/8"
11766 Edge Pull - Diamond	6"	1-9/16"	3/8"	5/16"	1/8"
11768 Edge Pull - Diamond	8"	1-9/16"	3/8"	5/16"	1/8"
11770 Edge Pull - Diamond	10"	1-9/16"	3/8"	5/16"	1/8"
11772 Edge Pull - Diamond	12"	1-9/16"	3/8"	5/16"	1/8"
11778 Edge Pull - Diamond	18"	1-9/16"	3/8"	5/16"	1/8"
11780 Edge Pull - Diamond	24"	1-9/16"	3/8"	5/16"	1/8"
11781 Edge Pull - Diamond	30"	1-9/16"	3/8"	5/16"	1/8"
11782 Edge Pull - Diamond	36"	1-9/16"	3/8"	5/16"	1/8"
11784 Edge Pull - Diamond	48"	1-9/16"	3/8"	5/16"	1/8"

REMEMBER

Custom lengths available.

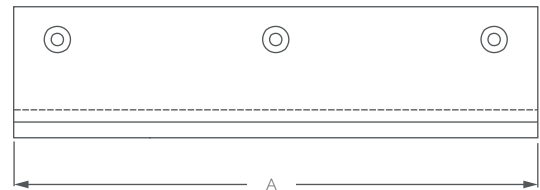
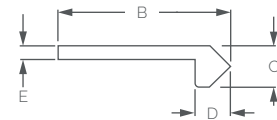

EDGE PULLS



11806

PRODUCT NUMBER	A	B	C	D	E
11802 Edge Pull - Diamond w/ Facets	2"	1-9/16"	3/8"	5/16"	1/8"
11804 Edge Pull - Diamond w/ Facets	4"	1-9/16"	3/8"	5/16"	1/8"
11806 Edge Pull - Diamond w/ Facets	6"	1-9/16"	3/8"	5/16"	1/8"
11808 Edge Pull - Diamond w/ Facets	8"	1-9/16"	3/8"	5/16"	1/8"
11810 Edge Pull - Diamond w/ Facets	10"	1-9/16"	3/8"	5/16"	1/8"
11812 Edge Pull - Diamond w/ Facets	12"	1-9/16"	3/8"	5/16"	1/8"
11818 Edge Pull - Diamond w/ Facets	18"	1-9/16"	3/8"	5/16"	1/8"
11820 Edge Pull - Diamond w/ Facets	24"	1-9/16"	3/8"	5/16"	1/8"
11821 Edge Pull - Diamond w/ Facets	30"	1-9/16"	3/8"	5/16"	1/8"
11822 Edge Pull - Diamond w/ Facets	36"	1-9/16"	3/8"	5/16"	1/8"
11824 Edge Pull - Diamond w/ Facets	48"	1-9/16"	3/8"	5/16"	1/8"

REMEMBER

Custom lengths available.

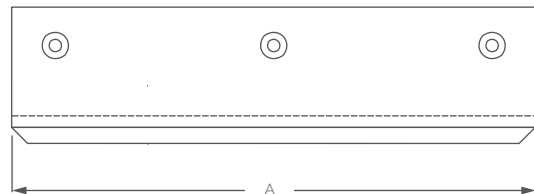
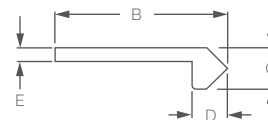

EDGE PULLS



11836

PRODUCT NUMBER	A	B	C	D	E	F
11832 Edge Pull - Round w/ Backmount	2"	1-5/8"	5/16"	5/16"	3/4"	1/8"
11834 Edge Pull - Round w/ Backmount	4"	1-5/8"	5/16"	5/16"	3/4"	1/8"
11836 Edge Pull - Round w/ Backmount	6"	1-5/8"	5/16"	5/16"	3/4"	1/8"
11838 Edge Pull - Round w/ Backmount	8"	1-5/8"	5/16"	5/16"	3/4"	1/8"
11840 Edge Pull - Round w/ Backmount	10"	1-5/8"	5/16"	5/16"	3/4"	1/8"
11842 Edge Pull - Round w/ Backmount	12"	1-5/8"	5/16"	5/16"	3/4"	1/8"
11848 Edge Pull - Round w/ Backmount	18"	1-5/8"	5/16"	5/16"	3/4"	1/8"
11850 Edge Pull - Round w/ Backmount	24"	1-5/8"	5/16"	5/16"	3/4"	1/8"
11851 Edge Pull - Round w/ Backmount	30"	1-5/8"	5/16"	5/16"	3/4"	1/8"
11852 Edge Pull - Round w/ Backmount	36"	1-5/8"	5/16"	5/16"	3/4"	1/8"
11854 Edge Pull - Round w/ Backmount	48"	1-5/8"	5/16"	5/16"	3/4"	1/8"

REMEMBER

Custom lengths available.

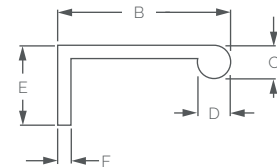

EDGE PULLS



11866

PRODUCT NUMBER	A	B	C	D	E	F
11862 Edge Pull - Angle w/ Backmount	2"	1-5/8"	5/8"	1/8"	3/4"	1/8"
11864 Edge Pull - Angle w/ Backmount	4"	1-5/8"	5/8"	1/8"	3/4"	1/8"
11866 Edge Pull - Angle w/ Backmount	6"	1-5/8"	5/8"	1/8"	3/4"	1/8"
11868 Edge Pull - Angle w/ Backmount	8"	1-5/8"	5/8"	1/8"	3/4"	1/8"
11870 Edge Pull - Angle w/ Backmount	10"	1-5/8"	5/8"	1/8"	3/4"	1/8"
11872 Edge Pull - Angle w/ Backmount	12"	1-5/8"	5/8"	1/8"	3/4"	1/8"
11878 Edge Pull - Angle w/ Backmount	18"	1-5/8"	5/8"	1/8"	3/4"	1/8"
11880 Edge Pull - Angle w/ Backmount	24"	1-5/8"	5/8"	1/8"	3/4"	1/8"
11881 Edge Pull - Angle w/ Backmount	30"	1-5/8"	5/8"	1/8"	3/4"	1/8"
11882 Edge Pull - Angle w/ Backmount	36"	1-5/8"	5/8"	1/8"	3/4"	1/8"
11884 Edge Pull - Angle w/ Backmount	48"	1-5/8"	5/8"	1/8"	3/4"	1/8"

REMEMBER

Custom lengths available.

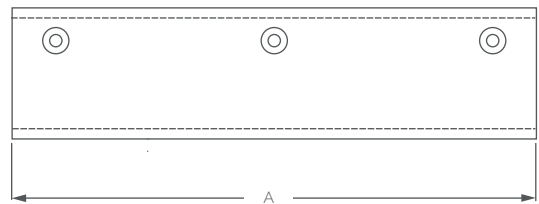
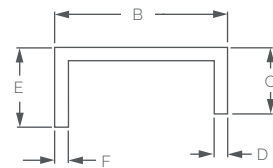

EDGE PULLS



11906

PRODUCT NUMBER	A	B	C	D	E	F
11902 Edge Pull - Square w/ Backmount	2"	1-5/8"	3/8"	1/4"	3/4"	1/8"
11904 Edge Pull - Square w/ Backmount	4"	1-5/8"	3/8"	1/4"	3/4"	1/8"
11906 Edge Pull - Square w/ Backmount	6"	1-5/8"	3/8"	1/4"	3/4"	1/8"
11908 Edge Pull - Square w/ Backmount	8"	1-5/8"	3/8"	1/4"	3/4"	1/8"
11910 Edge Pull - Square w/ Backmount	10"	1-5/8"	3/8"	1/4"	3/4"	1/8"
11912 Edge Pull - Square w/ Backmount	12"	1-5/8"	3/8"	1/4"	3/4"	1/8"
11918 Edge Pull - Square w/ Backmount	18"	1-5/8"	3/8"	1/4"	3/4"	1/8"
11924 Edge Pull - Square w/ Backmount	24"	1-5/8"	3/8"	1/4"	3/4"	1/8"
11930 Edge Pull - Square w/ Backmount	30"	1-5/8"	3/8"	1/4"	3/4"	1/8"
11936 Edge Pull - Square w/ Backmount	36"	1-5/8"	3/8"	1/4"	3/4"	1/8"
11948 Edge Pull - Square w/ Backmount	48"	1-5/8"	3/8"	1/4"	3/4"	1/8"

REMEMBER

Custom lengths available.

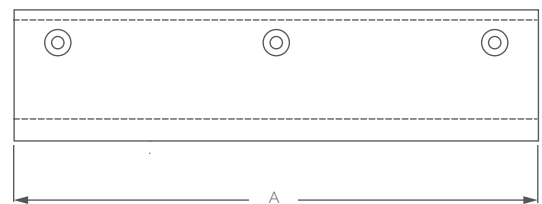
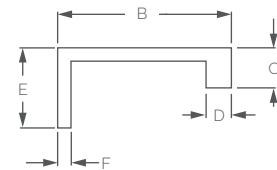

EDGE PULLS

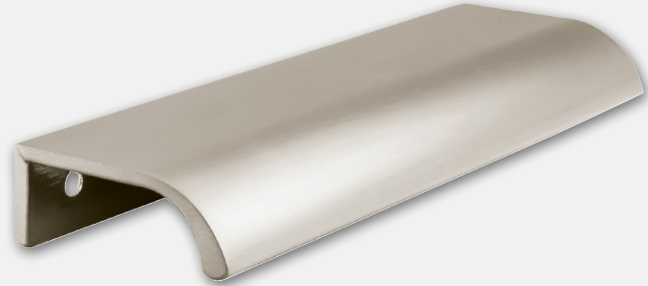

11956

PRODUCT NUMBER	A	B	C	D	E	F
11952 Edge Pull - Curve w/ Backmount	2"	1-13/16"	5/8"	1/8"	3/4"	1/8"
11954 Edge Pull - Curve w/ Backmount	4"	1-13/16"	5/8"	1/8"	3/4"	1/8"
11956 Edge Pull - Curve w/ Backmount	6"	1-13/16"	5/8"	1/8"	3/4"	1/8"
11958 Edge Pull - Curve w/ Backmount	8"	1-13/16"	5/8"	1/8"	3/4"	1/8"
11960 Edge Pull - Curve w/ Backmount	10"	1-13/16"	5/8"	1/8"	3/4"	1/8"
11962 Edge Pull - Curve w/ Backmount	12"	1-13/16"	5/8"	1/8"	3/4"	1/8"
11968 Edge Pull - Curve w/ Backmount	18"	1-13/16"	5/8"	1/8"	3/4"	1/8"
11974 Edge Pull - Curve w/ Backmount	24"	1-13/16"	5/8"	1/8"	3/4"	1/8"
11980 Edge Pull - Curve w/ Backmount	30"	1-13/16"	5/8"	1/8"	3/4"	1/8"
11984 Edge Pull - Curve w/ Backmount	36"	1-13/16"	5/8"	1/8"	3/4"	1/8"
11988 Edge Pull - Curve w/ Backmount	48"	1-13/16"	5/8"	1/8"	3/4"	1/8"

REMEMBER

Custom lengths available.

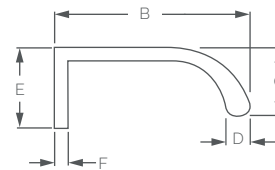

EDGE PULLS

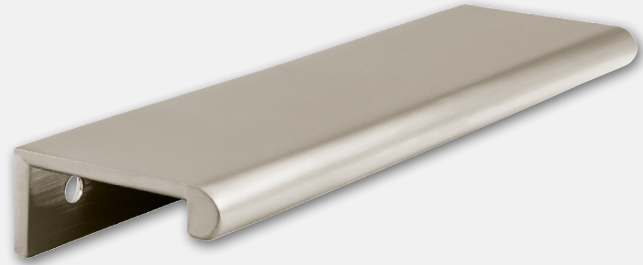

12006

PRODUCT NUMBER	A	B	C	D	E	F
12002 Edge Pull - Bullnose w/ Backmount	2"	1-11/16"	3/8"	5/16"	3/4"	1/8"
12004 Edge Pull - Bullnose w/ Backmount	4"	1-11/16"	3/8"	5/16"	3/4"	1/8"
12006 Edge Pull - Bullnose w/ Backmount	6"	1-11/16"	3/8"	5/16"	3/4"	1/8"
12008 Edge Pull - Bullnose w/ Backmount	8"	1-11/16"	3/8"	5/16"	3/4"	1/8"
12010 Edge Pull - Bullnose w/ Backmount	10"	1-11/16"	3/8"	5/16"	3/4"	1/8"
12012 Edge Pull - Bullnose w/ Backmount	12"	1-11/16"	3/8"	5/16"	3/4"	1/8"
12018 Edge Pull - Bullnose w/ Backmount	18"	1-11/16"	3/8"	5/16"	3/4"	1/8"
12024 Edge Pull - Bullnose w/ Backmount	24"	1-11/16"	3/8"	5/16"	3/4"	1/8"
12030 Edge Pull - Bullnose w/ Backmount	30"	1-11/16"	3/8"	5/16"	3/4"	1/8"
12036 Edge Pull - Bullnose w/ Backmount	36"	1-11/16"	3/8"	5/16"	3/4"	1/8"
12048 Edge Pull - Bullnose w/ Backmount	48"	1-11/16"	3/8"	5/16"	3/4"	1/8"

REMEMBER

Custom lengths available.

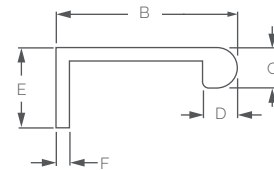

EDGE PULLS

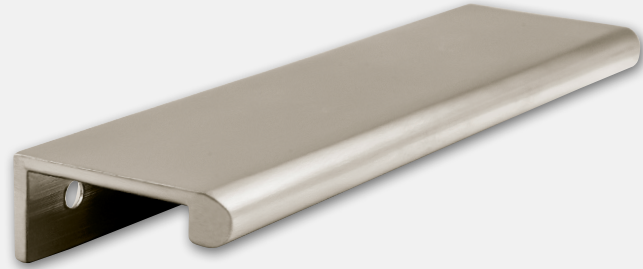

12056

PRODUCT NUMBER	A	B	C	D	E	F
12052 Edge Pull - Bullnose w/ Radius & Backmount	2"	1-11/16"	3/8"	5/16"	3/4"	1/8"
12054 Edge Pull - Bullnose w/ Radius & Backmount	4"	1-11/16"	3/8"	5/16"	3/4"	1/8"
12056 Edge Pull - Bullnose w/ Radius & Backmount	6"	1-11/16"	3/8"	5/16"	3/4"	1/8"
12058 Edge Pull - Bullnose w/ Radius & Backmount	8"	1-11/16"	3/8"	5/16"	3/4"	1/8"
12060 Edge Pull - Bullnose w/ Radius & Backmount	10"	1-11/16"	3/8"	5/16"	3/4"	1/8"
12062 Edge Pull - Bullnose w/ Radius & Backmount	12"	1-11/16"	3/8"	5/16"	3/4"	1/8"
12068 Edge Pull - Bullnose w/ Radius & Backmount	18"	1-11/16"	3/8"	5/16"	3/4"	1/8"
12074 Edge Pull - Bullnose w/ Radius & Backmount	24"	1-11/16"	3/8"	5/16"	3/4"	1/8"
12080 Edge Pull - Bullnose w/ Radius & Backmount	30"	1-11/16"	3/8"	5/16"	3/4"	1/8"
12086 Edge Pull - Bullnose w/ Radius & Backmount	36"	1-11/16"	3/8"	5/16"	3/4"	1/8"
12088 Edge Pull - Bullnose w/ Radius & Backmount	48"	1-11/16"	3/8"	5/16"	3/4"	1/8"

REMEMBER

Custom lengths available.

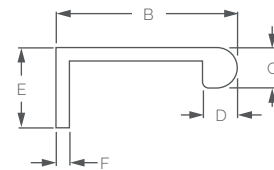

EDGE PULLS

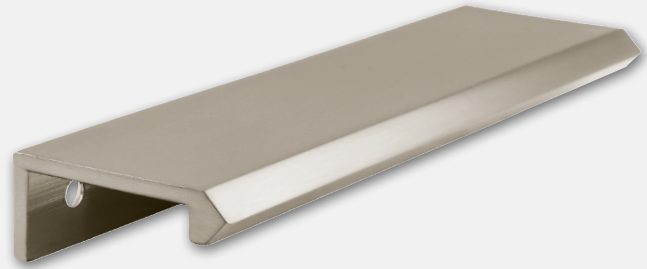

12106

PRODUCT NUMBER	A	B	C	D	E	F
12102 Edge Pull - Diamond w/ Backmount	2"	1-11/16"	3/8"	5/16"	3/4"	1/8"
12104 Edge Pull - Diamond w/ Backmount	4"	1-11/16"	3/8"	5/16"	3/4"	1/8"
12106 Edge Pull - Diamond w/ Backmount	6"	1-11/16"	3/8"	5/16"	3/4"	1/8"
12108 Edge Pull - Diamond w/ Backmount	8"	1-11/16"	3/8"	5/16"	3/4"	1/8"
12110 Edge Pull - Diamond w/ Backmount	10"	1-11/16"	3/8"	5/16"	3/4"	1/8"
12112 Edge Pull - Diamond w/ Backmount	12"	1-11/16"	3/8"	5/16"	3/4"	1/8"
12118 Edge Pull - Diamond w/ Backmount	18"	1-11/16"	3/8"	5/16"	3/4"	1/8"
12124 Edge Pull - Diamond w/ Backmount	24"	1-11/16"	3/8"	5/16"	3/4"	1/8"
12130 Edge Pull - Diamond w/ Backmount	30"	1-11/16"	3/8"	5/16"	3/4"	1/8"
12136 Edge Pull - Diamond w/ Backmount	36"	1-11/16"	3/8"	5/16"	3/4"	1/8"
12138 Edge Pull - Diamond w/ Backmount	48"	1-11/16"	3/8"	5/16"	3/4"	1/8"

REMEMBER

Custom lengths available.

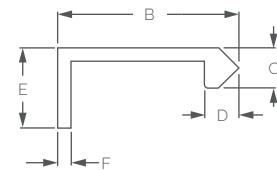

EDGE PULLS



12156

PRODUCT NUMBER	A	B	C	D	E	F
12152 Edge Pull - Diamond w/ Facets & Backmount	2"	1-11/16"	3/8"	5/16"	3/4"	1/8"
12154 Edge Pull - Diamond w/ Facets & Backmount	4"	1-11/16"	3/8"	5/16"	3/4"	1/8"
12156 Edge Pull - Diamond w/ Facets & Backmount	6"	1-11/16"	3/8"	5/16"	3/4"	1/8"
12158 Edge Pull - Diamond w/ Facets & Backmount	8"	1-11/16"	3/8"	5/16"	3/4"	1/8"
12160 Edge Pull - Diamond w/ Facets & Backmount	10"	1-11/16"	3/8"	5/16"	3/4"	1/8"
12162 Edge Pull - Diamond w/ Facets & Backmount	12"	1-11/16"	3/8"	5/16"	3/4"	1/8"
12168 Edge Pull - Diamond w/ Facets & Backmount	18"	1-11/16"	3/8"	5/16"	3/4"	1/8"
12174 Edge Pull - Diamond w/ Facets & Backmount	24"	1-11/16"	3/8"	5/16"	3/4"	1/8"
12180 Edge Pull - Diamond w/ Facets & Backmount	30"	1-11/16"	3/8"	5/16"	3/4"	1/8"
12186 Edge Pull - Diamond w/ Facets & Backmount	36"	1-11/16"	3/8"	5/16"	3/4"	1/8"
12188 Edge Pull - Diamond w/ Facets & Backmount	48"	1-11/16"	3/8"	5/16"	3/4"	1/8"

REMEMBER

Custom lengths available.

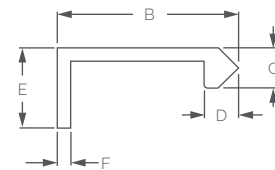



CABINET KNOBS



3901



3903



3902

PRODUCT NUMBER	A	B	C
3901 Knob	1-1/4"	1-3/16"	11/16"
3902 Knob	1-1/2"	1-7/16"	25/32"
3903 Knob	1-3/8"	1-5/16"	3/4"

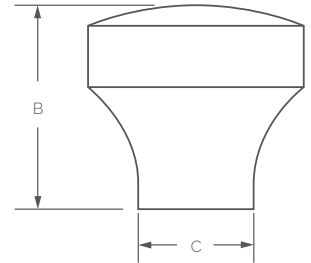
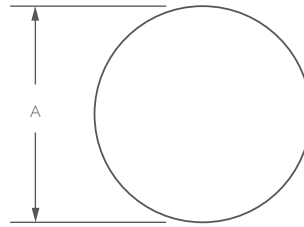

3941



3942



3943

PRODUCT NUMBER	A	B	C
3941 Knob - Coin	1-1/4"	1-3/16"	11/16"
3942 Knob - Coin	1-3/8"	1-5/16"	3/4"
3943 Knob - Coin	1-1/2"	1-7/16"	25/32"

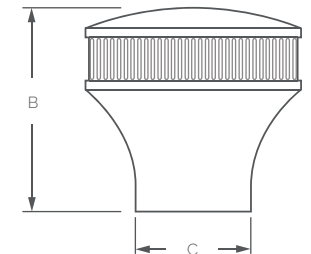
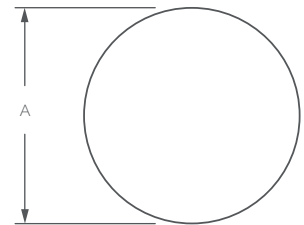

CABINET KNOBS



3946



3947



3948

PRODUCT NUMBER	A	B	C
3946 Knob - Cross Hatch	1-1/4"	1-3/16"	11/16"
3947 Knob - Cross Hatch	1-3/8"	1-5/16"	3/4"
3948 Knob - Cross Hatch	1-1/2"	1-7/16"	25/32"

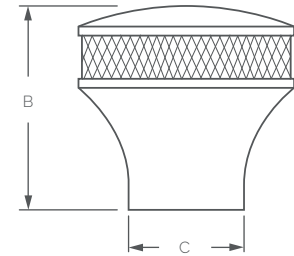
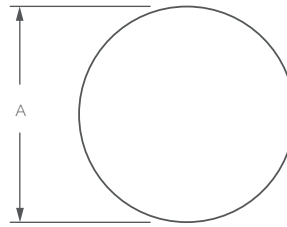

3914



3916

PRODUCT NUMBER	A	B	C
3914 Knob	1-1/4"	1-1/8"	1/2"
3916 Knob	1-1/2"	1-3/8"	9/16"

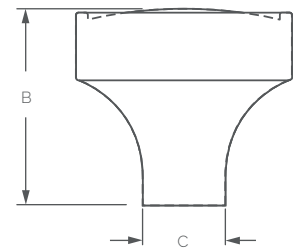
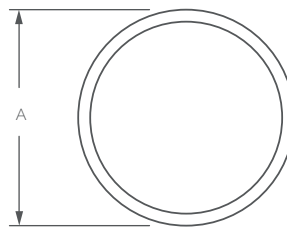

CABINET KNOBS & PULLS

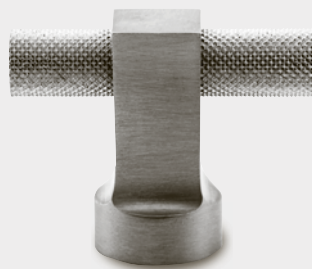

3950

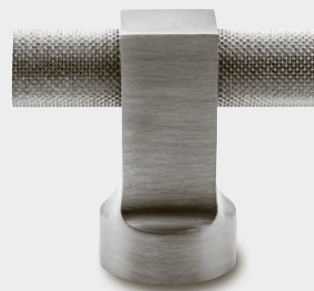

3952

PRODUCT NUMBER	A	B	C	D
3950 T Knob - Diamond	1-3/4"	1-3/8"	3/4"	3/8"
3952 T Knob - Diamond	2"	1-21/32"	15/16"	1/2"

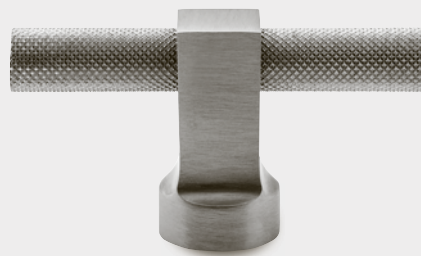
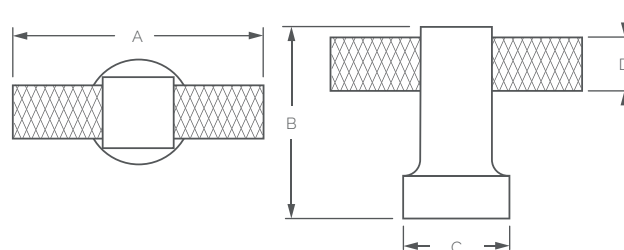

3953

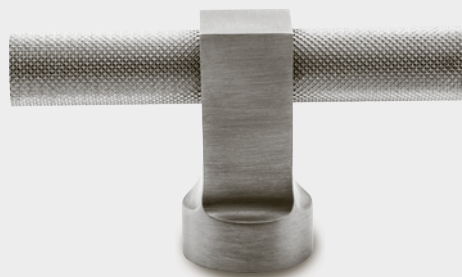

3955

PRODUCT NUMBER	A	B	C	D
3953 T Pull - Diamond	2-1/2"	1-3/8"	3/4"	3/8"
3955 T Pull - Diamond	3-1/8"	1-11/16"	15/16"	1/2"

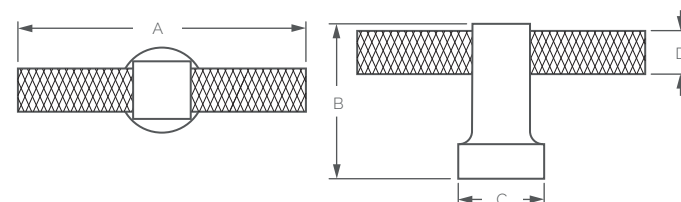

CABINET PULLS

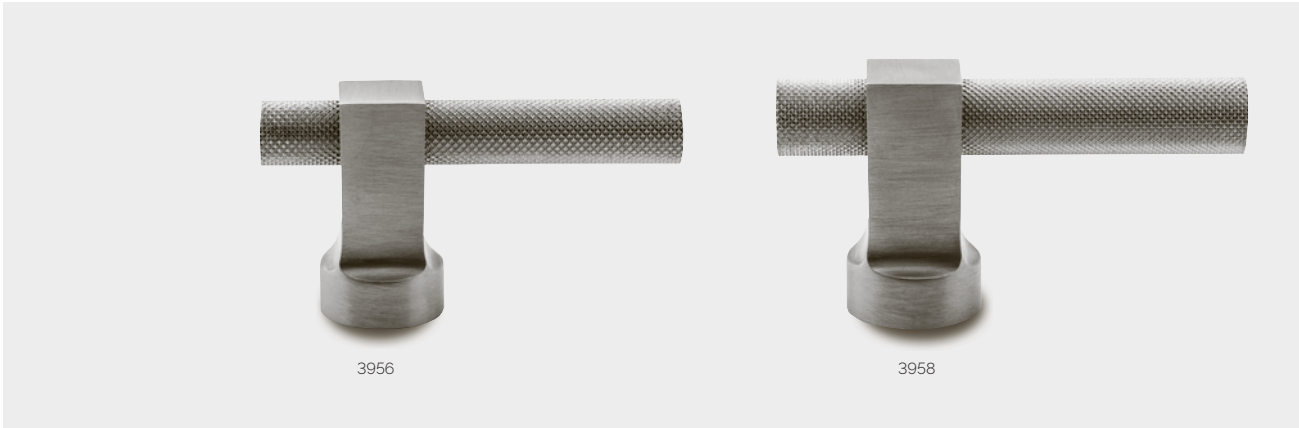

PRODUCT NUMBER	A	B	C	D
3956 L Pull - Diamond	2-1/2"	1-3/8"	3/4"	3/8"
3958 L Pull - Diamond	3-1/8"	1-11/16"	15/16"	1/2"

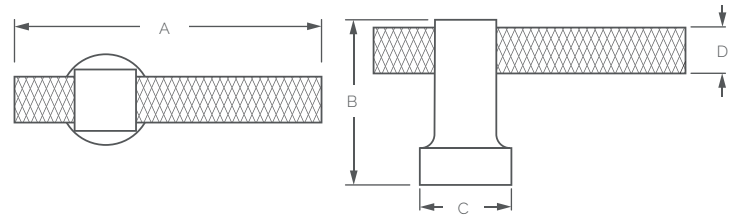

CABINET PULLS

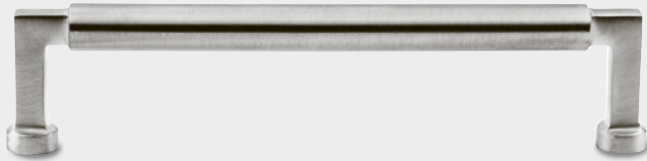

3906

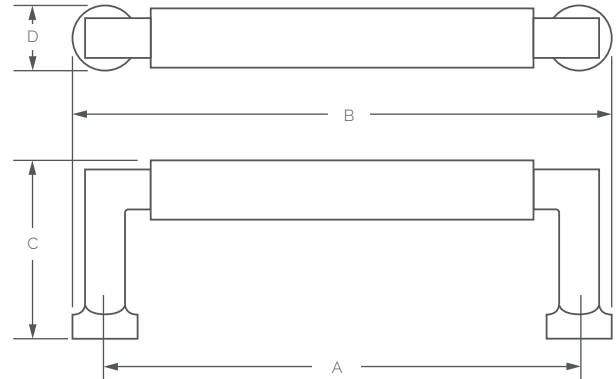

PRODUCT NUMBER	A	B	C	D
3904 Pull	4"	4-9/16"	1-1/2"	1/2"
3906 Pull	6"	6-9/16"	1-1/2"	1/2"
3908 Pull	8"	8-9/16"	1-1/2"	1/2"
3911 Pull	12"	12-9/16"	1-1/2"	1/2"
3917 Pull	18"	18-9/16"	1-1/2"	1/2"
3910 Appliance Pull	10"	10-31/32"	1-7/8"	15/16"
3912 Appliance Pull	12"	12-31/32"	1-7/8"	15/16"
3918 Appliance Pull	18"	18-31/32"	1-7/8"	15/16"
3924 Appliance Pull	24"	24-31/32"	1-7/8"	15/16"
3930 Appliance Pull	30"	30-31/32"	1-7/8"	15/16"
3936 Appliance Pull	36"	36-31/32"	1-7/8"	15/16"

REMEMBER

Custom c-c sizes available.

Split finishes available.

Appliance pulls are available as B-T-B and single sided applications.

CABINET PULLS

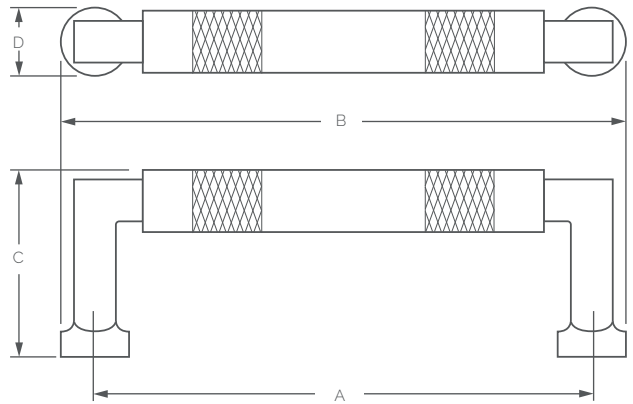
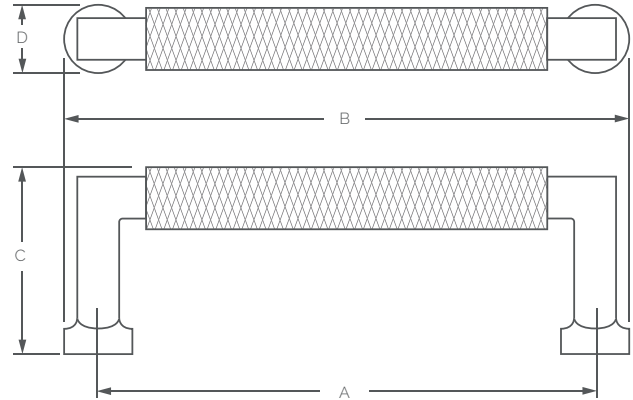

PRODUCT NUMBER	A	B	C	D
3964 Pull - Diamond	4"	4-9/16"	1-1/2"	1/2"
3966 Pull - Diamond	6"	6-9/16"	1-1/2"	1/2"
3968 Pull - Diamond	8"	8-9/16"	1-1/2"	1/2"
3972 Appliance Pull - Diamond	10"	10-31/32"	1-7/8"	15/16"
3978 Appliance Pull - Diamond	12"	12-31/32"	1-7/8"	15/16"
3984 Appliance Pull - Diamond Bands	18"	18-31/32"	1-7/8"	15/16"
3990 Appliance Pull - Diamond Bands	24"	24-31/32"	1-7/8"	15/16"
3996 Appliance Pull - Diamond Bands	30"	30-31/32"	1-7/8"	15/16"
3998 Appliance Pull - Diamond Bands	36"	36-31/32"	1-7/8"	15/16"

REMEMBER

Custom c-c sizes available.

Split finishes available.

Appliance pulls are available as B-T-B and single sided applications.

APRÈS

CUP PULLS



3926

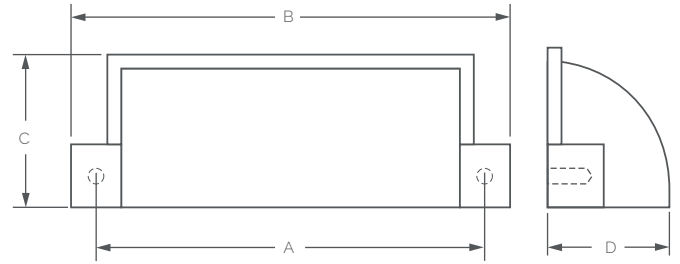

PRODUCT NUMBER	A	B	C	D
3926 Cup Pull	3-1/2"	3-31/32"	1-7/16"	1-3/32"



3927

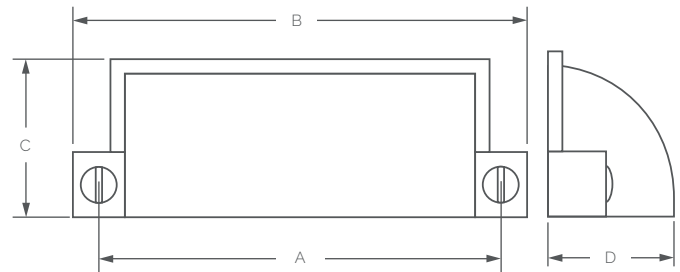

PRODUCT NUMBER	A	B	C	D
3927 Cup Pull w/ Exposed Screws	3-1/2"	3-31/32"	1-7/16"	1-3/32"

CUP PULLS



3929

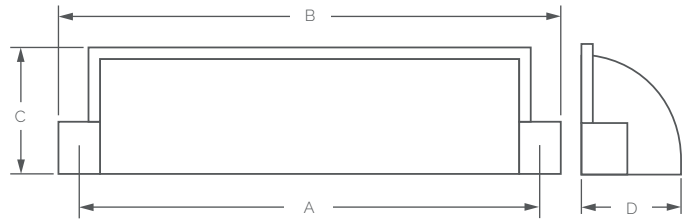

PRODUCT NUMBER	A	B	C	D
3929 Cup Pull	5"	5-7/16"	1-7/16"	1-3/32"



3931

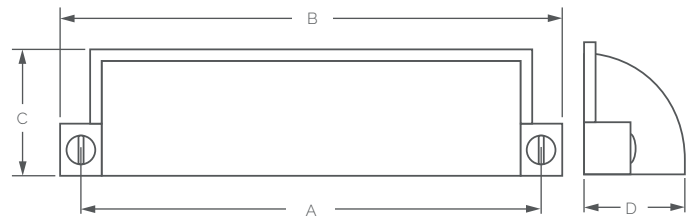

PRODUCT NUMBER	A	B	C	D
3931 Cup Pull w/ Exposed Screws	5"	5-7/16"	1-7/16"	1-3/32"

APRÈS

BACKPLATES



3933

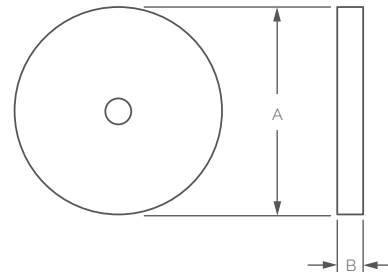

PRODUCT NUMBER	A	B
3933 Backplate	1-1/2"	3/16"

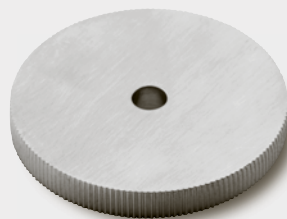

3939

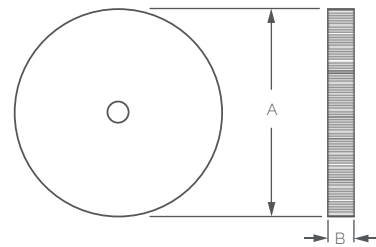

PRODUCT NUMBER	A	B
3939 Backplate - Coin	1-1/2"	3/16"

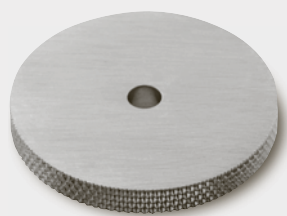

3940

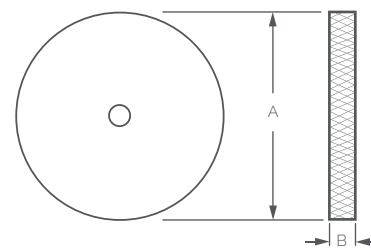

PRODUCT NUMBER	A	B
3940 Backplate - Cross Hatch	1-1/2"	3/16"

AVAILABLE IN ALL BRASS FINISHES

BACKPLATES



3935

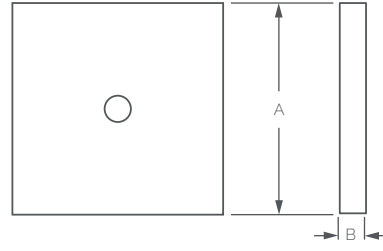

PRODUCT NUMBER	A	B
3935 Square Backplate	1-1/2"	3/16"



3937

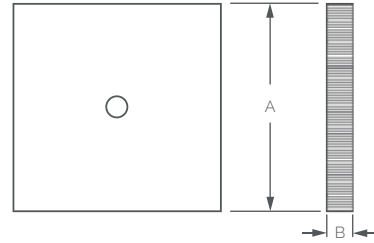

PRODUCT NUMBER	A	B
3937 Square Backplate - Coin	1-1/2"	3/16"



3938

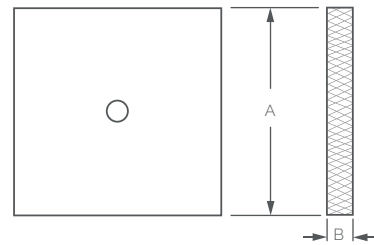

PRODUCT NUMBER	A	B
3938 Square Backplate - Cross Hatch	1-1/2"	3/16"



CABINET KNOBS & PULLS

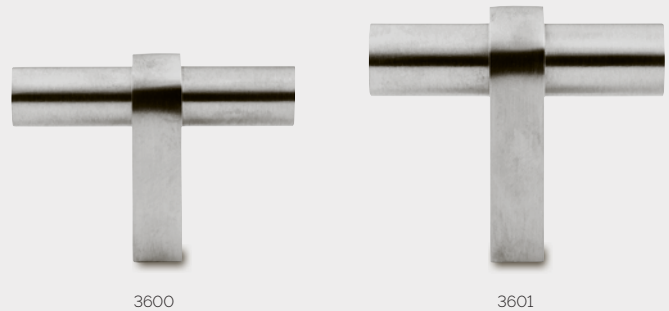

PRODUCT NUMBER	A	B	C	D
3600 T-Knob	1-3/4"	1-1/4"	9/16" X 5/16"	3/8"
3601 T-Knob	2"	1-11/16"	3/4" X 3/8"	1/2"

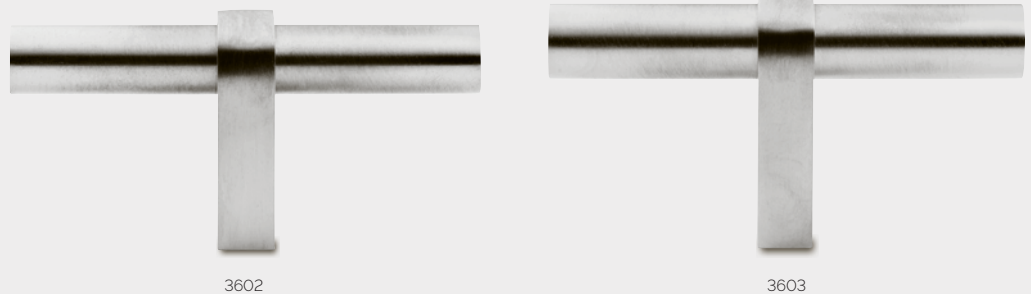
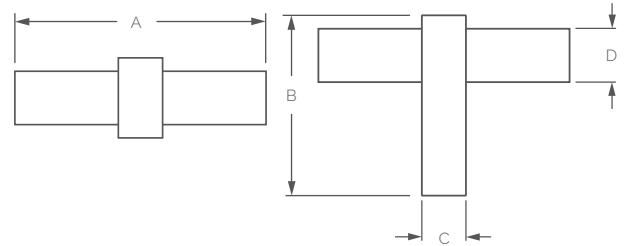

PRODUCT NUMBER	A	B	C	D
3602 T Pull	2-1/2"	1-1/4"	9/16" X 5/16"	3/8"
3603 T Pull	3-1/8"	1-11/16"	3/4" X 3/8"	1/2"

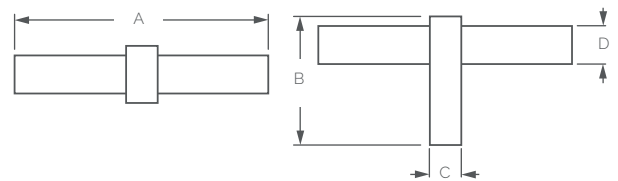

CABINET PULLS

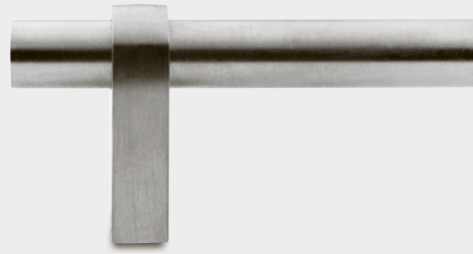

3605

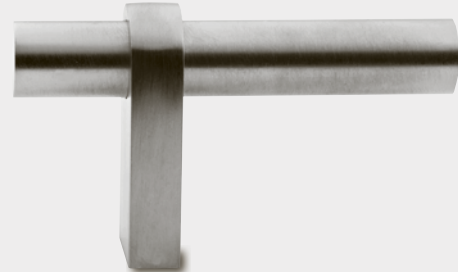

3607

PRODUCT NUMBER	A	B	C	D
3605 L Pull	2-1/2"	1-1/4"	9/16" X 5/16"	3/8"
3607 L Pull	3-1/8"	1-11/16"	3/4" X 3/8"	1/2"

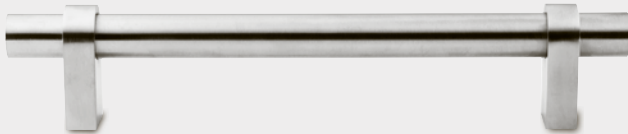
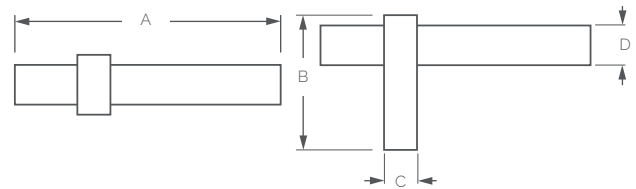

3606

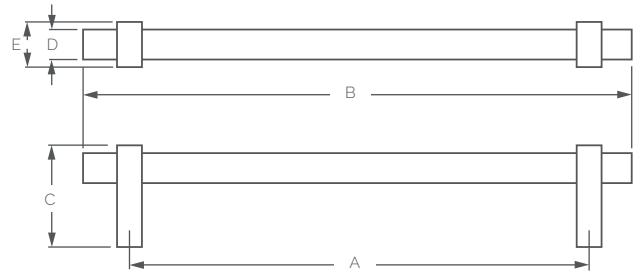

PRODUCT NUMBER	A	B	C	D	E
3604 Pull	4"	5-1/8"	1-11/16"	1/2"	3/4" X 3/8"
3606 Pull	6"	7-1/8"	1-11/16"	1/2"	3/4" X 3/8"
3608 Pull	8"	9-1/8"	1-11/16"	1/2"	3/4" X 3/8"
3611 Pull	12"	13-1/8"	1-11/16"	1/2"	3/4" X 3/8"
3617 Pull	18"	19-1/8"	1-11/16"	1/2"	3/4" X 3/8"
3612 Appliance Pull	12"	14-5/8"	2-3/4"	7/8"	1-1/4" X 5/8"
3618 Appliance Pull	18"	20-5/8"	2-3/4"	7/8"	1-1/4" X 5/8"
3624 Appliance Pull	24"	26-5/8"	2-3/4"	7/8"	1-1/4" X 5/8"
3630 Appliance Pull	30"	32-5/8"	2-3/4"	7/8"	1-1/4" X 5/8"
3636 Appliance Pull	36"	38-5/8"	2-3/4"	7/8"	1-1/4" X 5/8"

REMEMBER

Custom c-c sizes available.

Split finishes available.

Appliance pulls are available as B-T-B and single sided applications.



CABINET KNOBS & PULLS

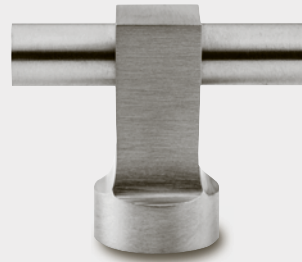

4030

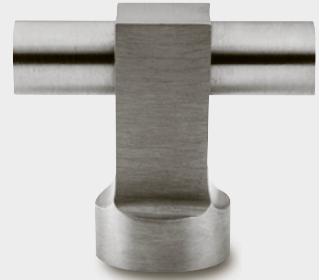

4031

PRODUCT NUMBER	A	B	C	D
4030 T Knob - Square	1-3/4"	1-3/8"	3/4"	3/8"
4031 T Knob - Square	2"	1-11/16"	15/16"	1/2"

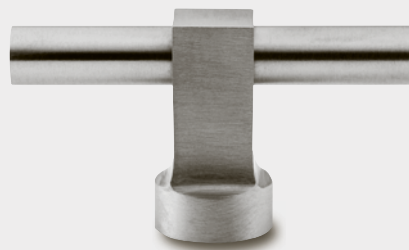
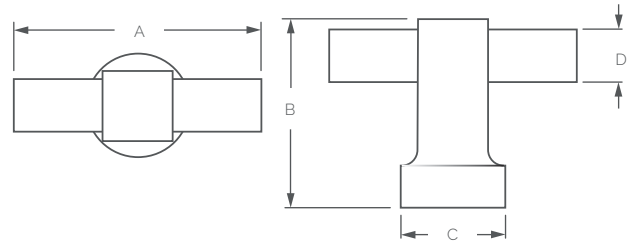

4032

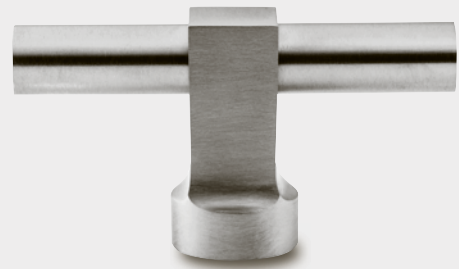

4033

PRODUCT NUMBER	A	B	C	D
4032 T Pull - Square	2-1/2"	1-3/8"	3/4"	3/8"
4033 T Pull - Square	3-1/8"	1-11/16"	15/16"	1/2"

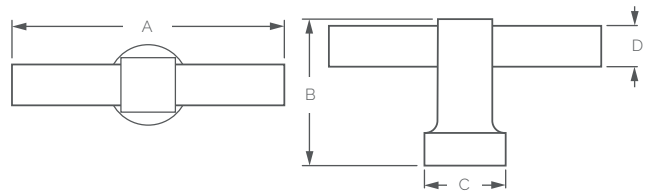

CABINET PULLS

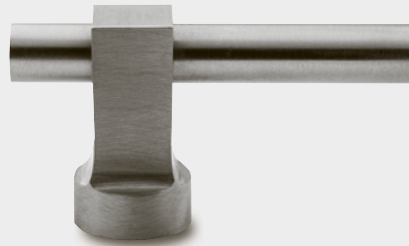

4037

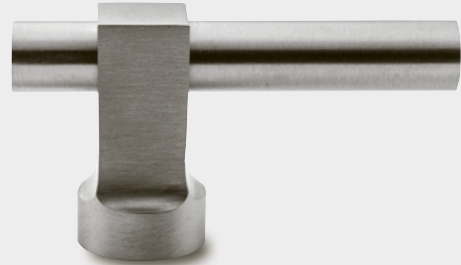

4039

PRODUCT NUMBER	A	B	C	D
4037 L Pull - Square	2-1/2"	1-3/8"	3/4"	3/8"
4039 L Pull - Square	3-1/8"	1-11/16"	15/16"	1/2"

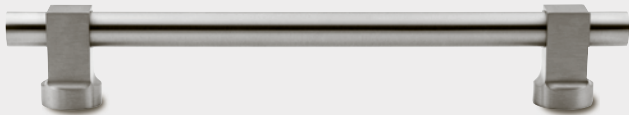
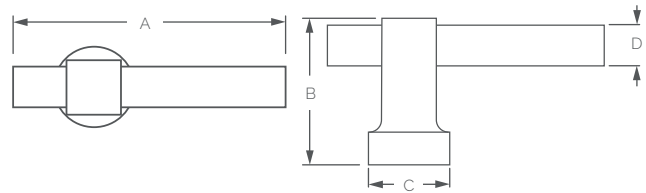

4046

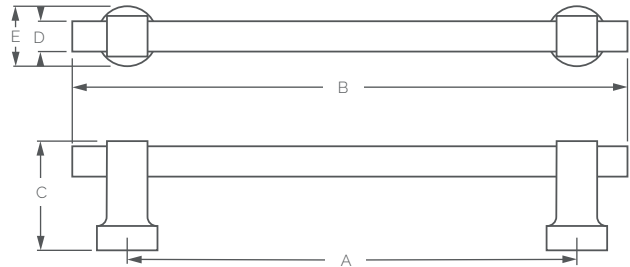

PRODUCT NUMBER	A	B	C	D	E
4044 Pull	4"	5-3/8"	1-11/16"	1/2"	15/16"
4046 Pull	6"	7-3/8"	1-11/16"	1/2"	15/16"
4048 Pull	8"	9-3/8"	1-11/16"	1/2"	15/16"
4051 Pull	12"	13-3/8"	1-11/16"	1/2"	15/16"
4057 Pull	18"	19-3/8"	1-11/16"	1/2"	15/16"
4062 Appliance Pull	12"	15-1/16"	2-3/8"	7/8"	1-1/2"
4068 Appliance Pull	18"	21-1/16"	2-3/8"	7/8"	1-1/2"
4074 Appliance Pull	24"	27-1/16"	2-3/8"	7/8"	1-1/2"
4080 Appliance Pull	30"	33-1/16"	2-3/8"	7/8"	1-1/2"
4086 Appliance Pull	36"	39-1/16"	2-3/8"	7/8"	1-1/2"

REMEMBER

Custom c-c sizes available.

Split finishes available.

Appliance pulls are available as B-T-B and single sided applications.



CABINET KNOBS & PULLS

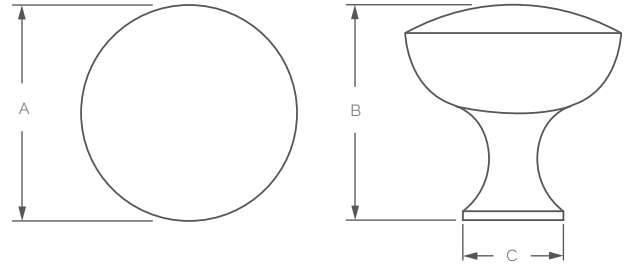

PRODUCT NUMBER	A	B	C
3701 Knob	1-1/4"	1-1/4"	9/16"
3703 Knob	1-1/2"	1-1/2"	11/16"

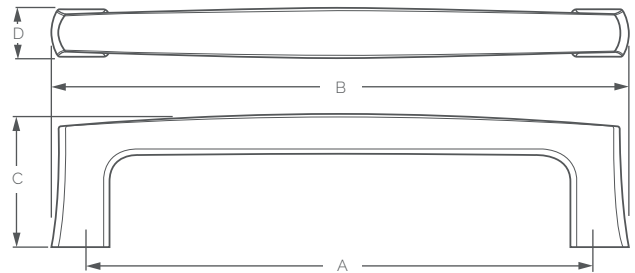

PRODUCT NUMBER	A	B	C	D
3704 Pull	4"	4-27/32"	1-19/32"	9/16"
3706 Pull	6"	6-27/32"	1-19/32"	9/16"
3708 Pull	8"	8-27/32"	1-19/32"	9/16"
3711 Pull	12"	12-27/32"	1-19/32"	9/16"
3717 Pull	18"	18-27/32"	1-19/32"	9/16"
3712 Appliance Pull	12"	13-3/16"	2-1/8"	1"
3718 Appliance Pull	18"	19-3/16"	2-1/8"	1"

REMEMBER

Appliance pulls are available as B-T-B and single sided applications.



CABINET KNOBS & PULLS



3800



3801

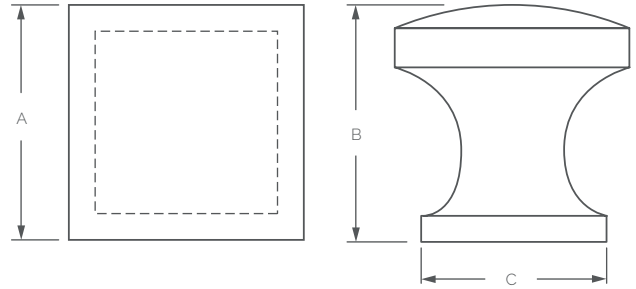

PRODUCT NUMBER	A	B	C
3800 Square Knob	1-1/8"	1-1/8"	7/8"
3801 Square Knob	1-3/8"	1-3/8"	1-1/16"

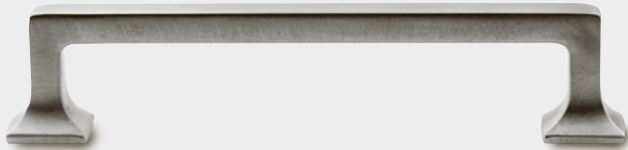

3806

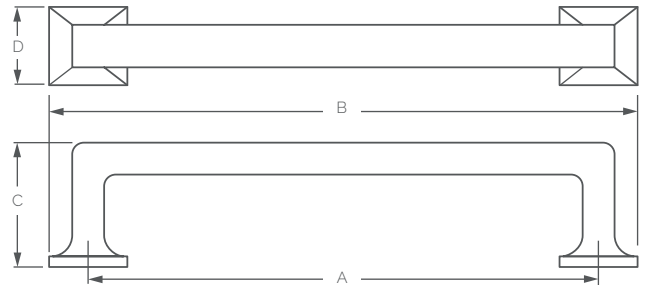

PRODUCT NUMBER	A	B	C	D
3804 Pull	4"	4-15/16"	1-15/32"	15/16"
3806 Pull	6"	6-15/16"	1-15/32"	15/16"
3808 Pull	8"	8-15/16"	1-15/32"	15/16"
3811 Pull	12"	12-15/16"	1-15/32"	15/16"
3817 Pull	18"	18-15/16"	1-15/32"	15/16"
3812 Appliance Pull	12"	13-1/4"	2-3/32"	1-1/4"
3818 Appliance Pull	18"	19-1/4"	2-3/32"	1-1/4"

REMEMBER

Appliance pulls are available as B-T-B and single sided applications.



CABINET KNOBS & PULLS



1600



1601

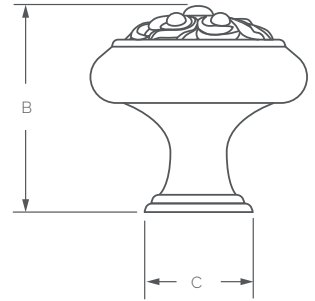
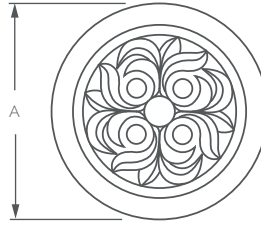

PRODUCT NUMBER	A	B	C
1600 Knob	1-1/4"	1-3/16"	5/8"
1601 Knob	1-1/2"	1-11/32"	3/4"



1604

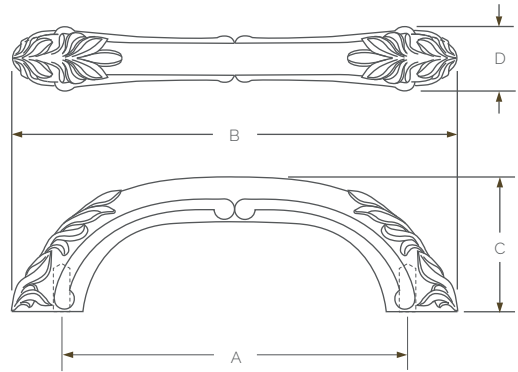

PRODUCT NUMBER	A	B	C	D
1603 Pull	3"	3-7/8"	1-3/16"	9/16"
1604 Pull	4"	4-7/8"	1-3/16"	5/8"



1605

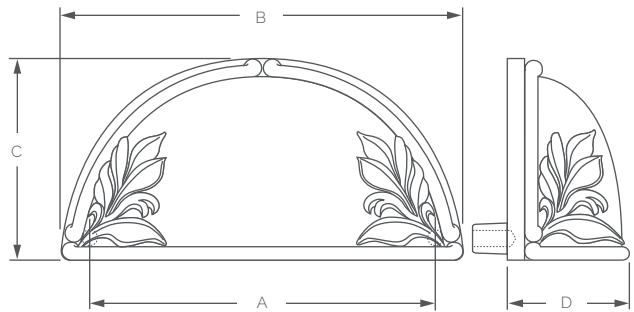

PRODUCT NUMBER	A	B	C	D
1605 Cup Pull	3"	3-1/2"	1-3/4"	1-1/16"

BACKPLATES

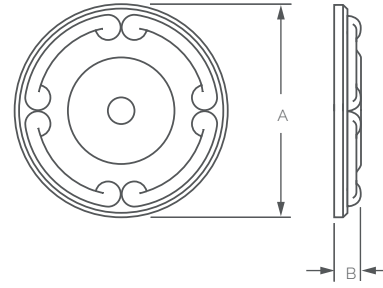

PRODUCT NUMBER	A	B
1606 Backplate	1-1/2"	3/16"
1607 Backplate	1-3/4"	3/16"



CABINET KNOBS & PULLS



1556

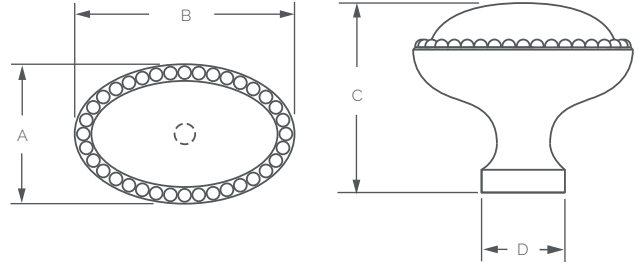

PRODUCT NUMBER	A	B	C	D
1556 Oval Knob	15/16"	1-7/16"	1-1/4"	3/4"

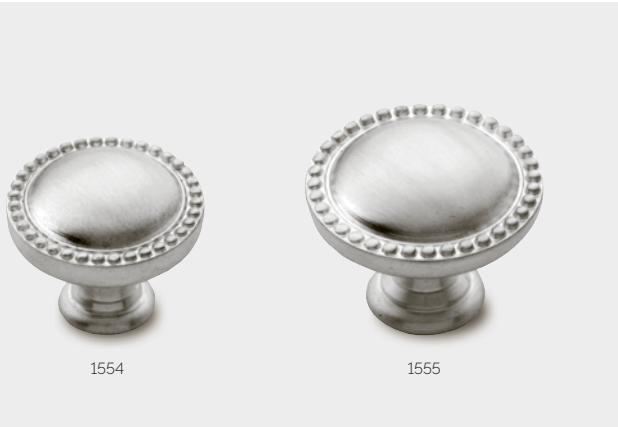

1554

1555

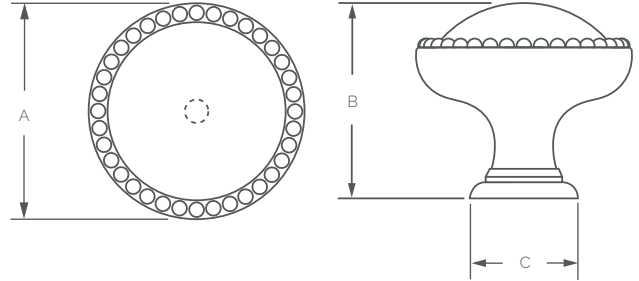

PRODUCT NUMBER	A	B	C
1554 Knob	1-1/4"	1-1/8"	5/8"
1555 Knob	1-1/2"	1-1/4"	3/4"



1558

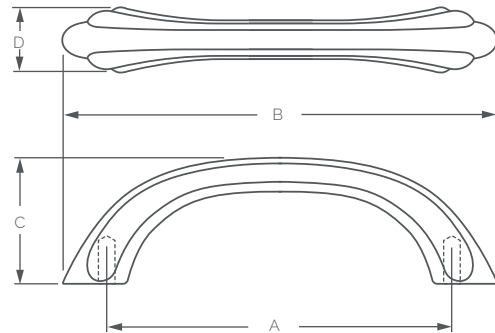

PRODUCT NUMBER	A	B	C	D
1557 Pull	3"	3-3/4"	1-3/32"	9/16"
1558 Pull	4"	4-7/8"	1-3/16"	5/8"

CUP PULLS & BACKPLATES



1559

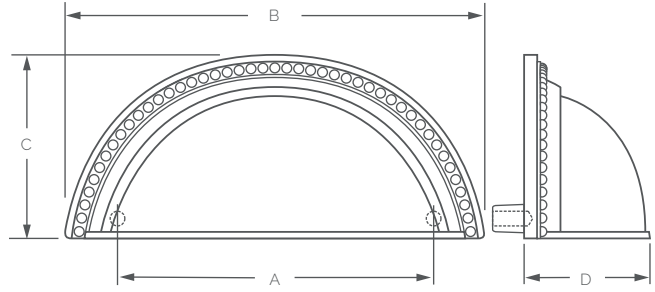

PRODUCT NUMBER	A	B	C	D
1559 Cup Pull	3"	4"	1-3/4"	1-3/16"

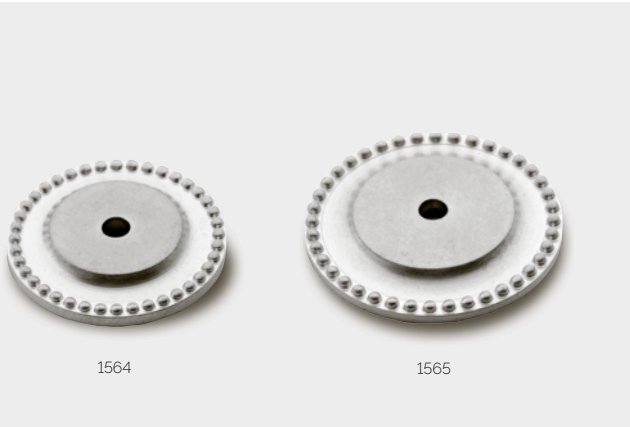

1564

1565

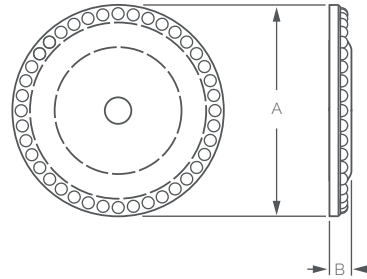

PRODUCT NUMBER	A	B
1564 Backplate	1-1/2"	5/32"
1565 Backplate	1-3/4"	5/32"



1567

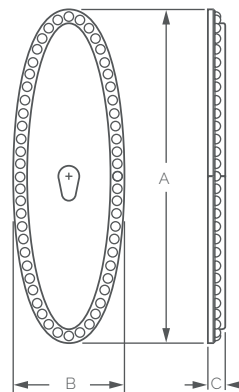

PRODUCT NUMBER	A	B	C
1567 Oval Backplate	3"	1"	5/32"



CABINET KNOBS & PULLS



1401



1402

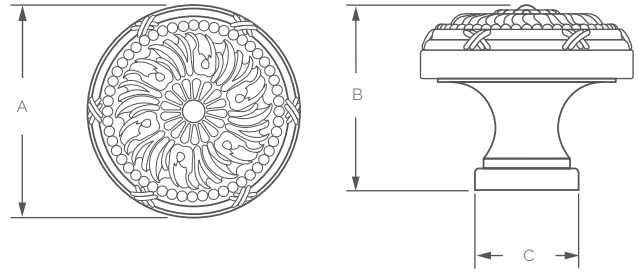

PRODUCT NUMBER	A	B	C
1401 Knob	1-1/4"	1-1/8"	19/32"
1402 Knob	1-1/2"	1-5/16"	21/32"



1451



1452

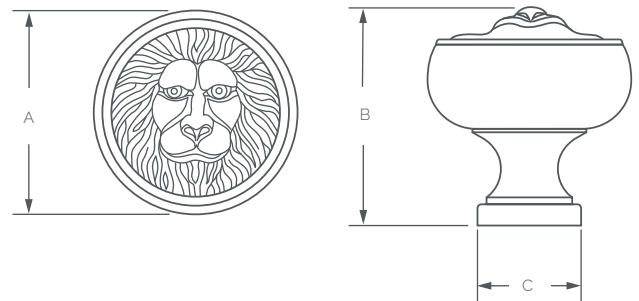

PRODUCT NUMBER	A	B	C
1451 Lion Knob	1-1/4"	1-5/16"	5/8"
1452 Lion Knob	1-1/2"	1-1/2"	5/8"



1404

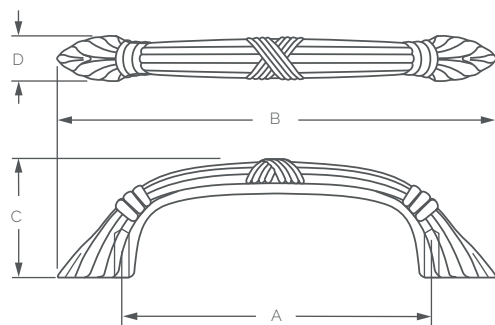

PRODUCT NUMBER	A	B	C	D
1403 Pull	3"	3-1/4"	1-1/8"	13/32"
1404 Pull	3-1/2"	4-3/4"	1-5/32"	7/16"

CUP PULLS & BACKPLATES



1405

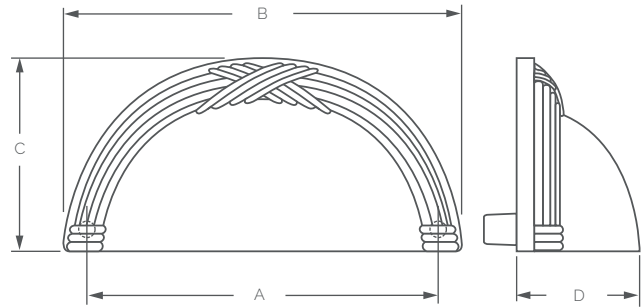

PRODUCT NUMBER	A	B	C	D
1405 Cup Pull	3"	3-7/16"	1-5/8"	1-7/16"



1450

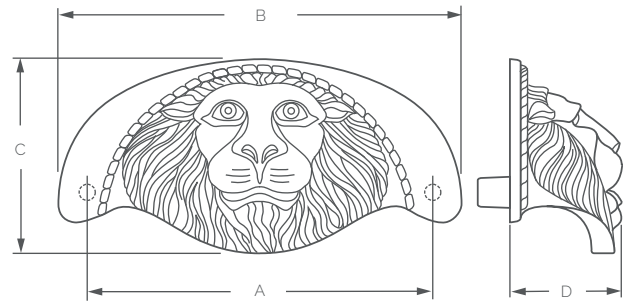

PRODUCT NUMBER	A	B	C	D
1450 Lion Cup Pull	3"	3-1/2"	1-5/8"	1"



1406



1407

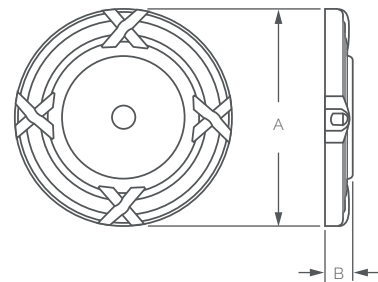

PRODUCT NUMBER	A	B
1406 Backplate	1-1/2"	7/32"
1407 Backplate	1-3/4"	7/32"

APPLIANCE PULLS



8089

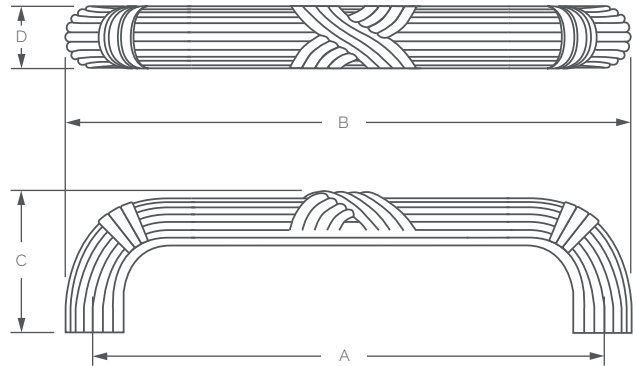

PRODUCT NUMBER	A	B	C	D
8089 Appliance Pull	8"	9"	2-1/4"	1"

REMEMBER

Appliance pulls are available as B-T-B and single sided applications.



CABINET KNOBS & PULLS

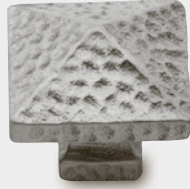

1522

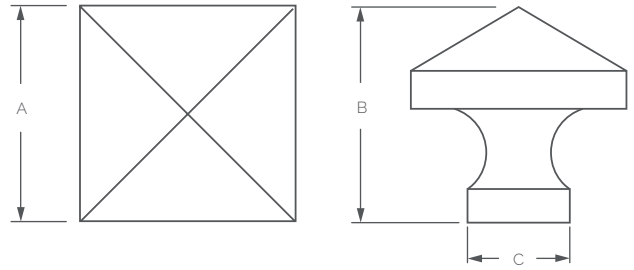

PRODUCT NUMBER	A	B	C
1522 Square Knob	1-1/4"	1-7/32"	9/16"

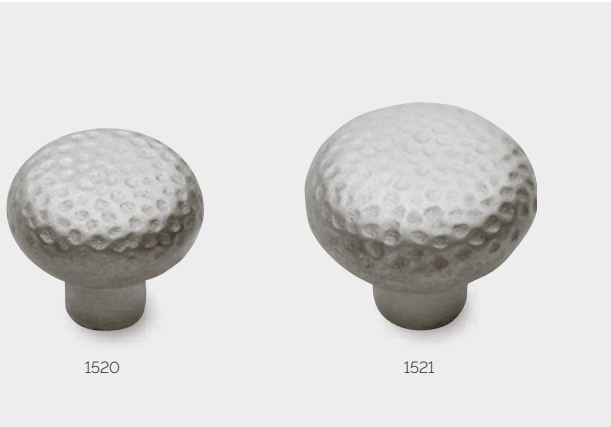

1520

1521

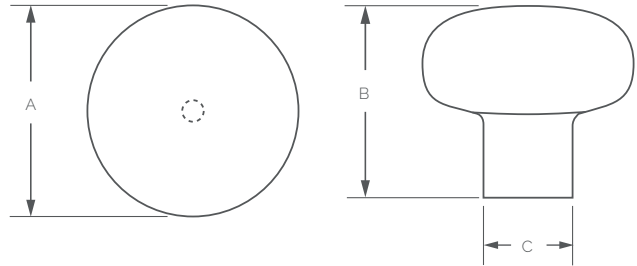

PRODUCT NUMBER	A	B	C
1520 Knob	1-3/8"	1-1/4"	9/16"
1521 Knob	1-5/8"	1-3/8"	11/16"



1524

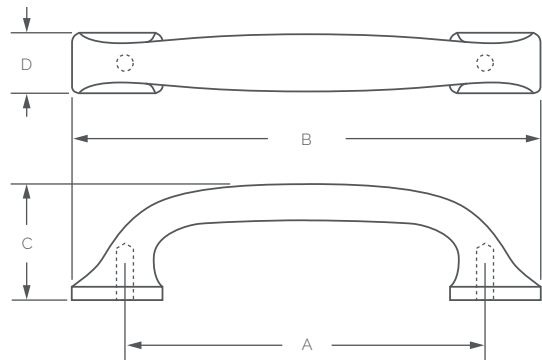

PRODUCT NUMBER	A	B	C	D
1523 Pull	3"	3-7/8"	15/16"	1/2"
1524 Pull	4"	4-7/8"	1-1/8"	9/32"

CUP PULLS & BACKPLATES

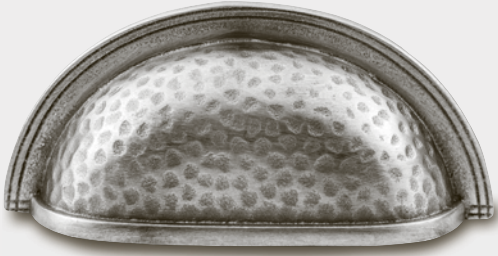

1525

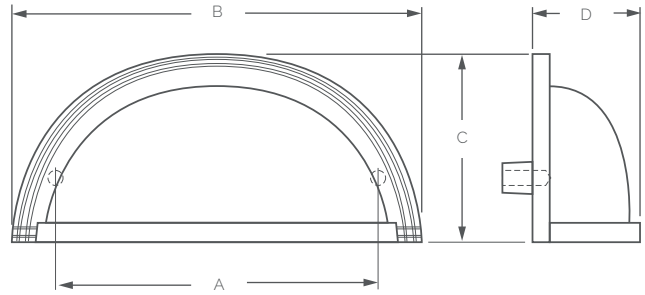

PRODUCT NUMBER	A	B	C	D
1525 Cup Pull	3"	3-3/4"	1-3/4"	1-5/16"

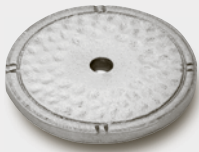

1526

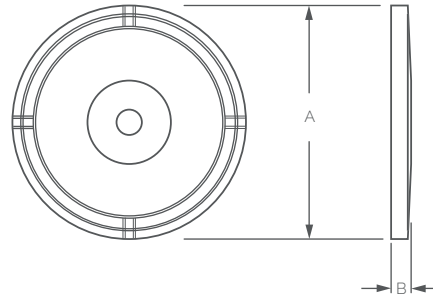

PRODUCT NUMBER	A	B
1526 Backplate	1-5/8"	5/32"



1527

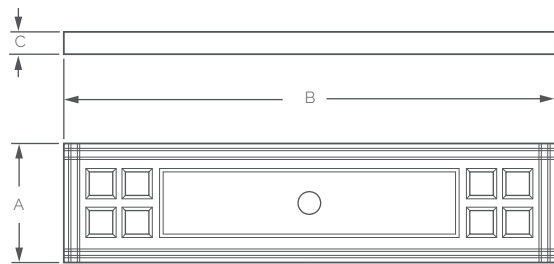

PRODUCT NUMBER	A	B	C
1527 Backplate	1"	4-1/8"	3/16"

BACKPLATES & APPLIANCE PULLS

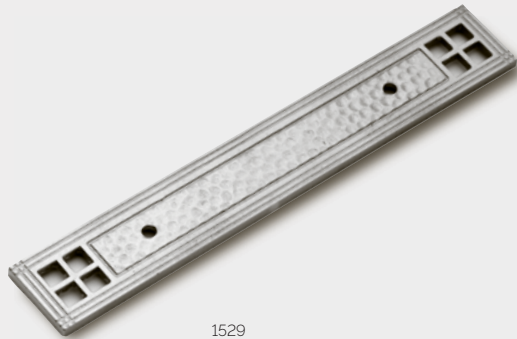

1529

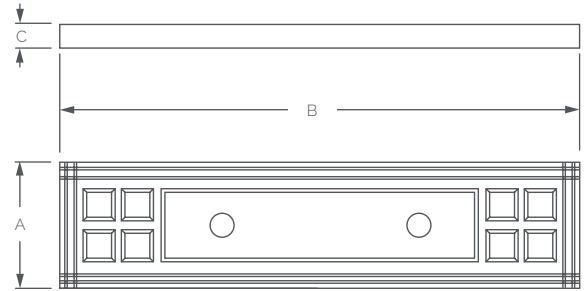

PRODUCT NUMBER	A	B	C
1528 Backplate (3" c-c)	1"	6-1/2"	3/16"
1529 Backplate (4" c-c)	1-1/8"	7-1/2"	3/16"



8689

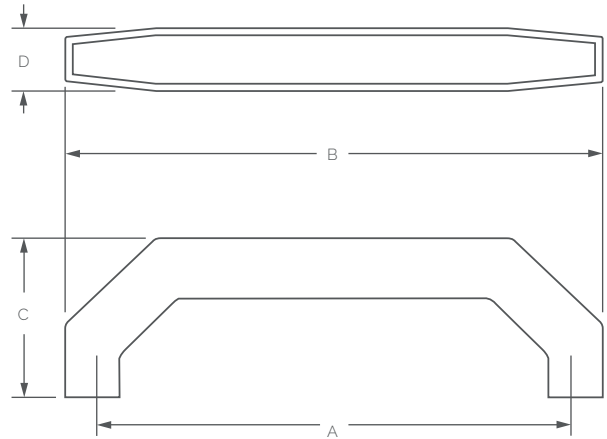

PRODUCT NUMBER	A	B	C	D
8689 Appliance Pull	6-1/2"	7-3/8"	2-3/16"	7/8"

REMEMBER

Appliance pulls are available as B-T-B and single sided applications.



CABINET KNOBS



1464

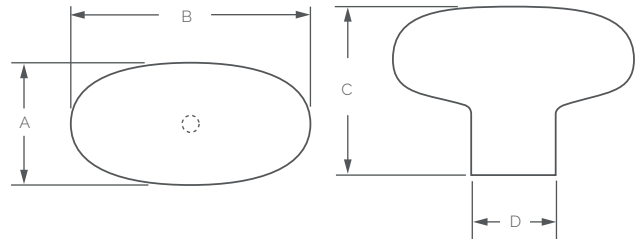

PRODUCT NUMBER	A	B	C	D
1464 Oval Knob	31/32"	1-29/32"	1-3/8"	11/16"



1462

1463

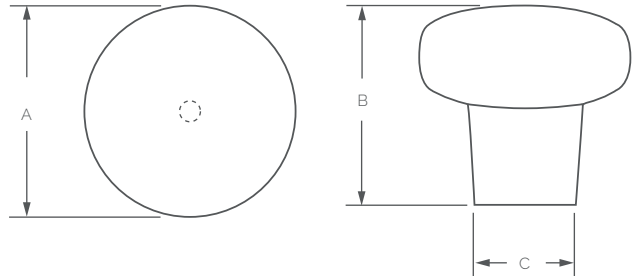

PRODUCT NUMBER	A	B	C
1462 Knob	1-3/8"	1-5/16"	11/16"
1463 Knob	1-5/8"	1-3/8"	3/4"



1460

1461

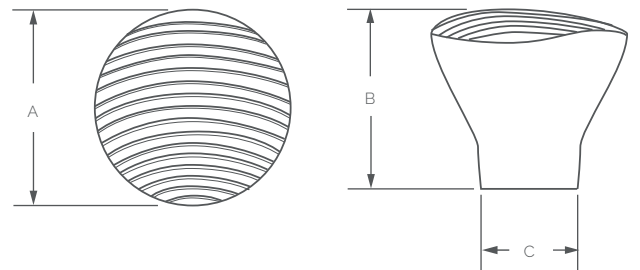

PRODUCT NUMBER	A	B	C
1460 Knob	1-1/4"	1-5/32"	19/32"
1461 Knob	1-1/2"	1-9/32"	11/16"

CABINET PULLS

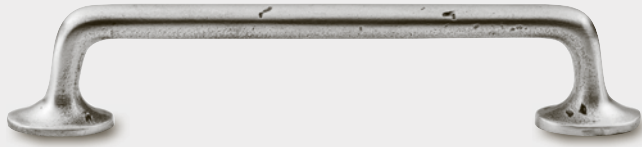

1471

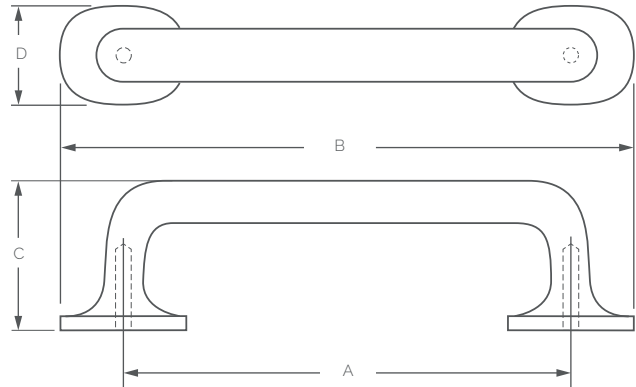

PRODUCT NUMBER	A	B	C	D
1470 Pull	4"	5-1/4"	1-11/32"	7/8"
1471 Pull	6"	7-1/4"	1-7/16"	15/16"
1473 Appliance Pull	12"	13-1/4"	1-9/16"	1"
1475 Appliance Pull	18"	20"	2"	1-3/8"

REMEMBER

Appliance pulls are available as B-T-B and single sided applications.



1465

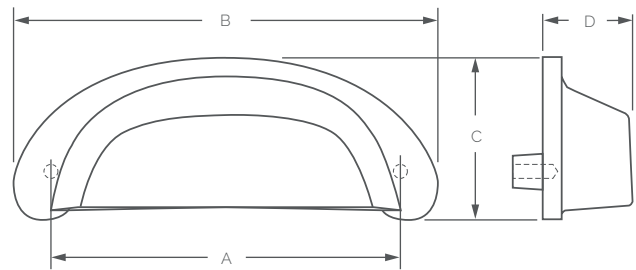

PRODUCT NUMBER	A	B	C	D
1465 Cup Pull	3-1/2"	4-1/4"	1-5/8"	7/8"

BACKPLATES



1466

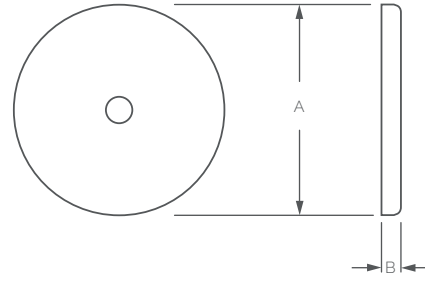

PRODUCT NUMBER	A	B
1466 Backplate	1-5/8"	5/32"



MORTISE

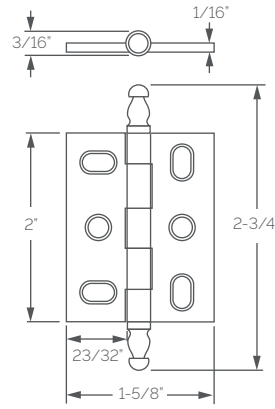
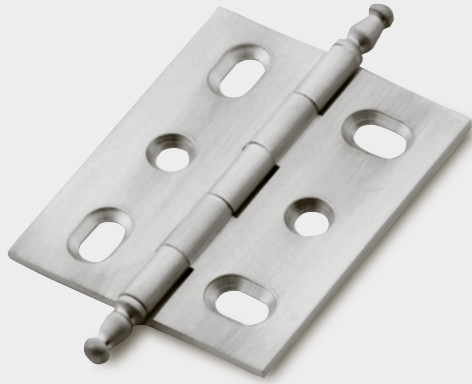

1516
Hinge: Mortise
Finial: Minarette

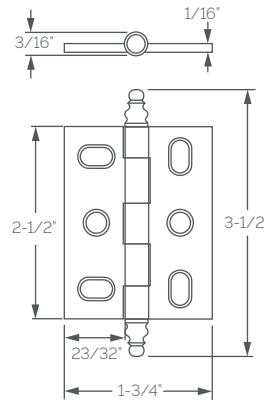
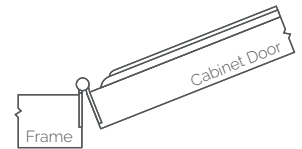

1517
Hinge: Mortise
Finial: Minarette

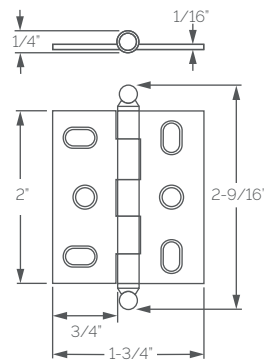
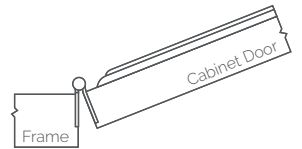

2501
Hinge: Mortise
Finial: Ball

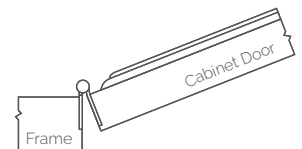

MORTISE

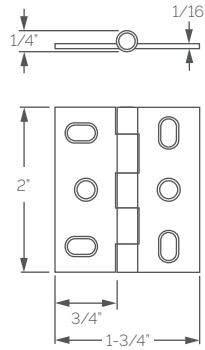

2505
Hinge: Mortise
Finial: Flush

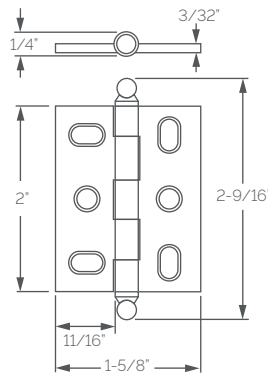
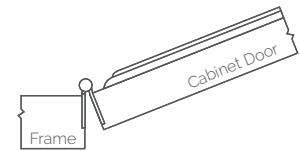

2571
Hinge: Mortise
Finial: Ball

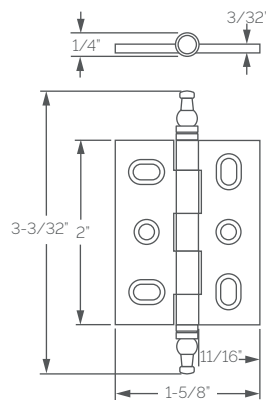
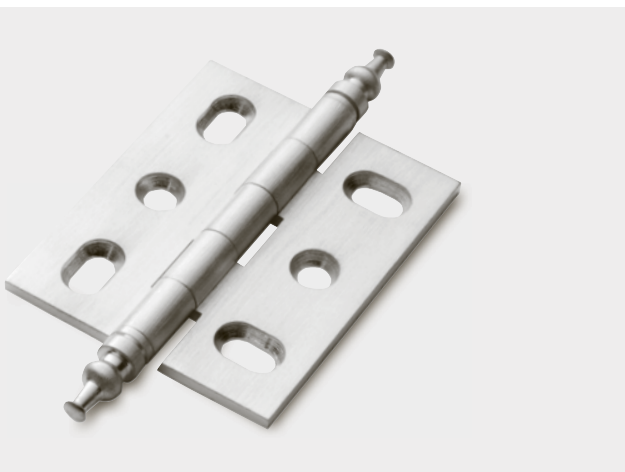
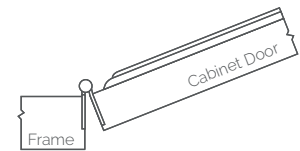

2572
Hinge: Mortise
Finial: Minarette

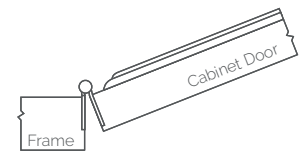

MORTISE

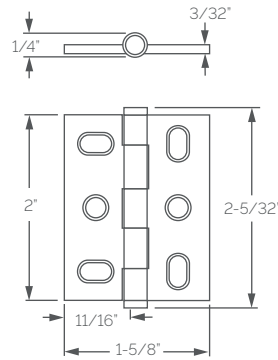

2575
Hinge: Mortise
Finial: Button

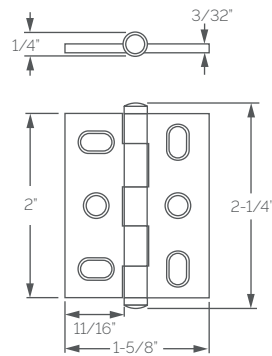
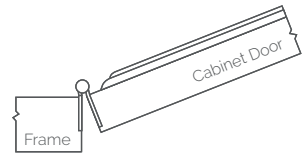

2576
Hinge: Mortise
Finial: Dome

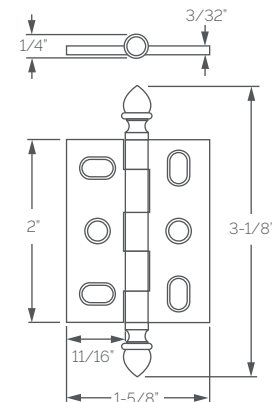
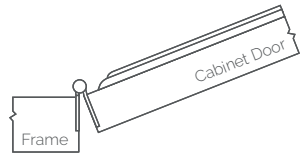

2577
Hinge: Mortise
Finial: Cathedral

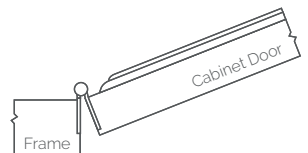

NON-MORTISE

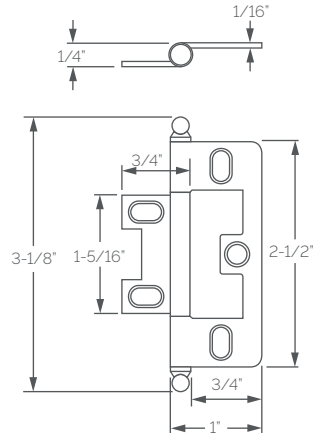
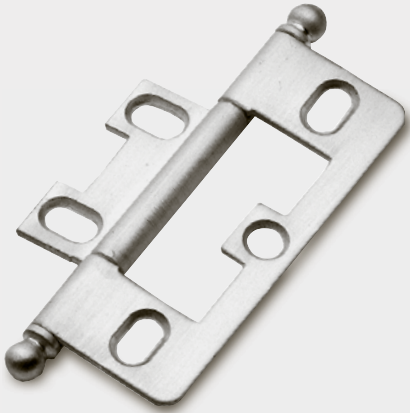

2511
Hinge: Non-Mortise
Finial: Ball

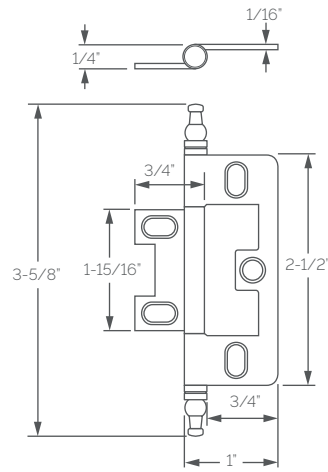
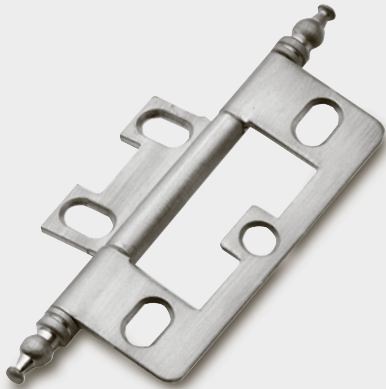
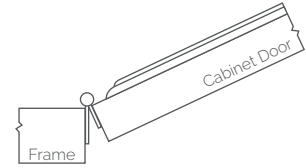

2512
Hinge: Non-Mortise
Finial: Minarette

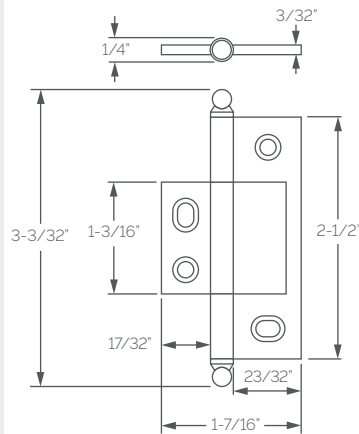
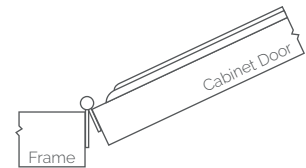

2581
Hinge: Non-Mortise
Finial: Ball

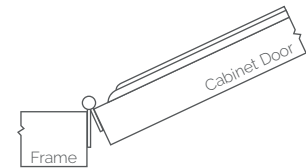

NON-MORTISE

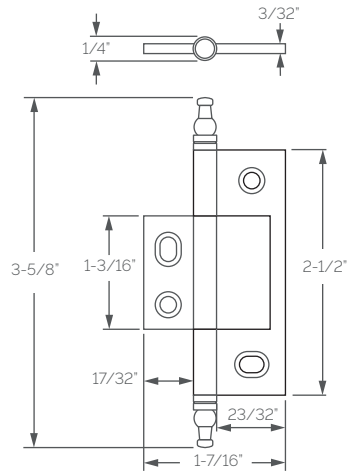
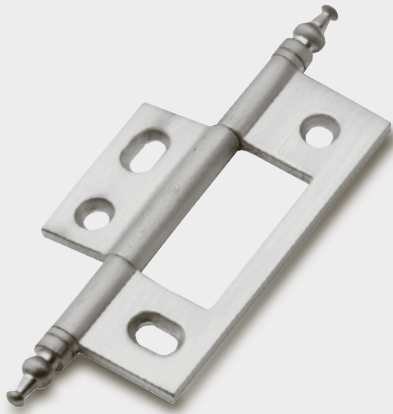

2582
Hinge: Non-Mortise
Finial: Minarette

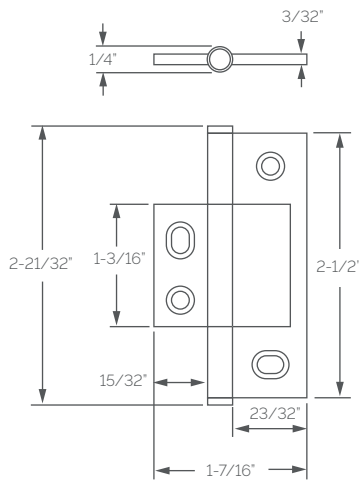
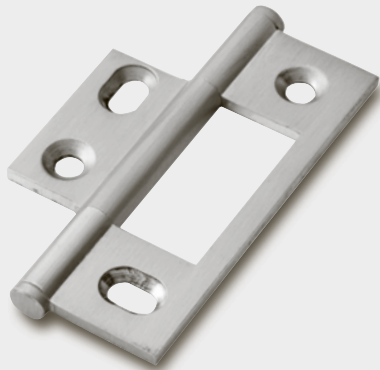
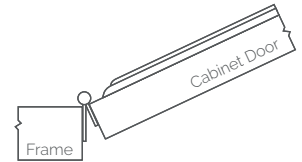

2585
Hinge: Non-Mortise
Finial: Button

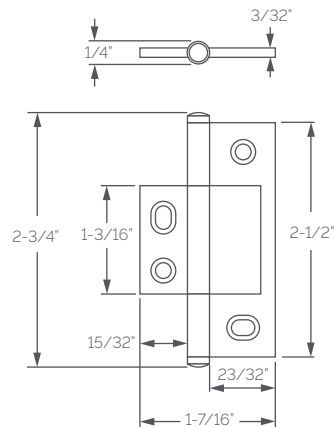
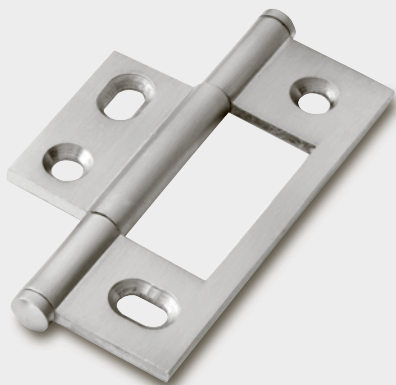
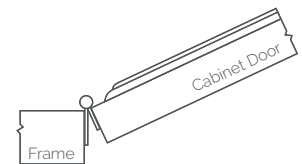

2586
Hinge: Non-Mortise
Finial: Dome

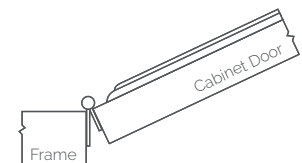

NON-MORTISE

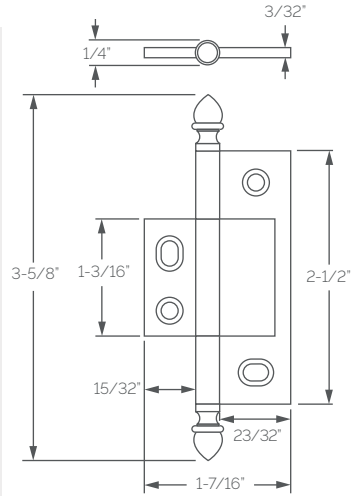
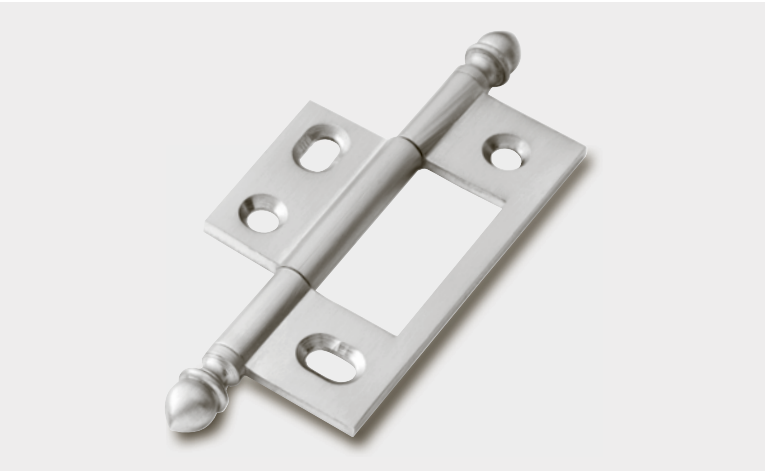

2587
Hinge: Non-Mortise
Finial: Cathedral

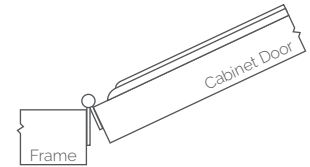

3/8" OFFSET

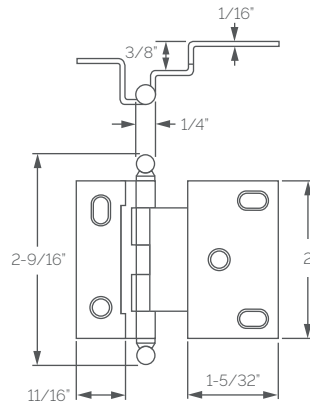
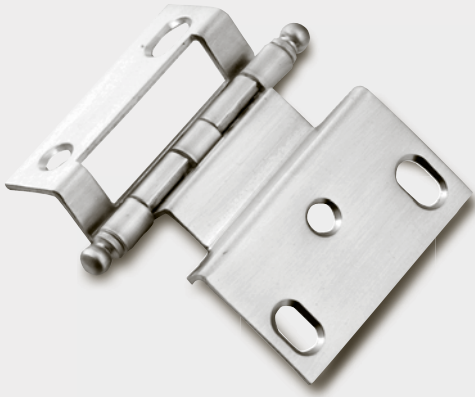

2541
Hinge: 3/8" Offset
Finial: Ball

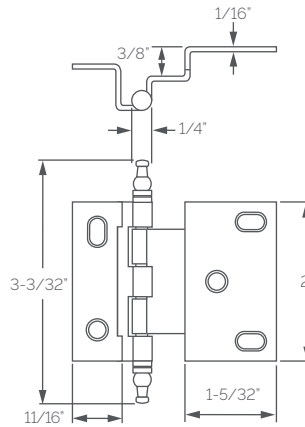
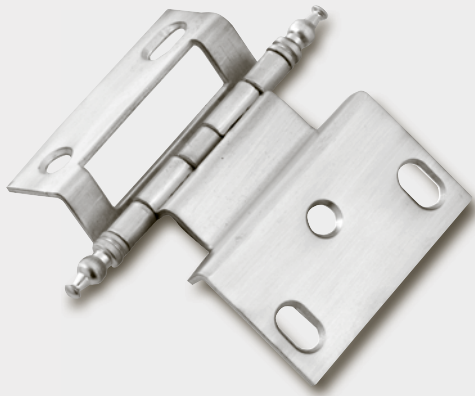
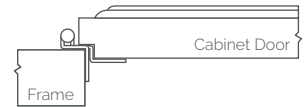

2542
Hinge: 3/8" Offset
Finial: Minarette

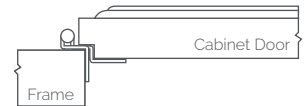

3/4" INSET FULL WRAP

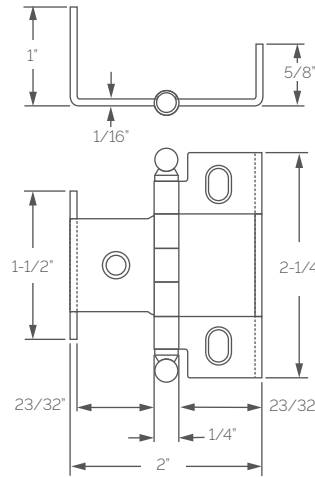
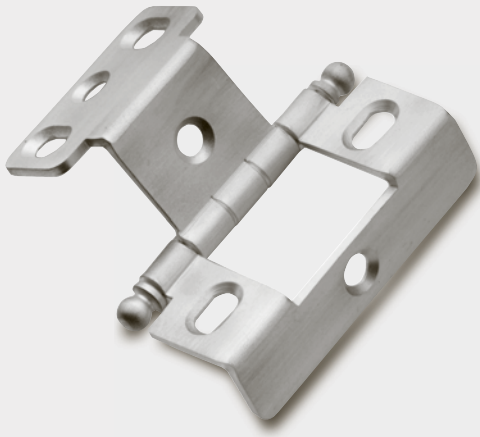

2551
Hinge: 3/4" Inset Full Wrap
Finial: Ball

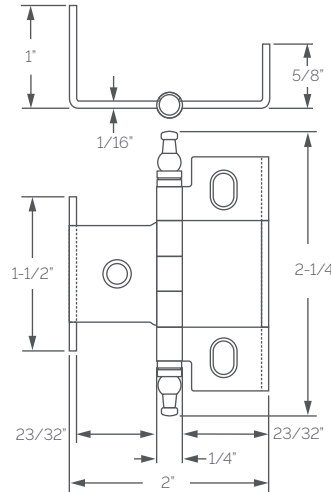
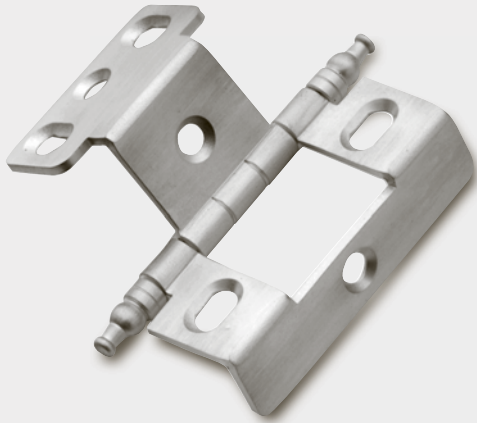
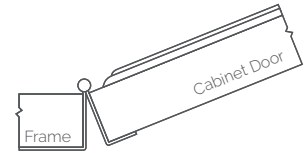

2552
Hinge: 3/4" Inset Full Wrap
Finial: Minarette

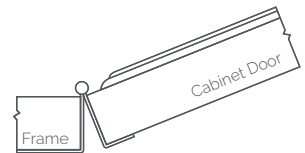

3/4" INSET PARTIAL WRAP

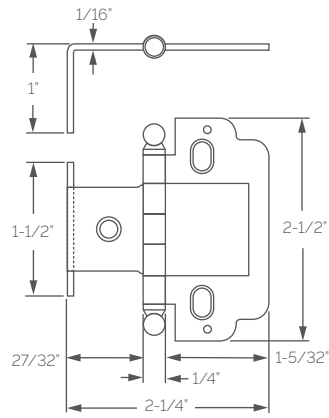
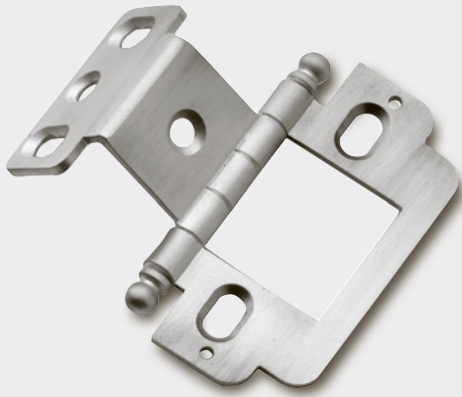

2561

Hinge: 3/4" Inset Partial Wrap
Finial: Ball

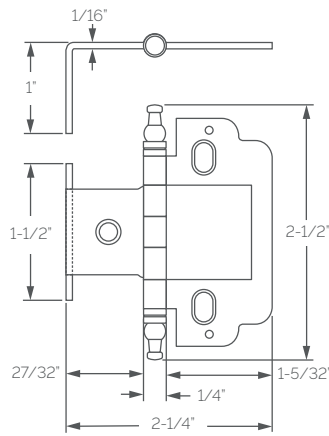
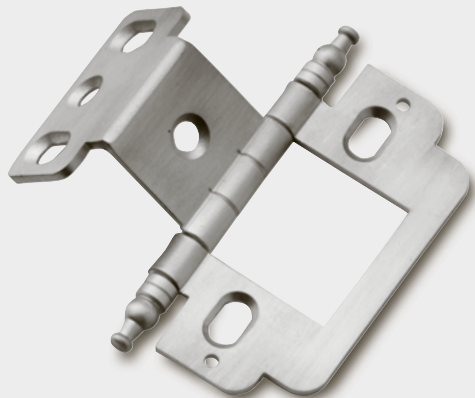
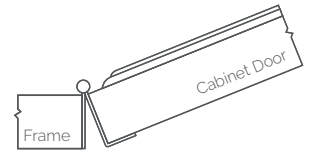

2562

Hinge: 3/4" Inset Partial Wrap
Finial: Minarette

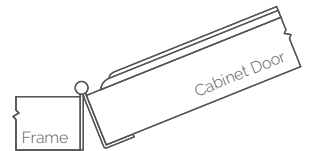

SURFACE

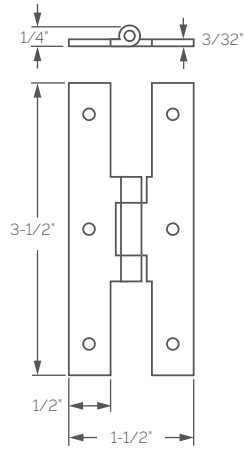

1094
Hinge: Surface

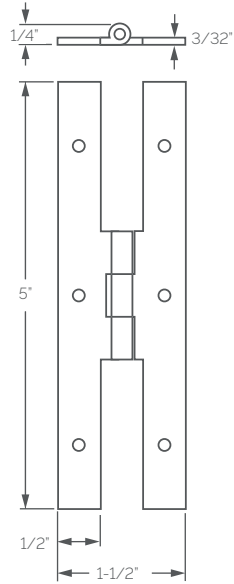
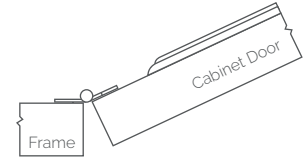

1096
Hinge: Surface

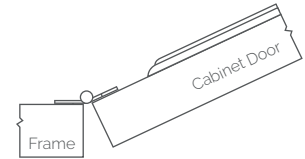

LIFT OFF

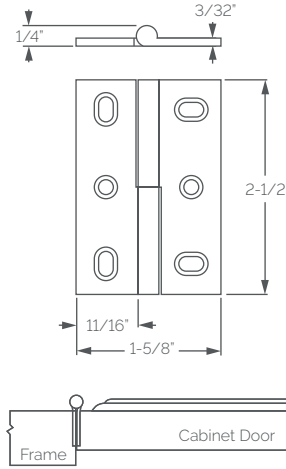

2590RH
Hinge: Right Hand

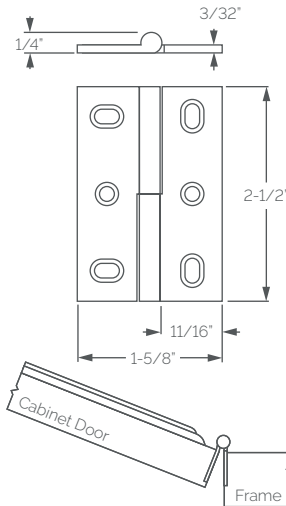

2590LH
Hinge: Left Hand



CABINET KNOBS



2870



2871

PRODUCT NUMBER	A	B	C	D
2870 Oval Knob	7/8"	7/8" x 1-1/4"	1-1/8"	5/8"
2871 Oval Knob	31/32"	1-3/8" x 31/32"	1-1/4"	5/8"

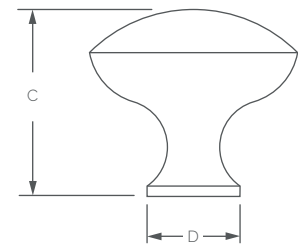
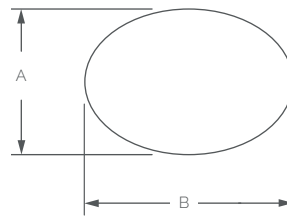

2864



2866



2868

PRODUCT NUMBER	A	B	C
2864 Knob	1"	31/32"	3/8"
2866 Knob	1-1/4"	1-3/16"	1/2"
2868 Knob	1-1/2"	1-7/16"	9/16"

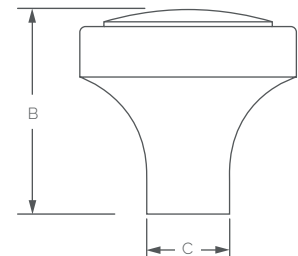
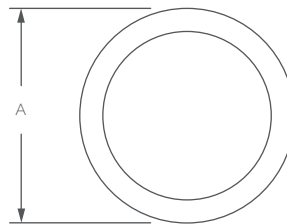

CABINET PULLS

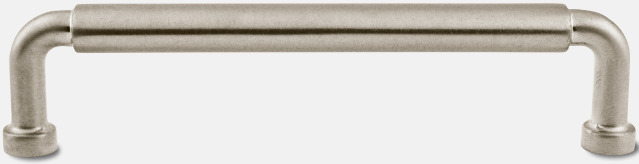

2876

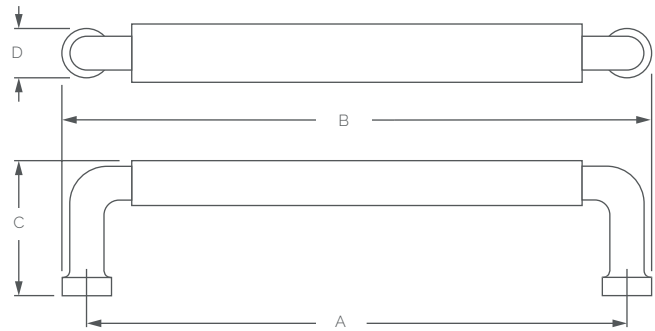

PRODUCT NUMBER	A	B	C	D
2874 Oval Pull	4"	4-9/16"	1-1/2"	9/16"
2876 Oval Pull	6"	6-9/16"	1-1/2"	9/16"
2878 Oval Pull	8"	8-9/16"	1-1/2"	9/16"
2882 Oval Pull	12"	12-9/16"	1-1/2"	9/16"
2888 Oval Pull	18"	18-9/16"	1-1/2"	9/16"
2892 Oval Appliance Pull	12"	13-3/32"	2-1/4"	1-3/32"
2898 Oval Appliance Pull	18"	19-3/32"	2-1/4"	1-3/32"

REMEMBER

Appliance pulls are available as B-T-B and single sided applications.

BACKPLATES



2872

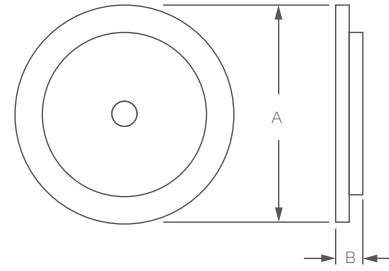

PRODUCT NUMBER	A	B
2872 Backplate	1-1/2"	3/16"



2873

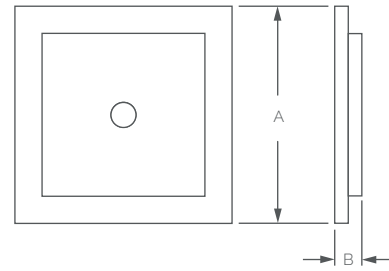

PRODUCT NUMBER	A	B
2873 Square Backplate	1-1/2"	3/16"



CABINET KNOBS



2203



2205



2207

PRODUCT NUMBER	A	B	C
2203 Knob	1"	1-1/16"	19/32"
2205 Knob	1-1/4"	1-11/32"	23/32"
2207 Knob	1-1/2"	1-19/32"	7/8"

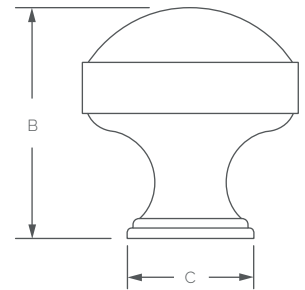
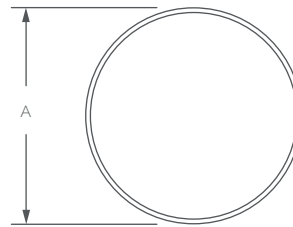

2209



2210

PRODUCT NUMBER	A	B	C
2209 Knob - Coin	1-1/4"	1-11/32"	7/8"
2210 Knob - Coin	1-1/2"	1-19/32"	7/8"

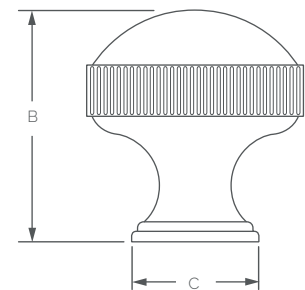
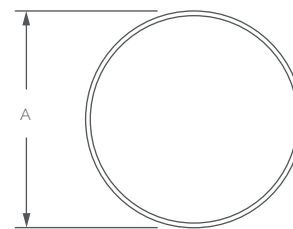

CABINET PULLS

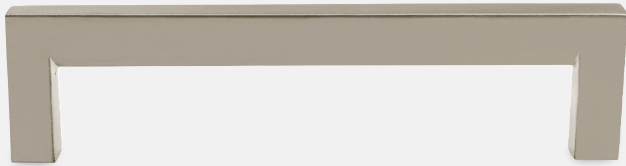

2226

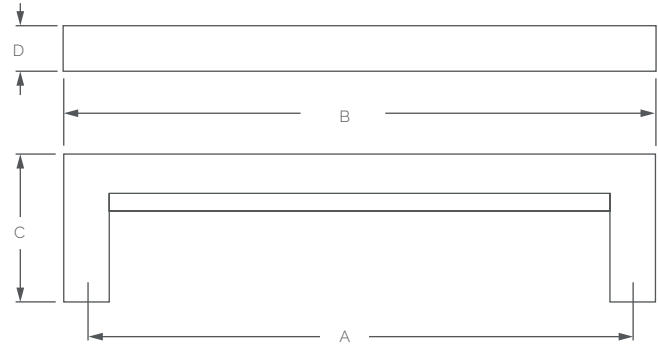

PRODUCT NUMBER	A	B	C	D
2224 Pull	4"	4-1/2"	1-5/8"	1/2"
2226 Pull	6"	6-1/2"	1-5/8"	1/2"
2228 Pull	8"	8-1/2"	1-5/8"	1/2"
2232 Pull	12"	12-1/2"	1-5/8"	1/2"
2238 Pull	18"	18-1/2"	1-5/8"	1/2"
2242 Appliance Pull	12"	12-7/8"	2-7/32"	7/8"
2248 Appliance Pull	18"	18-7/8"	2-7/32"	7/8"

REMEMBER

Appliance pulls are available as B-T-B and single sided applications.

BACKPLATES



2213

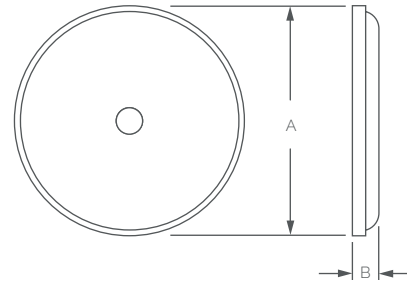

PRODUCT NUMBER	A	B
2213 Backplate	1-3/8"	3/16"



2215

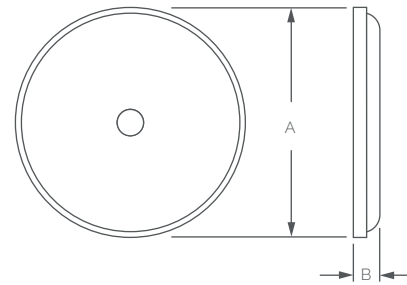

PRODUCT NUMBER	A	B
2215 Backplate	1-5/8"	3/16"

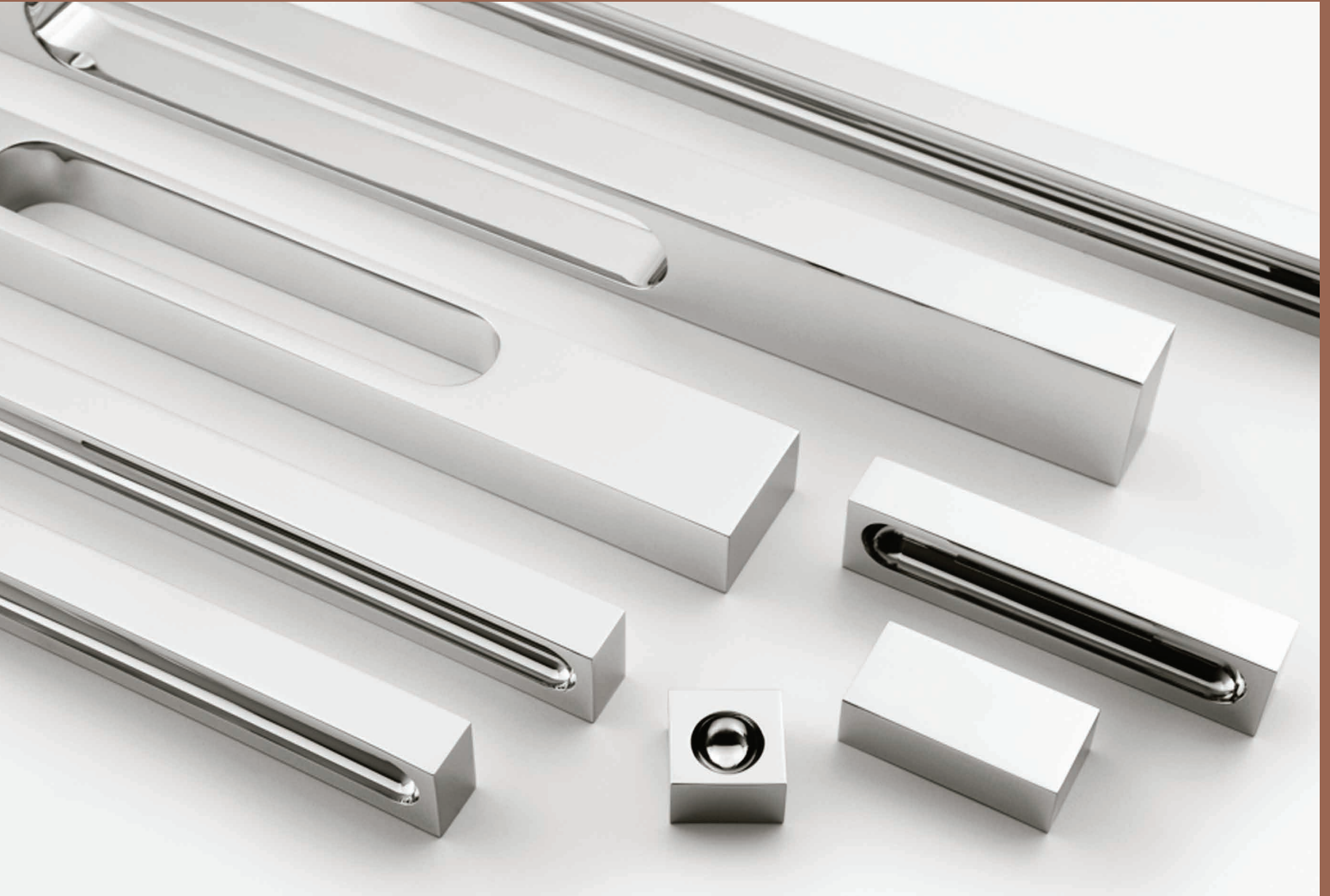

PORTSIDE



SURFACE PULLS

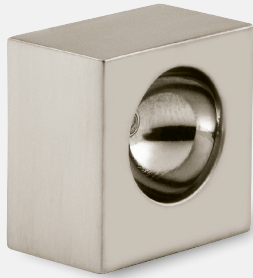

3102

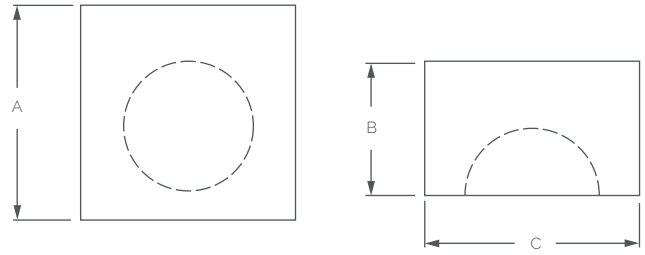

PRODUCT NUMBER	A	B	C
3102 Surface Pull	1"	5/8"	1"

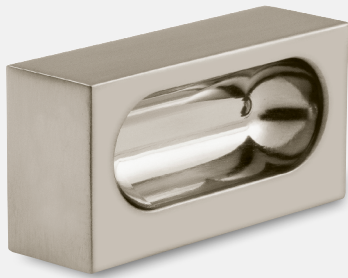

3106

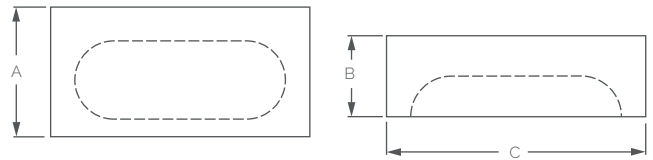

PRODUCT NUMBER	A	B	C
3106 Surface Pull	1"	5/8"	2"

SURFACE PULLS

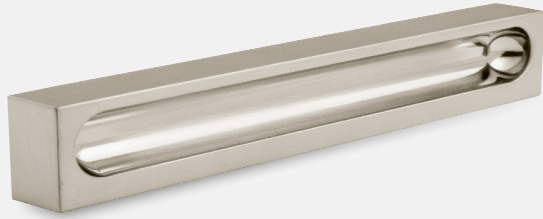

3116

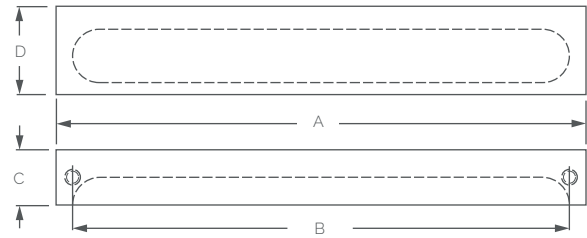

PRODUCT NUMBER	A	B	C	D
3114 Surface Pull	4"	3-5/8"	5/8"	1"
3116 Surface Pull	6"	5-5/8"	5/8"	1"
3118 Surface Pull	8"	7-5/8"	5/8"	1"
3119 Surface Pull	12"	11-5/8"	5/8"	1"
3120 Surface Pull	18"	17-5/8"	5/8"	1"

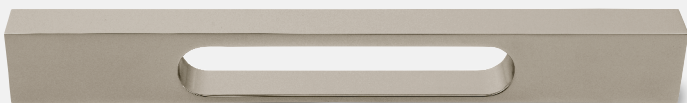

3121

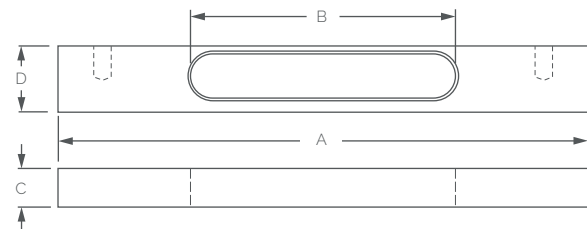

PRODUCT NUMBER	A	B	C	D
3121 Surface Appliance Pull	12"	6"	7/8"	1-1/2"
3122 Surface Appliance Pull	18"	8"	7/8"	1-1/2"
3124 Surface Appliance Pull	24"	8"	7/8"	1-1/2"
3130 Surface Appliance Pull	30"	10"	7/8"	1-1/2"
3136 Surface Appliance Pull	36"	12"	7/8"	1-1/2"

REMEMBER

Appliance pulls are available as B-T-B and single sided applications.



RIDGE



CABINET KNOBS & PULLS

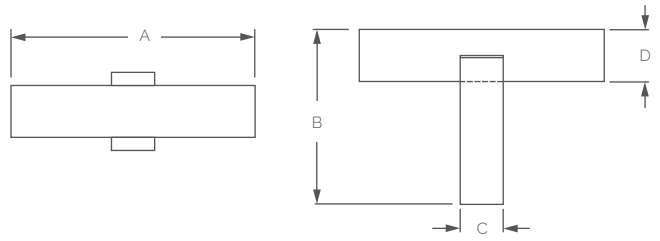

PRODUCT NUMBER	A	B	C	D
2706 T Knob	2"	1-11/16"	3/8"	1/2"

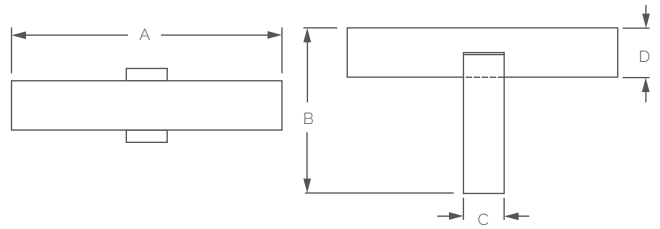

PRODUCT NUMBER	A	B	C	D
2708 T Pull	3-1/8"	1-11/16"	3/8"	1/2"

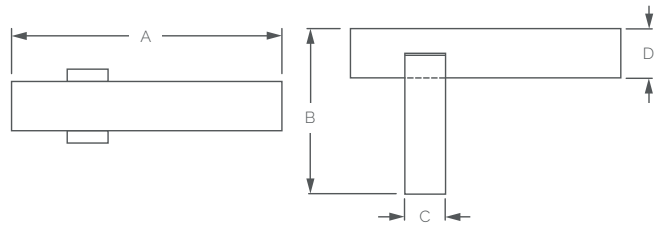

PRODUCT NUMBER	A	B	C	D
2710 L Pull	3-1/8"	1-11/16"	3/8"	1/2"

CABINET PULLS

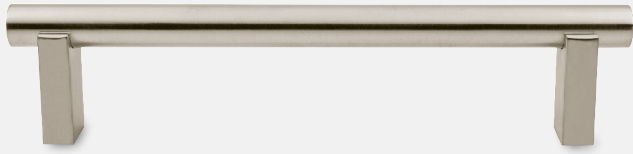

2716

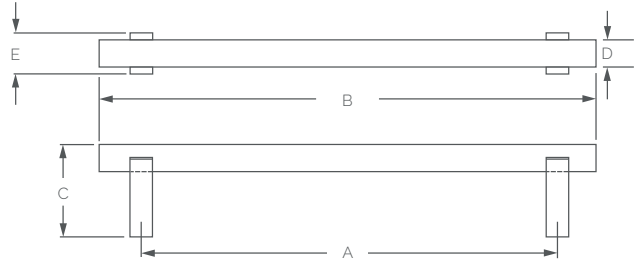

PRODUCT NUMBER	A	B	C	D	E
2714 Pull	4"	5-1/8"	1-11/16"	1/2"	3/4"
2716 Pull	6"	7-1/8"	1-11/16"	1/2"	3/4"
2718 Pull	8"	9-1/8"	1-11/16"	1/2"	3/4"
2722 Pull	12"	13-1/8"	1-11/16"	1/2"	3/4"
2728 Pull	18"	19-1/8"	1-11/16"	1/2"	3/4"
2732 Appliance Pull	12"	14-5/8"	2-3/4"	7/8"	1-1/4"
2738 Appliance Pull	18"	20-5/8"	2-3/4"	7/8"	1-1/4"
2744 Appliance Pull	24"	26-5/8"	2-3/4"	7/8"	1-1/4"
2750 Appliance Pull	30"	32-5/8"	2-3/4"	7/8"	1-1/4"
2756 Appliance Pull	36"	38-5/8"	2-3/4"	7/8"	1-1/4"

REMEMBER

Custom c-c sizes available.

Split finishes available.

Appliance pulls are available as B-T-B and single sided applications.

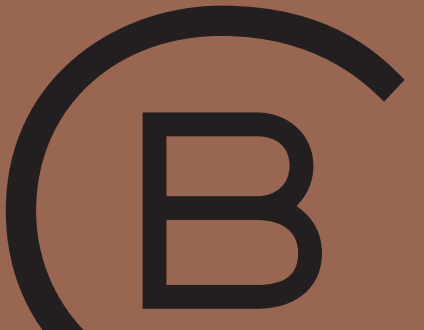

CABINET KNOBS & PULLS

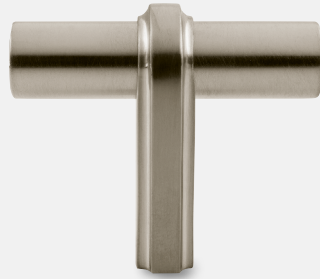

2806

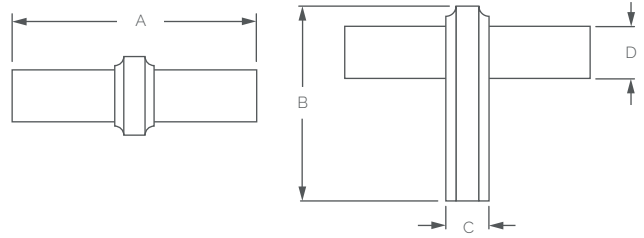

PRODUCT NUMBER	A	B	C	D
2806 T Knob	2"	1-11/16"	3/8"	1/2"

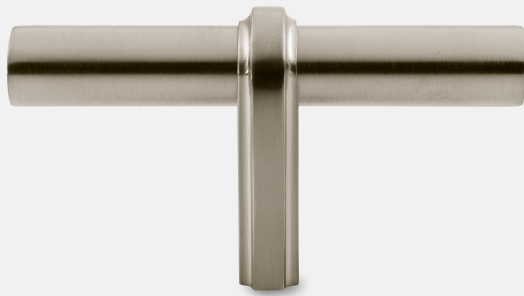

2808

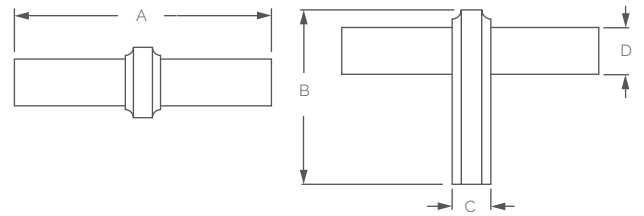

PRODUCT NUMBER	A	B	C	D
2808 T Pull	3-1/8"	1-11/16"	3/8"	1/2"

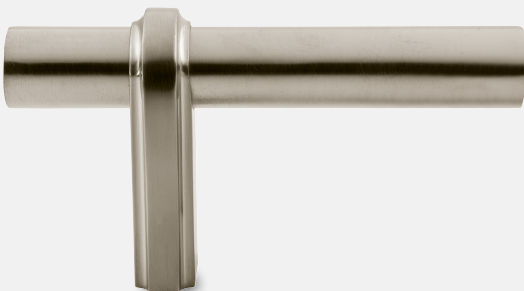

2810

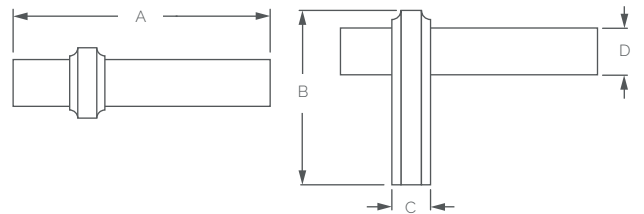

PRODUCT NUMBER	A	B	C	D
2810 L Pull	3-1/8"	1-11/16"	3/8"	1/2"

CABINET PULLS

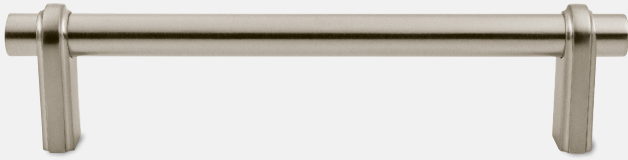

2816

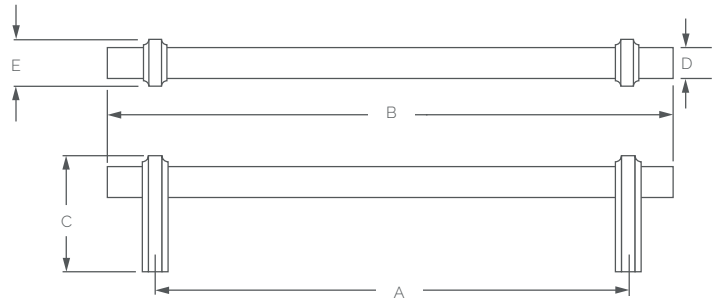

PRODUCT NUMBER	A	B	C	D	E
2814 Pull	4"	5-1/8"	1-11/16"	1/2"	3/4"
2816 Pull	6"	7-1/8"	1-11/16"	1/2"	3/4"
2818 Pull	8"	9-1/8"	1-11/16"	1/2"	3/4"
2822 Pull	12"	13-1/8"	1-11/16"	1/2"	3/4"
2828 Pull	18"	19-1/8"	1-11/16"	1/2"	3/4"
2832 Appliance Pull	12"	14-5/8"	2-3/4"	7/8"	1-1/4"
2838 Appliance Pull	18"	20-5/8"	2-3/4"	7/8"	1-1/4"
2844 Appliance Pull	24"	26-5/8"	2-3/4"	7/8"	1-1/4"
2850 Appliance Pull	30"	32-5/8"	2-3/4"	7/8"	1-1/4"
2856 Appliance Pull	36"	38-5/8"	2-3/4"	7/8"	1-1/4"

REMEMBER

Custom c-c sizes available.

Split finishes available.

Appliance pulls are available as B-T-B and single sided applications.

